

# Oracle® Multitenant Administrator's Guide



18c  
E84914-08  
March 2019

The Oracle logo, consisting of a solid red square with the word "ORACLE" in white, uppercase, sans-serif font centered within it.

ORACLE®

Oracle Multitenant Administrator's Guide, 18c

E84914-08

Copyright © 2017, 2019, Oracle and/or its affiliates. All rights reserved.

Primary Authors: Randy Urbano, Lance Ashdown

Contributing Authors: Patricia Huey, Roopesh Kumar, Bert Rich, Richard Strohm

Contributors: Penny Avril, Thomas Baby, Hermann Baer, Yasin Baskan, Dominique Djeunot, Andre Kruglikov, Kishy Kumar, Sue Lee, Siyu Liu, Bryn Llewellyn, Colin McGregor, John McHugh, Valarie Moore, Muthu Olagappan, Bhavesh Patel, Kumar Rajamani, Giridhar Ravipati, Can Tuzla, Patrick Wheeler

This software and related documentation are provided under a license agreement containing restrictions on use and disclosure and are protected by intellectual property laws. Except as expressly permitted in your license agreement or allowed by law, you may not use, copy, reproduce, translate, broadcast, modify, license, transmit, distribute, exhibit, perform, publish, or display any part, in any form, or by any means. Reverse engineering, disassembly, or decompilation of this software, unless required by law for interoperability, is prohibited.

The information contained herein is subject to change without notice and is not warranted to be error-free. If you find any errors, please report them to us in writing.

If this is software or related documentation that is delivered to the U.S. Government or anyone licensing it on behalf of the U.S. Government, then the following notice is applicable:

U.S. GOVERNMENT END USERS: Oracle programs, including any operating system, integrated software, any programs installed on the hardware, and/or documentation, delivered to U.S. Government end users are "commercial computer software" pursuant to the applicable Federal Acquisition Regulation and agency-specific supplemental regulations. As such, use, duplication, disclosure, modification, and adaptation of the programs, including any operating system, integrated software, any programs installed on the hardware, and/or documentation, shall be subject to license terms and license restrictions applicable to the programs. No other rights are granted to the U.S. Government.

This software or hardware is developed for general use in a variety of information management applications. It is not developed or intended for use in any inherently dangerous applications, including applications that may create a risk of personal injury. If you use this software or hardware in dangerous applications, then you shall be responsible to take all appropriate fail-safe, backup, redundancy, and other measures to ensure its safe use. Oracle Corporation and its affiliates disclaim any liability for any damages caused by use of this software or hardware in dangerous applications.

Oracle and Java are registered trademarks of Oracle and/or its affiliates. Other names may be trademarks of their respective owners.

Intel and Intel Xeon are trademarks or registered trademarks of Intel Corporation. All SPARC trademarks are used under license and are trademarks or registered trademarks of SPARC International, Inc. AMD, Opteron, the AMD logo, and the AMD Opteron logo are trademarks or registered trademarks of Advanced Micro Devices. UNIX is a registered trademark of The Open Group.

This software or hardware and documentation may provide access to or information about content, products, and services from third parties. Oracle Corporation and its affiliates are not responsible for and expressly disclaim all warranties of any kind with respect to third-party content, products, and services unless otherwise set forth in an applicable agreement between you and Oracle. Oracle Corporation and its affiliates will not be responsible for any loss, costs, or damages incurred due to your access to or use of third-party content, products, or services, except as set forth in an applicable agreement between you and Oracle.

# Contents

## Preface

---

Audience	xxi
Documentation Accessibility	xxi
Related Documents	xxi
Conventions	xxii

## Changes in This Release for Oracle Multitenant Administrator's Guide

---

Changes in Oracle Database Release 18c, Version 18.1	xxiii
Changes in Oracle Database 12c Release 2 (12.2.0.1)	xxv
Changes in Oracle Database 12c Release 1 (12.1.0.2)	xxvii
Changes in Oracle Database 12c Release 1 (12.1.0.1)	xxviii

## Part I Multitenant Architecture

---

### 1 Introduction to the Multitenant Architecture

---

1.1 About the Multitenant Architecture	1-1
1.1.1 About Containers in a CDB	1-1
1.1.2 About User Interfaces for the Multitenant Architecture	1-4
1.2 Benefits of the Multitenant Architecture	1-5
1.2.1 Challenges for a Non-CDB Architecture	1-6
1.2.2 Benefits of the Multitenant Architecture for Database Consolidation	1-7
1.2.3 Benefits of the Multitenant Architecture for Manageability	1-9
1.3 Path to Database Consolidation	1-10
1.3.1 Creation of a CDB	1-11
1.3.2 Creation of a PDB	1-12
1.3.2.1 Creation of a PDB by Cloning	1-12
1.3.2.2 Creation of a PDB by Plugging In	1-16
1.3.2.3 Creation of a PDB by Relocating	1-20
1.3.2.4 Creation of a PDB as a Proxy PDB	1-22

## 2 Overview of the Multitenant Architecture

---

2.1	Overview of Containers in a CDB	2-1
2.1.1	The CDB Root and System Container	2-2
2.1.2	PDBs	2-3
2.1.2.1	Types of PDBs	2-3
2.1.2.2	Purpose of PDBs	2-5
2.1.2.3	Proxy PDBs	2-5
2.1.2.4	Names for PDBs	2-6
2.1.2.5	Database Links Between PDBs	2-7
2.1.3	Data Dictionary Architecture in a CDB	2-8
2.1.3.1	Purpose of Data Dictionary Separation	2-9
2.1.3.2	Metadata and Data Links	2-10
2.1.3.3	Container Data Objects in a CDB	2-11
2.1.3.4	Data Dictionary Storage in a CDB	2-14
2.1.4	Current Container	2-14
2.1.5	Cross-Container Operations	2-14
2.2	Overview of Commonality in the CDB	2-15
2.2.1	About Commonality in a CDB	2-16
2.2.1.1	Principles of Commonality	2-16
2.2.1.2	Namespaces in a CDB	2-17
2.2.2	Overview of Common and Local Users in a CDB	2-18
2.2.2.1	Common Users in a CDB	2-19
2.2.2.2	Local Users in a CDB	2-21
2.2.3	Overview of Common and Local Roles in a CDB	2-23
2.2.3.1	Common Roles in a CDB	2-23
2.2.3.2	Local Roles in a CDB	2-24
2.2.4	Overview of Privilege and Role Grants in a CDB	2-24
2.2.4.1	Principles of Privilege and Role Grants in a CDB	2-25
2.2.4.2	Privileges and Roles Granted Locally in a CDB	2-25
2.2.4.3	Roles and Privileges Granted Commonly in a CDB	2-27
2.2.4.4	Grants to PUBLIC in a CDB	2-29
2.2.4.5	Grants of Privileges and Roles: Scenario	2-30
2.2.5	Overview of Common and Local Objects in a CDB	2-33
2.2.6	Overview of Common Audit Configurations	2-34
2.2.7	Overview of PDB Lockdown Profiles	2-35
2.3	Overview of Applications in an Application Container	2-37
2.3.1	About Application Containers	2-38
2.3.1.1	Purpose of Application Containers	2-39



2.3.1.2	Application Root	2-42
2.3.1.3	Application PDBs	2-43
2.3.1.4	Application Seed	2-43
2.3.2	Application Common Objects	2-44
2.3.2.1	Creation of Application Common Objects	2-45
2.3.2.2	Metadata-Linked Application Common Objects	2-45
2.3.2.3	Data-Linked Application Common Objects	2-47
2.3.2.4	Extended Data-Linked Application Objects	2-48
2.3.3	Application Maintenance	2-50
2.3.3.1	About Application Maintenance	2-50
2.3.3.2	Application Installation	2-51
2.3.3.3	Application Upgrade	2-52
2.3.3.4	Application Patch	2-56
2.3.4	Migration of an Existing Application	2-57
2.3.5	Implicitly Created Applications	2-58
2.3.6	Application Synchronization	2-58
2.3.7	Container Maps	2-59
2.4	Overview of Services in a CDB	2-62
2.4.1	Service Creation in a CDB	2-63
2.4.1.1	Default Services in a CDB	2-64
2.4.1.2	Nondefault Services in a CDB	2-64
2.4.2	Connections to Containers in a CDB	2-65
2.5	Overview of Tablespaces and Database Files in a CDB	2-66
2.6	Overview of Availability in a CDB	2-68
2.6.1	Overview of Backup and Recovery in a CDB	2-69
2.6.2	Overview of Flashback PDB in a CDB	2-69
2.7	Overview of Oracle Resource Manager in a CDB	2-70

## Part II Creating and Configuring a Multitenant Environment

---

### 3 Overview of Configuring and Managing a Multitenant Environment

---

3.1	About Configuring and Managing a Multitenant Environment	3-1
3.1.1	Common Users and Local Users	3-2
3.1.2	Separation of Duties in CDB and PDB Administration	3-2
3.2	Prerequisites for a Multitenant Environment	3-2
3.3	Tasks and Tools for a Multitenant Environment	3-3
3.3.1	Tasks for a Multitenant Environment	3-3
3.3.2	Tools for a Multitenant Environment	3-6

## 4 Creating and Configuring a CDB

---

4.1	About Creating a CDB	4-1
4.2	Planning for CDB Creation	4-2
4.2.1	Decide How to Configure the CDB	4-2
4.2.1.1	Plan the PDBs	4-3
4.2.1.2	Plan the Physical Layout	4-3
4.2.1.3	Learn How to Manage Initialization Parameters	4-4
4.2.1.4	Select the Character Set	4-5
4.2.1.5	Decide Which Time Zones to Support	4-5
4.2.1.6	Select the Database and Redo Log Block Sizes	4-6
4.2.1.7	Plan the SYSTEM and SYSAUX Tablespaces	4-6
4.2.1.8	Plan the Temporary Tablespaces	4-6
4.2.1.9	Choose the Undo Mode	4-7
4.2.1.10	Plan the Services for Your Application	4-8
4.2.1.11	Learn How to Start Up and Shut Down a CDB	4-8
4.2.1.12	Plan for Oracle RAC	4-9
4.2.2	Prerequisites for CDB Creation	4-9
4.3	Creating a CDB	4-9
4.3.1	About CDB Creation with DBCA	4-10
4.3.2	About CDB Creation with SQL Statements	4-11
4.3.2.1	About Enabling PDBs	4-12
4.3.2.2	About the Names and Locations of the Files for Root and the PDB Seed	4-12
4.3.2.3	About the Attributes of the Data Files for PDB\$SEED	4-14
4.3.2.4	About the CDB Undo Mode	4-15
4.3.3	Creating a CDB with the CREATE DATABASE Statement	4-16
4.3.4	Creating a CDB with the CREATE DATABASE Statement: Examples	4-17
4.3.4.1	Creating a CDB Without Using Oracle Managed Files	4-18
4.3.4.2	Creating a CDB Using Oracle Managed Files: Example	4-21
4.4	Configuring EM Express for a CDB	4-23
4.5	After Creating a CDB	4-25

## Part III Creating and Removing PDBs and Application Containers

---

### 5 Overview of PDB Creation

---

5.1	Techniques for Creating a PDB	5-1
5.1.1	Current Container and PDB Creation	5-3
5.1.2	Options for Creating a PDB from a Non-CDB	5-4
5.2	PDB Storage	5-5

5.2.1	Storage Limits	5-5
5.2.2	Default Tablespace	5-6
5.2.3	User Tablespaces	5-6
5.2.4	PDB File Locations	5-8
5.2.4.1	FILE_NAME_CONVERT Clause	5-10
5.2.4.2	CREATE_FILE_DEST Clause	5-11
5.2.4.3	Restrictions on PDB File Locations	5-12
5.3	Service Name Conversion	5-13
5.4	Summary of Clauses for Creating a PDB	5-14
5.5	General Prerequisites for PDB Creation	5-21

## 6 Creating a PDB from Scratch

---

6.1	About Creating a PDB from Scratch	6-1
6.2	Creating a PDB	6-4
6.3	Creating a PDB: Examples	6-5
6.3.1	Creating a PDB Using No Clauses: Example	6-6
6.3.2	Creating a PDB and Granting Predefined Oracle Roles to the PDB Administrator: Example	6-6
6.3.3	Creating a PDB Using Multiple Clauses: Example	6-7

## 7 Cloning a PDB or Non-CDB

---

7.1	About Cloning a PDB	7-1
7.1.1	About Cloning a Local PDB	7-3
7.1.2	About Cloning a Remote PDB	7-4
7.1.3	About Cloning a Non-CDB	7-5
7.1.4	About Cloning an Application PDB	7-6
7.1.5	About Refreshable Clone PDBs	7-7
7.1.5.1	Purpose of Refreshable Clone PDBs	7-8
7.1.5.2	Automatic and Manual Refresh Modes	7-8
7.1.5.3	Requirements for Refreshable Clone PDBs	7-9
7.1.6	About Cloning PDBs from PDB Snapshots	7-10
7.1.7	About Snapshot Copy PDBs	7-11
7.1.7.1	How a Snapshot Copy PDB Differs from a Standard Clone	7-11
7.1.7.2	Storage Requirements for Snapshot Copy PDBs	7-12
7.1.8	About Split Mirror Clone PDBs	7-13
7.2	Cloning a Local PDB: Basic Steps	7-14
7.3	Cloning a Local PDB: Examples	7-16
7.3.1	Cloning a Local PDB Using No Clauses: Example	7-16
7.3.2	Cloning a Local PDB Using DBCA: Example	7-17
7.3.3	Cloning a Local PDB with the PATH_PREFIX Clause: Example	7-18

7.3.4	Cloning a Local PDB Using the STORAGE Clause: Example	7-19
7.3.5	Cloning a Local PDB with the NO DATA Clause: Example	7-19
7.3.6	Cloning a PDB from a PDB Snapshot: Scenario	7-20
7.3.7	Creating a Snapshot Copy PDB: Example	7-21
7.4	Cloning a Remote PDB: Basic Steps	7-22
7.5	Cloning a Remote PDB or Non-CDB: Examples	7-24
7.5.1	Cloning a Remote PDB Using No Clauses: Example	7-25
7.5.2	Cloning a Remote Non-CDB: Example	7-26
7.5.3	Creating a Refreshable Clone: Example	7-26
7.6	After Cloning a PDB	7-27
7.7	Materializing a Snapshot Copy PDB	7-28

## 8 Relocating a PDB

---

8.1	About PDB Relocation	8-1
8.2	Purpose of PDB Relocation	8-4
8.3	How PDB Relocation Works	8-4
8.3.1	Server Session Draining When Relocating or Stopping PDBs	8-5
8.3.2	Stages of PDB Relocation	8-5
8.3.2.1	PDB Relocation in a Common Listener Network	8-6
8.3.2.2	PDB Relocation in Isolated Listener Networks	8-7
8.4	Creating a PDB by Relocating It	8-9

## 9 Plugging In an Unplugged PDB

---

9.1	About Plugging In an Unplugged PDB	9-1
9.1.1	About the XML File and Archive File	9-1
9.1.2	Source File Locations When Plugging In an Unplugged PDB	9-4
9.1.2.1	SOURCE_FILE_NAME_CONVERT Clause	9-4
9.1.2.2	SOURCE_FILE_DIRECTORY Clause	9-5
9.2	About Adopting a Non-CDB as a PDB	9-6
9.3	Plugging In an Unplugged PDB	9-8
9.4	Adopting a Non-CDB as a PDB	9-11
9.5	After Plugging in an Unplugged PDB	9-13
9.6	Plugging in an Unplugged PDB: Examples	9-14

## 10 Creating a PDB as a Proxy PDB

---

10.1	About Creating a Proxy PDB	10-1
10.1.1	Proxy PDBs and SQL Statements	10-4
10.1.2	Proxy PDBs and Database Links	10-4
10.1.3	Proxy PDBs and Authentication	10-5

10.1.4	Proxy PDBs and the Listener	10-5
10.1.4.1	HOST Clause	10-5
10.1.4.2	PORT Clause	10-6
10.2	Creating a Proxy PDB	10-7

## 11 Removing a PDB

---

11.1	Unplugging a PDB from a CDB	11-1
11.1.1	About Unplugging a PDB	11-1
11.1.2	Unplugging a PDB	11-4
11.2	Dropping a PDB	11-5

## 12 Creating and Removing Application Containers and Seeds

---

12.1	Creating and Removing Application Containers	12-1
12.1.1	Creating Application Containers	12-2
12.1.1.1	About Creating an Application Container	12-2
12.1.1.2	Preparing for Application Containers	12-3
12.1.1.3	Creating an Application Container	12-4
12.1.2	Unplugging an Application Container from a CDB	12-7
12.1.2.1	About Unplugging an Application Container	12-7
12.1.2.2	Unplugging an Application Container	12-8
12.1.3	Dropping an Application Container	12-9
12.2	Creating and Removing Application Seeds	12-11
12.2.1	Creating Application Seeds	12-11
12.2.1.1	About Creating an Application Seed	12-11
12.2.1.2	Preparing for an Application Seed	12-12
12.2.1.3	Creating an Application Seed	12-13
12.2.2	Unplugging an Application Seed from an Application Container	12-16
12.2.2.1	About Unplugging an Application Seed	12-17
12.2.2.2	Unplugging an Application Seed	12-18
12.2.3	Dropping an Application Seed	12-18
12.3	Creating an Application PDB	12-20

## Part IV Administering a Multitenant Environment

---

### 13 Administering a CDB

---

13.1	About CDB Administration	13-1
13.1.1	About the Current Container	13-2
13.1.2	About Administrative Tasks in a CDB	13-3

13.1.3	About Using Manageability Features in a CDB	13-7
13.1.4	About Managing Tablespaces in a CDB	13-12
13.1.4.1	About Managing Permanent Tablespaces in a CDB	13-12
13.1.4.2	About Managing Temporary Tablespaces in a CDB	13-13
13.1.5	About Managing Database Objects in a CDB	13-13
13.1.6	About Flashing Back a PDB	13-14
13.1.7	About Restricting PDB Users for Enhanced Security	13-14
13.1.7.1	PDB Lockdown Profiles	13-15
13.1.7.2	The PDB_OS_CREDENTIAL Initialization Parameter	13-16
13.1.7.3	The PATH_PREFIX and CREATE_FILE_DEST PDB Creation Clauses	13-17
13.1.8	Overview of Oracle Multitenant with Oracle RAC	13-17
13.2	Accessing Containers in a CDB	13-18
13.2.1	About Container Access in a CDB	13-18
13.2.1.1	Services in a CDB	13-19
13.2.1.2	Session Limits in a CDB	13-20
13.2.1.3	User Names in a Multitenant Environment	13-20
13.2.1.4	How the Multitenant Option Affects Password Files for Administrative Users	13-21
13.2.2	Accessing a Container in a CDB	13-21
13.2.2.1	Connecting to a Container Using the SQL*Plus CONNECT Command	13-21
13.2.2.2	Switching to a Container Using the ALTER SESSION Statement	13-24
13.3	Modifying a CDB at the System Level	13-28
13.3.1	About System-Level Modifications of a CDB	13-28
13.3.2	Modifying a CDB with ALTER SYSTEM	13-29
13.4	Modifying Containers When Connected to the CDB Root	13-30
13.4.1	About Container Modification When Connected to CDB Root	13-30
13.4.2	Modifying an Entire CDB Using ALTER DATABASE	13-31
13.4.3	Setting the Undo Mode in a CDB Using ALTER DATABASE	13-32
13.4.3.1	About the CDB Undo Mode	13-33
13.4.3.2	Configuring a CDB to Use Local Undo Mode	13-34
13.4.3.3	Configuring a CDB to Use Shared Undo Mode	13-35
13.4.4	Modifying the CDB Root Using ALTER DATABASE	13-36
13.4.5	Modifying the Open Mode of One or More PDBs	13-37
13.4.5.1	About the Open Mode of a PDB	13-38
13.4.5.2	Modifying the Open Mode of PDBs with ALTER PLUGGABLE DATABASE	13-45
13.4.5.3	Modifying the Open Mode of PDBs with the SQL*Plus STARTUP Command	13-47
13.4.5.4	Preserving or Discarding the Open Mode of PDBs When the CDB Restarts	13-48
13.4.5.5	Starting and Stopping PDBs in Oracle RAC	13-50

13.5	Executing SQL in a Different Container	13-51
13.5.1	Issuing DML Statements on a Container in a CDB	13-51
13.5.1.1	About Issuing DML Statements on a Container in a CDB	13-51
13.5.1.2	Specifying the Default Container for DML Statements in a CDB	13-52
13.5.2	Executing DDL Statements in a CDB	13-53
13.5.2.1	About Executing DDL Statements in a CDB	13-53
13.5.2.2	Executing a DDL Statement in the Current Container	13-55
13.5.2.3	Executing a DDL Statement in All Containers in a CDB	13-56
13.5.3	Running Oracle-Supplied SQL Scripts in a CDB	13-56
13.5.3.1	About Running Oracle-Supplied SQL Scripts in a CDB	13-57
13.5.3.2	Syntax and Parameters for catcon.pl	13-57
13.5.3.3	Running the catcon.pl Script	13-60
13.5.4	Executing Code in Containers Using the DBMS_SQL Package	13-63
13.6	Shutting Down a CDB Instance	13-64

## 14 Administering a CDB Fleet

---

14.1	About CDB Fleets	14-1
14.2	Purpose of a CDB Fleet	14-3
14.3	Setting the Lead CDB in a CDB Fleet	14-4
14.4	Designating a CDB Fleet Member	14-4

## 15 Administering PDBs

---

15.1	About PDB Administration	15-1
15.1.1	Tasks Common to PDBs and Non-CDBs	15-2
15.1.2	Tasks Specific to CDBs	15-3
15.2	Managing Connections to a PDB	15-4
15.2.1	Connecting to a PDB	15-4
15.2.2	Managing Services for PDBs	15-5
15.2.2.1	About Services for PDBs	15-6
15.2.2.2	Managing Services for a PDB Using SRVCTL and DBMS_SERVICE	15-9
15.2.3	Modifying the Listener Settings of a Referenced PDB	15-11
15.2.3.1	Altering the Listener Host Name of a Referenced PDB	15-12
15.2.3.2	Altering the Listener Port Number of a Referenced PDB	15-13
15.3	Modifying a PDB at the System Level	15-14
15.3.1	About System-Level Modifications of a PDB	15-14
15.3.2	Modifying a PDB with ALTER SYSTEM	15-16
15.4	Modifying a PDB at the Database Level	15-16
15.4.1	About Database-Level Modifications of a PDB	15-17
15.4.1.1	Storage Clauses	15-17

15.4.1.2	Logging and Recovery Clauses	15-18
15.4.1.3	Miscellaneous Clauses	15-20
15.4.2	Modifying a PDB with the ALTER PLUGGABLE DATABASE Statement	15-21
15.4.3	Changing the Global Database Name of a PDB	15-24
15.4.4	Managing Refreshable Clone PDBs	15-25
15.4.4.1	Refreshing a PDB	15-25
15.4.4.2	Switching Over a Refreshable Clone PDB	15-26
15.5	Starting Up and Shutting Down a PDB	15-30
15.5.1	Starting Up a PDB Using the STARTUP Command	15-30
15.5.2	Shutting Down a PDB Using the SHUTDOWN Command	15-31

## 16 Administering a PDB Snapshot Carousel

---

16.1	About PDB Snapshot Carousel	16-1
16.1.1	Purpose of PDB Snapshot Carousel	16-2
16.1.2	How PDB Snapshot Carousel Works	16-4
16.1.2.1	Contents of a PDB Snapshot	16-5
16.1.2.2	Contents of a PDB Snapshot Carousel	16-5
16.1.3	User Interface for PDB Snapshot Carousel	16-6
16.2	Setting the Maximum Number of Snapshots in a PDB Snapshot Carousel	16-8
16.3	Configuring Automatic PDB Snapshots	16-9
16.4	Creating PDB Snapshots Manually	16-11
16.5	Dropping a PDB Snapshot	16-13

## 17 Administering Application Containers

---

17.1	About Application Container Administration	17-2
17.2	About Modifying an Application Root	17-4
17.3	Managing Applications in an Application Container	17-6
17.3.1	About Application Management	17-7
17.3.1.1	Basic Steps of Application Maintenance	17-7
17.3.1.2	Application Versions	17-8
17.3.1.3	Application Module Names	17-8
17.3.2	Installing Applications in an Application Container	17-10
17.3.2.1	About Installing Applications in an Application Container	17-10
17.3.2.2	Installing an Application in an Application Container with Automated Propagation	17-10
17.3.3	Upgrading Applications in an Application Container	17-11
17.3.3.1	About Upgrading Applications in an Application Container	17-12
17.3.3.2	Upgrading an Application in an Application Container	17-14
17.3.4	Patching Applications in an Application Container	17-15



17.3.4.1	About Patching Applications in an Application Container	17-15
17.3.4.2	Patching an Application in an Application Container with Automated Propagation	17-16
17.3.5	Migrating an Existing Application to an Application Container	17-17
17.3.5.1	About Migrating an Existing Application to an Application Container	17-18
17.3.5.2	Creating an Application Root Using an Existing PDB	17-19
17.3.5.3	Creating an Application PDB Using an Existing PDB	17-20
17.3.6	Synchronizing Applications in an Application PDB	17-21
17.3.7	Synchronizing an Application Root Replica with a Proxy PDB	17-22
17.3.7.1	About Synchronizing an Application Root Replica with a Proxy PDB	17-22
17.3.7.2	Creating a Proxy PDB That References an Application Root Replica	17-25
17.3.8	Setting the Compatibility Version of an Application	17-31
17.3.9	Performing Bulk Inserts During Application Install, Upgrade, and Patch Operations	17-32
17.3.10	Uninstalling Applications from an Application Container	17-34
17.3.10.1	About Uninstalling Applications from an Application Container	17-34
17.3.10.2	Uninstalling an Application from an Application Container	17-35
17.4	Managing Application Common Objects	17-36
17.4.1	About Application Common Objects	17-37
17.4.1.1	Creation of Application Common Objects	17-38
17.4.1.2	About Metadata-Linked Application Common Objects	17-39
17.4.1.3	About Extended Data-Linked Application Common Objects	17-39
17.4.1.4	About Extended Data-Linked Application Common Objects	17-40
17.4.2	Restrictions for Application Common Objects	17-41
17.4.3	Creating Application Common Objects	17-41
17.4.4	Issuing DML Statements on Application Common Objects	17-44
17.4.4.1	Issuing DML on Metadata-Linked Common Objects	17-45
17.4.4.2	Issuing DML on Data-Linked Common Objects	17-47
17.4.5	Modifying Application Common Objects with DDL Statements	17-48
17.5	Issuing DML Statements on Containers in an Application Container	17-49
17.5.1	About Issuing DML Statements on Containers in an Application Container	17-50
17.5.2	Specifying the Default Container for DML Statements in an Application Container	17-51
17.6	Partitioning by PDB with Container Maps	17-52
17.6.1	About Container Maps	17-52
17.6.1.1	Map Objects	17-53
17.6.1.2	List-Partitioned Container Map: Example	17-53
17.6.1.3	Range-Partitioned Container Map: Example	17-54

## 18 Managing Security for a Multitenant Environment

---

18.1	Managing Security for a Multitenant Environment	18-1
18.1.1	Managing Commonly and Locally Granted Privileges	18-1
18.1.1.1	How the Oracle Multitenant Option Affects Privileges	18-2
18.1.1.2	About Commonly and Locally Granted Privileges	18-3
18.1.1.3	How Commonly Granted System Privileges Work	18-3
18.1.1.4	How Commonly Granted Object Privileges Work	18-4
18.1.1.5	Granting or Revoking Privileges to Access a PDB	18-5
18.1.1.6	Example: Granting a Privilege in a Multitenant Environment	18-5
18.1.1.7	Enabling Common Users to View CONTAINER_DATA Object Information	18-5
18.1.2	Managing Common Roles and Local Roles	18-8
18.1.2.1	About Common Roles and Local Roles	18-8
18.1.2.2	How Common Roles Work	18-8
18.1.2.3	How the PUBLIC Role Works in a Multitenant Environment	18-9
18.1.2.4	Privileges Required to Create, Modify, or Drop a Common Role	18-9
18.1.2.5	Rules for Creating Common Roles	18-9
18.1.2.6	Creating a Common Role	18-9
18.1.2.7	Rules for Creating Local Roles	18-10
18.1.2.8	Creating a Local Role	18-10
18.1.2.9	Role Grants and Revokes for Common Users and Local Users	18-10
18.1.3	Restricting Operations on PDBs Using PDB Lockdown Profiles	18-11
18.1.3.1	About PDB Lockdown Profiles	18-12
18.1.3.2	Default PDB Lockdown Profiles	18-13
18.1.3.3	Creating a PDB Lockdown Profile	18-14
18.1.3.4	Enabling or Disabling a PDB Lockdown Profile	18-15
18.1.3.5	Dropping a PDB Lockdown Profile	18-17
18.2	Using Application Contexts in a Multitenant Environment	18-18
18.2.1	What Is an Application Context?	18-18
18.2.2	Application Contexts in a Multitenant Environment	18-18
18.3	Using Oracle Virtual Private Database in a Multitenant Environment	18-20
18.3.1	What Is Oracle Virtual Private Database?	18-20
18.3.2	Oracle Virtual Private Database in a Multitenant Environment	18-21
18.4	Using Transport Layer Security in a Multitenant Environment	18-21
18.5	Oracle Data Redaction in a Multitenant Environment	18-22
18.6	Auditing in a Multitenant Environment	18-22
18.6.1	About Auditing in a Multitenant Environment	18-22
18.6.2	Example: Auditing the DBA Role in a Multitenant Environment	18-23
18.6.3	Unified Audit Policies or AUDIT Settings in a Multitenant Environment	18-23

18.6.3.1		18-24
18.6.3.2	Traditional Auditing in a Multitenant Environment	18-24
18.6.3.3	Configuring a Local Unified Audit Policy or Common Unified Audit Policy	18-25
18.6.3.4	Example: Local Unified Audit Policy	18-26
18.6.3.5	Example: CDB Common Unified Audit Policy	18-26
18.6.3.6	Example: Application Common Unified Audit Policy	18-27
18.6.3.7	How Local or Common Audit Policies or Settings Appear in the Audit Trail	18-27
18.6.4	Fine-Grained Auditing in a Multitenant Environment	18-28

## 19 Monitoring CDBs and PDBs

---

19.1	About CDB and Container Information in Views	19-2
19.1.1	About Viewing Information When the Current Container Is Not the CDB Root	19-2
19.1.2	About Viewing Information When the Current Container Is the CDB Root	19-3
19.1.3	Views for a CDB	19-4
19.2	Determining Whether a Database Is a CDB	19-7
19.3	Viewing Information About the Containers in a CDB	19-8
19.4	Viewing Information About PDBs	19-8
19.5	Viewing the Open Mode of Each PDB	19-9
19.6	Querying Container Data Objects	19-10
19.7	Querying Across Containers with the CONTAINERS Clause	19-14
19.7.1	About Querying Across Containers with the CONTAINERS Clause	19-14
19.7.2	Querying User-Created Tables and Views Across All Containers	19-16
19.7.3	Querying Application Common Objects Across Application PDBs	19-18
19.8	Determining the Current Container ID or Name	19-19
19.9	Listing the Modifiable Initialization Parameters in PDBs	19-20
19.10	Viewing the History of PDBs	19-21
19.11	Viewing Information About Applications in Application Containers	19-22
19.11.1	Viewing Information About Applications	19-23
19.11.2	Viewing Information About Application Status	19-24
19.11.3	Viewing Information About Application Statements	19-25
19.11.4	Viewing Information About Application Versions	19-27
19.11.5	Viewing Information About Application Patches	19-28
19.11.6	Viewing Information About Application Errors	19-29
19.11.7	Listing the Shared Database Objects in an Application Container	19-29
19.11.8	Listing the Extended Data-Linked Objects in an Application Container	19-30

### 20 Backing Up and Recovering CDBs and PDBs

---

20.1	Overview of Backing Up and Recovering CDBs and PDBs	20-1
20.2	Backup and Complete Recovery of CDBs	20-2
20.3	Backup and Complete Recovery of PDBs	20-3
20.4	Point-in-Time Recovery in a Multitenant Environment	20-4
20.5	Flashback Database in a Multitenant Environment	20-5

### 21 Using Oracle Resource Manager for PDBs

---

21.1	Overview of Oracle Resource Manager in a Multitenant Environment	21-2
21.1.1	Purpose of Resource Management in a Multitenant Environment	21-3
21.1.2	Overview of Resource Plan Directives	21-4
21.1.2.1	PDB Performance Profiles	21-4
21.1.2.2	Resource Plan Directives	21-5
21.1.3	Background and Administrative Tasks and Consumer Groups	21-5
21.1.4	Initialization Parameters for Multitenant Resource Management	21-6
21.1.4.1	Memory-Related Initialization Parameters for PDBs	21-6
21.1.4.2	I/O-Related Initialization Parameters for PDBs	21-9
21.1.4.3	CPU-Related Initialization Parameters for PDBs	21-11
21.2	Managing CDB Resource Plans	21-11
21.2.1	About CDB Resource Plans	21-12
21.2.1.1	Shares for Allocating Resources to PDBs	21-12
21.2.1.2	Utilization Limits for PDBs	21-13
21.2.1.3	The Default Directive for PDBs	21-16
21.2.2	Creating a CDB Resource Plan for Managing PDBs	21-18
21.2.3	Creating a CDB Resource Plan for Managing PDBs: Scenario	21-18
21.2.4	Creating a CDB Resource Plan with PDB Performance Profiles	21-21
21.2.5	Creating a CDB Resource Plan for PDB Performance Profiles: Scenario	21-22
21.2.6	Enabling a CDB Resource Plan	21-25
21.2.7	Modifying a CDB Resource Plan	21-26
21.2.7.1	Updating a CDB Resource Plan	21-26
21.2.7.2	Managing CDB Resource Plan Directives for a PDB	21-27
21.2.7.3	Managing CDB Resource Plan Directives for a PDB Performance Profile	21-31
21.2.7.4	Updating the Default Directive for PDBs in a CDB Resource Plan	21-34
21.2.7.5	Updating the Default Directive for Maintenance Tasks in a CDB Resource Plan	21-35

21.2.7.6	Deleting a CDB Resource Plan	21-36
21.2.8	Disabling a CDB Resource Plan	21-37
21.2.9	Viewing Information About Plans and Directives in a CDB	21-38
21.2.9.1	Viewing CDB Resource Plans	21-38
21.2.9.2	Viewing CDB Resource Plan Directives	21-39
21.3	Managing PDB Resource Plans	21-40
21.3.1	About PDB Resource Plans	21-41
21.3.1.1	CDB Resource Plan Requirements When Creating PDB Resource Plans	21-42
21.3.1.2	PDB Resource Plan: Example	21-43
21.3.2	Creating a PDB Resource Plan	21-43
21.3.3	Enabling a PDB Resource Plan	21-44
21.3.4	Modifying a PDB Resource Plan	21-45
21.3.5	Disabling a PDB Resource Plan	21-46
21.4	Monitoring PDBs Managed by Oracle Database Resource Manager	21-46
21.4.1	About Resource Manager Views for PDBs	21-47
21.4.2	Monitoring CPU Usage for PDBs	21-48
21.4.3	Monitoring Parallel Execution for PDBs	21-49
21.4.4	Monitoring the I/O Generated by PDBs	21-50
21.4.5	Monitoring Memory Usage for PDBs	21-51

## 22 Using Oracle Scheduler with a CDB

---

22.1	DBMS_SCHEDULER Invocations in a CDB	22-1
22.2	Job Coordinator and Slave Processes in a CDB	22-2
22.3	Using DBMS_JOB	22-3
22.4	Processes to Close a PDB	22-3
22.5	New and Changed CDB Views	22-3

## 23 Using Oracle Database Vault with a CDB

---

23.1	About Oracle Database Vault	23-2
23.2	How Oracle Database Vault Works in a Multitenant Environment	23-2
23.3	Manually Installing Oracle Database Vault in a Multitenant Environment	23-4
23.4	Verifying That Database Vault Is Configured and Enabled	23-5
23.5	Registering Database Vault in the CDB Root	23-5
23.6	Registering Database Vault Common Users to Manage Specific PDBs	23-8
23.7	Creating Common Database Vault Accounts for a Plugged in Database Vault PDB	23-10
23.8	Realms in a Multitenant Environment	23-11
23.9	Realm Authorizations in a Multitenant Environment	23-12
23.10	Rule Sets and Rules in a Multitenant Environment	23-13

23.11	Command Rules in a Multitenant Environment	23-13
23.12	Oracle Database Vault Policies in a Multitenant Environment	23-14
23.13	Converting a Standalone Oracle Database to a PDB and Plugging It into a CDB	23-14

## 24 Using XStream with a CDB

---

24.1	About XStream	24-1
24.2	System-Created Rules and a Multitenant Environment	24-3
24.2.1	System-Created Rules in a CDB and XStream Out	24-4
24.2.2	System-Created Rules in a CDB and XStream In	24-6
24.3	XStream Out and a Multitenant Environment	24-7
24.4	Configuring XStream Out in a CDB	24-8
24.4.1	Configuring XStream Out with Local Capture in a CDB	24-9
24.4.2	Configuring XStream Out with Downstream Capture in CDBs	24-12
24.5	XStream In and a Multitenant Environment	24-17

## Part VI Administering a Multitenant Environment with Cloud Control

---

### 25 Logging into a Multitenant Environment in Enterprise Manager

---

25.1	Logging into a CDB or a PDB	25-1
25.2	Switching to a Different PDB or to the Root	25-2

### 26 Creating and Removing PDBs with Cloud Control

---

26.1	Getting Started with Creating and Removing PDBs with Cloud Control	26-1
26.2	Overview of Creating and Removing PDBs with Cloud Control	26-2
26.3	Provisioning a PDB with Cloud Control	26-3
26.3.1	Creating a New PDB with Cloud Control	26-4
26.3.1.1	Prerequisites	26-4
26.3.1.2	Procedure	26-4
26.3.2	Plugging In an Unplugged PDB with Cloud Control	26-6
26.3.2.1	Prerequisites	26-7
26.3.2.2	Procedure	26-7
26.3.3	Cloning a PDB with Cloud Control	26-11
26.3.3.1	Prerequisites	26-11
26.3.3.2	Procedure	26-12
26.3.4	Migrating a Non-CDB to a PDB with Cloud Control	26-15
26.3.4.1	Prerequisites	26-15
26.3.4.2	Procedure	26-16

26.4	Removing PDBs with Cloud Control	26-17
26.4.1	Unplugging and Dropping a PDB with Cloud Control	26-17
26.4.1.1	Prerequisites	26-17
26.4.1.2	Procedure	26-17
26.4.2	Deleting PDBs with Cloud Control	26-20
26.4.2.1	Prerequisites	26-20
26.4.2.2	Procedure	26-20
26.5	Viewing PDB Job Details with Cloud Control	26-22
26.5.1	Viewing Create PDB Job Details with Cloud Control	26-22
26.5.2	Viewing Unplug PDB Job Details with Cloud Control	26-23
26.5.3	Viewing Delete PDB Job Details with Cloud Control	26-23

## 27 Administering CDBs and PDBs with Cloud Control

---

27.1	Administering CDB Storage and Schema Objects with Cloud Control	27-1
27.1.1	About Managing and Monitoring CDB Storage and Schema Objects	27-2
27.1.2	Managing CDB Storage and Schema Objects	27-2
27.1.3	Managing Per-Container Storage and Schema Objects	27-3
27.1.4	Monitoring Storage and Schema Alerts	27-3
27.2	Administering PDBs with Cloud Control	27-3
27.2.1	Switching Between PDBs	27-4
27.2.2	Altering the Open Mode of a PDB	27-4

## 28 Using Oracle Resource Manager for PDBs with Cloud Control

---

28.1	About CDB Resource Manager and Cloud Control	28-1
28.2	Creating a CDB Resource Plan with Cloud Control	28-2
28.3	Creating a PDB Resource Plan with Cloud Control	28-2

## 29 Managing Security for a Multitenant Environment in Enterprise Manager

---

29.1	About Managing Security for a Multitenant Environment in Enterprise Manager	29-1
29.2	Managing Common and Local Users in Enterprise Manager	29-1
29.2.1	Creating a Common User Account in Enterprise Manager	29-2
29.2.2	Editing a Common User Account in Enterprise Manager	29-3
29.2.3	Dropping a Common User Account in Enterprise Manager	29-3
29.2.4	Creating a Local User Account in Enterprise Manager	29-4
29.2.5	Editing a Local User Account in Enterprise Manager	29-4
29.2.6	Dropping a Local User Account in Enterprise Manager	29-5
29.3	Managing Common and Local Roles and Privileges in Enterprise Manager	29-5

29.3.1	Creating a Common Role in Enterprise Manager	29-6
29.3.2	Editing a Common Role in Enterprise Manager	29-6
29.3.3	Dropping a Common Role in Enterprise Manager	29-7
29.3.4	Revoking Common Privilege Grants in Enterprise Manager	29-7
29.3.5	Creating a Local Role in Enterprise Manager	29-8
29.3.6	Editing a Local Role in Enterprise Manager	29-8
29.3.7	Dropping a Local Role in Enterprise Manager	29-9
29.3.8	Revoking Local Privilege Grants in Enterprise Manager	29-9

## Glossary

---

## Index

---



# Preface

This document describes how to create, configure, and administer an Oracle database.

- [Audience](#)
- [Documentation Accessibility](#)
- [Related Documents](#)
- [Conventions](#)

## Audience

This document is intended for database administrators who perform the following tasks:

- Create and configure one or more Oracle databases
- Monitor and tune Oracle databases
- Oversee routine maintenance operations for Oracle databases
- Create and maintain schema objects, such as tables, indexes, and views
- Schedule system and user jobs
- Diagnose, repair, and report problems

To use this document, you should be familiar with relational database concepts. You should also be familiar with the operating system environment under which you are running Oracle Database.

## Documentation Accessibility

For information about Oracle's commitment to accessibility, visit the Oracle Accessibility Program website at <http://www.oracle.com/pls/topic/lookup?ctx=acc&id=docacc>.

### **Access to Oracle Support**

Oracle customers that have purchased support have access to electronic support through My Oracle Support. For information, visit <http://www.oracle.com/pls/topic/lookup?ctx=acc&id=info> or visit <http://www.oracle.com/pls/topic/lookup?ctx=acc&id=trs> if you are hearing impaired.

## Related Documents

For more information, see these Oracle resources:

- *Oracle Database Concepts*
- *Oracle Database Administrator's Guide*
- *Oracle Database 2 Day DBA*
- *Oracle Database SQL Language Reference*
- *Oracle Database Reference*
- *Oracle Database PL/SQL Packages and Types Reference*
- *Oracle Automatic Storage Management Administrator's Guide*
- *Oracle Database VLDB and Partitioning Guide*
- *Oracle Database Error Messages Reference*
- *Oracle Database Net Services Administrator's Guide*
- *Oracle Database Backup and Recovery User's Guide*
- *Oracle Database Performance Tuning Guide*
- *Oracle Database SQL Tuning Guide*
- *Oracle Database Development Guide*
- *Oracle Database PL/SQL Packages and Types Reference*
- *SQL\*Plus User's Guide and Reference*

Many of the examples in this book use the sample schemas. See *Oracle Database Sample Schemas* for information about these schemas.

## Conventions

The following text conventions are used in this document:

Convention	Meaning
<b>boldface</b>	Boldface type indicates graphical user interface elements associated with an action, or terms defined in text or the glossary.
<i>italic</i>	Italic type indicates book titles, emphasis, or placeholder variables for which you supply particular values.
monospace	Monospace type indicates commands within a paragraph, URLs, code in examples, text that appears on the screen, or text that you enter.

# Changes in This Release for Oracle Multitenant Administrator's Guide

There are changes in this document for recent releases of Oracle Database.

- [Changes in Oracle Database Release 18c, Version 18.1](#)
- [Changes in Oracle Database 12c Release 2 \(12.2.0.1\)](#)
- [Changes in Oracle Database 12c Release 1 \(12.1.0.2\)](#)
- [Changes in Oracle Database 12c Release 1 \(12.1.0.1\)](#)

## Changes in Oracle Database Release 18c, Version 18.1

The following are changes in *Oracle Multitenant Administrator's Guide* for Oracle Database release 18c, version 18.1.

- [New Features](#)

### New Features

The following features are new in this release:

- CDB fleet

A **CDB fleet** is a collection of different CDBs that can be managed as one logical CDB.

See "[Administering a CDB Fleet](#)".

- PDB snapshot carousel

A **PDB snapshot** is a point-in-time copy of a PDB. You can create snapshots manually using the `SNAPSHOT` clause of `CREATE PLUGGABLE DATABASE` (or `ALTER PLUGGABLE DATABASE`), or automatically using the `EVERY interval` clause. When a PDB is enabled for snapshots, you can create multiple snapshots (point-in-time copies) of the PDB. The library of snapshots is called a PDB snapshot carousel. You can quickly clone a new PDB based on any snapshot in the carousel. In this way, you can perform point-in-time recovery to any snapshot in the carousel, or rapidly create a PDB by cloning any snapshot.

See "[User Interface for PDB Snapshot Carousel](#)" and "[Administering a PDB Snapshot Carousel](#)".

- Logical partitioning

A container map enables a session to issue SQL statements that are routed to the appropriate PDB, depending on the value of a predicate used in the SQL statement. The partitioning column in the map table does not need to match a column in the metadata-linked table. For example, if the table `sales` is enabled for

the container map `pdb_map_tbl`, and if `sales` does not have the column used to partition `pdb_map_tbl`, then queries with the predicate `CONTAINERS(sales)` are still routed to the PDBs specified in the map table.

See "[Container Maps](#)".

- Refreshable PDB switchover

A **refreshable clone PDB** is a read-only clone that can periodically synchronize with its source PDB. You can reverse the roles, transforming the source PDB into the clone and the clone into the source. This technique can be useful for load balancing. Also, if the source PDB fails, then you can resume operations on the clone PDB, rendering a CDB-level Oracle Data Guard failover unnecessary.

See "[About Refreshable Clone PDBs](#)" and "[Switching Over a Refreshable Clone PDB](#)".

- Lockdown profile enhancements

You can create, alter, or drop lockdown profiles in application containers. Also, you can create lockdown profiles based on a static or a dynamic base profile.

See "[Overview of PDB Lockdown Profiles](#)", "[About Restricting PDB Users for Enhanced Security](#)", and "[Restricting Operations on PDBs Using PDB Lockdown Profiles](#)".

- DBCA enhancements

You can use DBCA to clone a local PDB or duplicate a CDB. Duplication is only supported in silent mode.

See "[About CDB Creation with DBCA](#)" and "[About Cloning a Local PDB](#)".

- Usable backups of non-CDBs and relocated PDBs

When you are cloning a non-CDB as a PDB or relocating a PDB, you can use the `DBMS_PDB.EXPORTRMANBACKUP` procedure to export RMAN backup metadata into the PDB dictionary. This metadata enables backups of the source non-CDB or PDB to be usable for restore and recovery of the target PDB.

See "[General Prerequisites for PDB Creation](#)".

- RMAN duplication of a PDB to another CDB

You can clone a PDB from a source CDB to an existing CDB that is open read/write.

See "[Techniques for Creating a PDB](#)".

- Relocation of sessions during planned maintenance

Application Continuity can drain database sessions during planned maintenance when the application submits a connection test, at request boundaries, and at good places to fail over. The relocation is transparent to applications. This feature is on by default for all maintenance operations invoked at the database service and PDB levels: stop service, relocate service, relocate PDB, and stop PDB.

See "[Managing Services for PDBs](#)", "[How PDB Relocation Works](#)", and *Oracle Real Application Clusters Administration and Deployment Guide*.

- Copying a PDB in an Oracle Data Guard environment

When performing a remote clone in a primary database, or plugging in a PDB in a primary database, you can set initialization parameters in a standby database that automates copying the data files for the newly created PDB.

See ["Cloning a Remote PDB: Basic Steps"](#) and ["Plugging In an Unplugged PDB"](#).

- Parallel statement queuing at the PDB level

You can configure parallel statement queuing for a PDB just as for a non-PDB using the `PARALLEL_SERVERS_TARGET` initialization parameter. At the PDB level, the default is based on the `CPU_COUNT` setting for the PDB. At the CDB level, the default value is the value of the `PARALLEL_MAX_SERVERS` initialization parameter.

See ["Utilization Limits for PDBs"](#).

- Split mirror clone PDBs

When a PDB resides in Oracle ASM, you can use a split mirroring technique to clone a PDB. The cloned PDB is independent of the original PDB. The principal use case is to rapidly provision test and development PDBs in an Oracle ASM environment.

See ["About Split Mirror Clone PDBs"](#).

## Changes in Oracle Database 12c Release 2 (12.2.0.1)

The following are changes in the Oracle Multitenant option documentation for Oracle Database 12c Release 2 (12.2.0.1).

- [New Features](#)

### New Features

The following features are new in this release:

- Application containers

An application container is an optional component of a multitenant container database (CDB) that consists of an application root and the application PDBs associated with it. An application container stores data for one or more applications.

See ["Overview of Applications in an Application Container"](#).

- Application common objects

Application common objects are created in an application root and are shared with the application PDBs that belong to the application root.

See ["Managing Application Common Objects"](#).

- Support for thousands of pluggable databases (PDBs) in a single CDB

A CDB can contain up to 4,096 PDBs.

- Use different character sets for PDBs

When the character set of the CDB root is AL32UTF8, any container in the CDB can use a character set that is different from the CDB root and different from other containers in the CDB.

See ["Decide How to Configure the CDB"](#) and *Oracle Database Globalization Support Guide*.

- Relocate a PDB from one CDB to another

A PDB can be relocated in one operation with minimal down time.

- See "[Relocating a PDB](#)".
- Proxy PDB  
A proxy PDB references a PDB in a different CDB and provides fully functional access to the referenced PDB.  
See "[Creating a PDB as a Proxy PDB](#)"
  - Hot PDB cloning  
The source PDB can be in open read/write mode during a PDB clone operation.  
See "[Cloning a PDB or Non-CDB](#)".
  - Rename services during PDB creation  
The `SERVICE_NAME_CONVERT` clause of the `CREATE PLUGGABLE DATABASE` statement renames the user-defined services of the new PDB based on the service names of the source PDB.  
See "[Service Name Conversion](#)".
  - Switch to a specific service for a container in a CDB  
You can specify a service name in an `ALTER SESSION SET CONTAINER` statement.  
See "[Switching to a Container Using the ALTER SESSION Statement](#)".
  - Manage the memory usage of PDBs in a CDB  
You can configure guarantees and limits for SGA and PGA memory, using PDB initialization parameters.  
See "[Memory-Related Initialization Parameters for PDBs](#)."
  - Limit the I/O generated by specific PDBs  
Two new initialization parameters, `MAX_IOPS` and `MAX_MBPS`, enable you to limit disk I/O generated by a PDB. `MAX_IOPS` limits the number of I/O operations, and `MAX_MBPS` limits the megabytes for I/O operations.  
See "[I/O-Related Initialization Parameters for PDBs](#)".
  - PDB performance profiles  
You can specify Resource Manager directives for a set of PDBs using PDB performance profiles.  
See "[Creating New CDB Resource Plan Directives for a PDB Performance Profile](#)".
  - Monitor PDBs managed by Oracle Database Resource Manager  
A set of dynamic performance views enables you to monitor the results of your Oracle Database Resource Manager settings for PDBs.  
See "[Monitoring PDBs Managed by Oracle Database Resource Manager](#)".
  - Prioritize PDB upgrades  
You can prioritize the PDBs in a CDB when you upgrade the CDB. The PDBs with higher priority are upgraded before PDBs with lower priority.  
See *Oracle Database Upgrade Guide*.
  - CDB undo mode

A CDB can run in local undo mode or shared undo mode. Local undo mode means that every container in the CDB uses local undo. Shared undo mode means that there is one active undo tablespace for a single-instance CDB. For an Oracle RAC CDB, there is one active undo tablespace for each instance.

See "[Setting the Undo Mode in a CDB Using ALTER DATABASE](#)".

- Parallelized PDB creation

The `PARALLEL` clause of the `CREATE PLUGGABLE DATABASE` statement specifies whether to use parallel execution servers during PDB creation and, optionally, the degree of parallelism.

- Unplugging PDBs and plugging in PDBs with an archive file

A PDB can be unplugged into compressed archive of the XML file that describes the PDB and the files used by the PDB (such as the data files and wallet file). The archive file has a `.pdb` extension, and it can be used to plug the PDB into a CDB or application container.

"[About Unplugging a PDB](#)" and "[About the XML File and Archive File](#)".

- PDB refresh

You can create a PDB as a refreshable clone and refresh the PDB with changes made to the source PDB.

See "[Refreshing a PDB](#)".

- Improved support for default tablespace specification during PDB creation

You can specify a default tablespace for a PDB that is created using techniques such as cloning and plugging in the PDB. Previously, a default tablespace could be specified only if the PDB was created from `PDB$SEED`.

See "[Default Tablespace](#)".

- Extended `USER_TABLESPACES` clause during PDB creation

The creation mode of user tablespaces can be different than the creation mode of the PDB. For example, during PDB creation, the user tablespaces can move a tablespace's files even when file copy is specified for the PDB.

See "[User Tablespaces](#)".

## Changes in Oracle Database 12c Release 1 (12.1.0.2)

The following are changes in the Oracle Multitenant option documentation for Oracle Database 12c Release 1 (12.1.0.2).

- [New Features](#)

### New Features

The following features are new in this release:

- Preserving the open mode of PDBs when the CDB restarts

You can preserve the open mode of one or more PDBs when the CDB restarts by using the `ALTER PLUGGABLE DATABASE SQL` statement with a `pdb_save_or_discard_state` clause.

See "[Preserving or Discarding the Open Mode of PDBs When the CDB Restarts](#)".

- The `USER_TABLESPACES` clause of the `CREATE PLUGGABLE DATABASE` statement  
 You can use this clause to separate the data for multiple schemas into different PDBs. For example, assume that each schema in a non-CDB uses a separate tablespace. When you move a non-CDB to a PDB, and when the non-CDB has schemas that supported different applications, you can use this clause to separate the data belonging to each schema into a separate PDB,  
 See "[User Tablespaces](#)".
- Excluding data when cloning a PDB  
 The `NO DATA` clause of the `CREATE PLUGGABLE DATABASE` statement specifies that a PDB's data model definition is cloned but not the PDB's data.
- Default Oracle Managed Files file system directory or Oracle ASM disk group for a PDB's files  
 The `CREATE_FILE_DEST` clause specifies the default location.  
 See "[PDB File Locations](#)".
- Create a PDB by cloning a non-CDB  
 You can create a PDB by cloning a non-CDB with a `CREATE PLUGGABLE DATABASE` statement that includes the `FROM` clause.  
 See "[Cloning a PDB or Non-CDB](#)".
- The *logging\_clause* of the `CREATE PLUGGABLE DATABASE` and `ALTER PLUGGABLE DATABASE` statement  
 This clause specifies the logging attribute of the PDB. The logging attribute controls whether certain DML operations are logged in the redo log file (`LOGGING`) or not (`NOLOGGING`).  
 See "[Modifying a PDB at the Database Level](#)" for information about this clause and the `ALTER PLUGGABLE DATABASE` statement.
- The *pdb\_force\_logging\_clause* of the `ALTER PLUGGABLE DATABASE` statement  
 This clause places a PDB into force logging or force nologging mode or takes a PDB out of force logging or force nologging mode.  
 See "[Modifying a PDB at the Database Level](#)".
- The `STANDBYS` clause of the `CREATE PLUGGABLE DATABASE` statement  
 This clause specifies whether the new PDB is included in standby CDBs.  
 See *Oracle Data Guard Concepts and Administration* for more information about configuring PDBs on standby CDBs.
- Querying user-created tables and views across all PDBs  
 The `CONTAINERS` clause enables you to query user-created tables and views across all PDBs in a CDB.  
 See [Querying User-Created Tables and Views Across All Containers](#).

## Changes in Oracle Database 12c Release 1 (12.1.0.1)

The following are changes in the Oracle Multitenant option documentation for Oracle Database 12c Release 1 (12.1.0.1).



- [New Features](#)

## New Features

The following features are new in this release:

- Oracle Multitenant option

Oracle Multitenant option enables an Oracle database to function as a multitenant container database (CDB) that includes one or many customer-created pluggable databases (PDBs). A PDB is a portable collection of schemas, schema objects, and nonschema objects that appears to an Oracle Net client as a non-CDB. All Oracle databases before Oracle Database 12c were non-CDBs. You can unplug a PDB from a CDB and plug it into a different CDB.

See "[Administering a Multitenant Environment](#)".

- Resource Manager support for a multitenant environment

Resource Manager can manage resources on the CDB level and on the PDB level. You can create a CDB resource plan that allocates resources to the entire CDB and to individual PDBs. You can allocate more resources to some PDBs and less to others, or you can specify that all PDBs share resources equally.

See "[Using Oracle Resource Manager for PDBs](#)".

# Part I

## Multitenant Architecture

The **multitenant architecture** enables an Oracle database to function as a multitenant container database (CDB).

This part contains the following topics:

- [Introduction to the Multitenant Architecture](#)  
Become familiar with the **Oracle Multitenant** option.
- [Overview of the Multitenant Architecture](#)  
This chapter describes the most important components of the multitenant architecture.

# 1

## Introduction to the Multitenant Architecture

Become familiar with the **Oracle Multitenant** option.

This chapter contains the following topics:

- [About the Multitenant Architecture](#)  
The **multitenant architecture** enables an Oracle database to function as a multitenant container database (CDB).
- [Benefits of the Multitenant Architecture](#)  
The multitenant architecture solves several problems posed by the traditional non-CDB architecture.
- [Path to Database Consolidation](#)  
For the duration of its existence, a database is either a CDB or a non-CDB.
- [Multitenant Environment Documentation Roadmap](#)  
This topic lists the most important topics for understanding and using CDBs, and includes cross-references to the appropriate documentation.

### 1.1 About the Multitenant Architecture

The **multitenant architecture** enables an Oracle database to function as a multitenant container database (CDB).

A **CDB** includes zero, one, or many customer-created pluggable databases (PDBs). A **PDB** is a portable collection of schemas, schema objects, and nonschema objects that appears to an Oracle Net client as a **non-CDB**. All Oracle databases before Oracle Database 12c were non-CDBs.



This section contains the following topics:

- [About Containers in a CDB](#)  
A **container** is logical collection of data or metadata within the multitenant architecture.
- [About User Interfaces for the Multitenant Architecture](#)  
You can use the same administration tools for both CDBs and non-CDBs.

#### 1.1.1 About Containers in a CDB

A **container** is logical collection of data or metadata within the multitenant architecture.

The following figure represents possible containers in a CDB.

Figure 1-1 Containers in a CDB

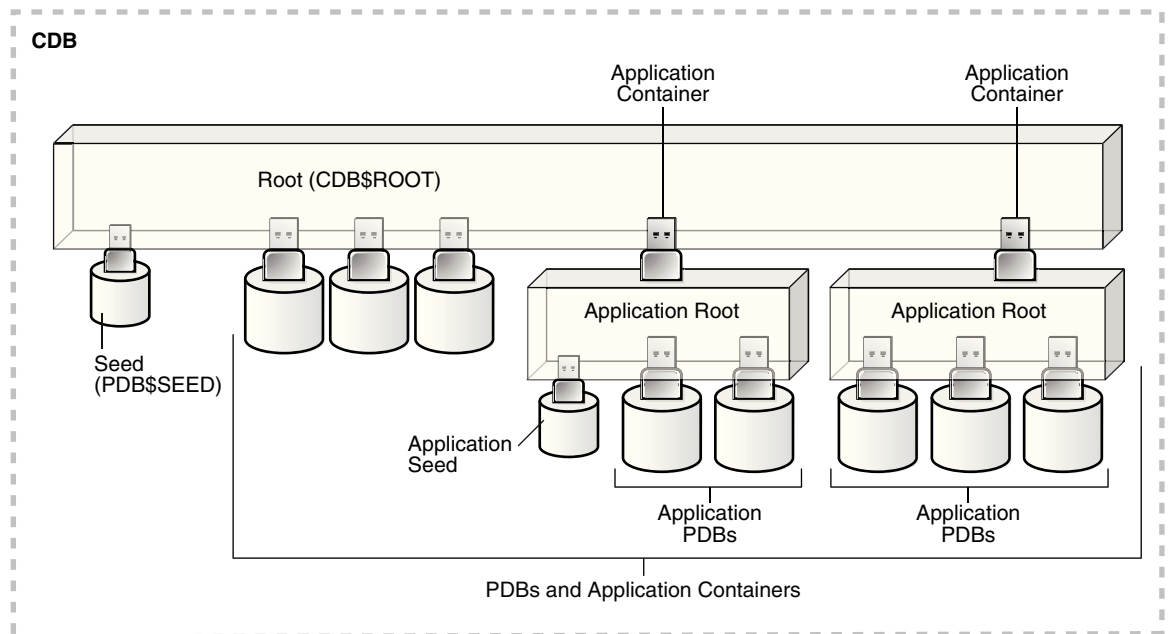

Every CDB has the following containers:

- Exactly one CDB root container (also called simply *the root*)  
The **CDB root** is a collection of schemas, schema objects, and nonschema objects to which all PDBs belong (see "[Overview of Containers in a CDB](#)"). The root stores Oracle-supplied metadata and common users. An example of metadata is the source code for Oracle-supplied PL/SQL packages (see "[Data Dictionary Architecture in a CDB](#)"). A common user is a database user known in every container (see "[Common Users in a CDB](#)"). The root container is named `CDB$ROOT`.
- Exactly one system container  
The **system container** includes the root CDB and all PDBs in the CDB. Thus, the system container is the logical container for the CDB itself.
- Zero or more application containers  
An **application container** consists of exactly one **application root**, and the PDBs plugged in to this root. Whereas the system container contains the CDB root and *all* the PDBs within the CDB, an application container includes only the PDBs plugged into the application root. An application root belongs to the CDB root and no other container.
- Zero or more user-created PDBs  
A PDB contains the data and code required for a specific set of features (see "[PDBs](#)"). For example, a PDB can support a specific application, such as a human resources or sales application. No PDBs exist at creation of the CDB. You add PDBs based on your business requirements.  
  
A PDB belongs to exactly zero or one application container. If a PDB belongs to an application container, then it is an **application PDB**. For example, the `cust1_pdb` and `cust2_pdb` application PDBs might belong to the `saas_sales_ac` application container, in which case they belong to no other application containers.

An **application seed** is an optional application PDB that acts as a user-created PDB template, enabling you to create new application PDBs rapidly.

- Exactly one **seed PDB**

The seed PDB is a system-supplied template that the CDB can use to create new PDBs. The seed PDB is named `PDB$SEED`. You cannot add or modify objects in `PDB$SEED`.

### Example 1-1 CDB with No Application Containers

This example shows a simple CDB with five containers: the system container (the entire CDB), the CDB root, the PDB seed (`PDB$SEED`), and two PDBs. Each PDB has its own dedicated application. A different PDB administrator manages each PDB. A **common user** exists across a CDB with a single identity. In this example, common user `sys` can manage the root and every PDB. At the physical level, this CDB has a database instance and database files, just as a non-CDB does.

Figure 1-2 CDB with No Application Containers

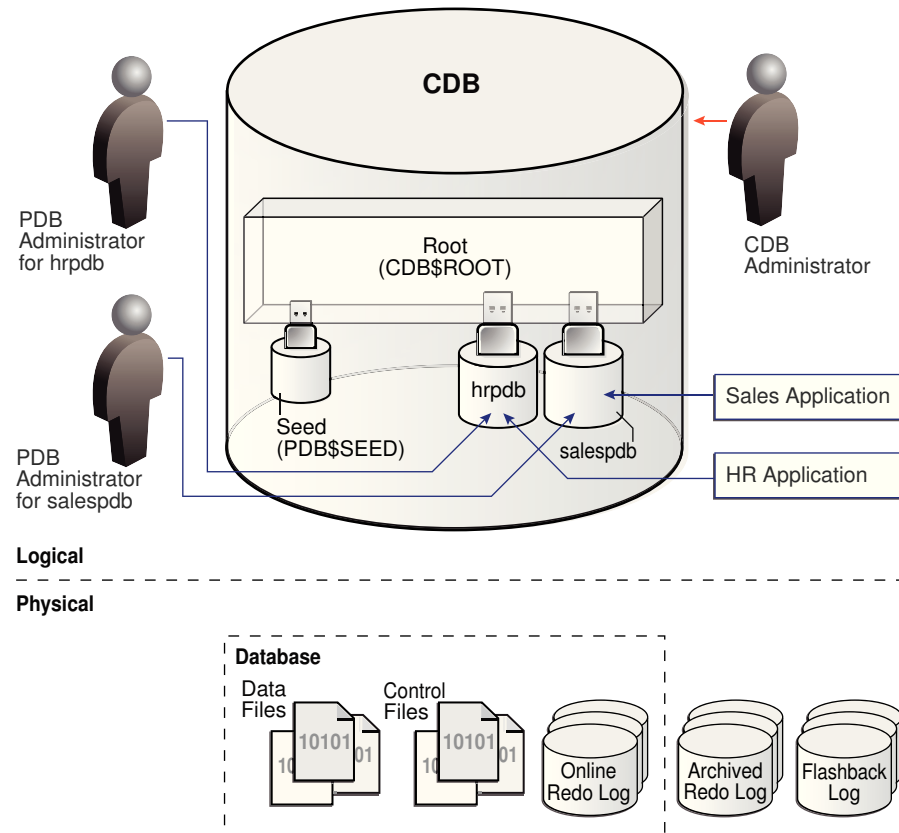

### Example 1-2 CDB with an Application Container

In this variation, the CDB contains an application container named `saas_sales_ac`. Within the application container, the application PDB `cust1_pdb` supports an application for one customer, and the application PDB `cust2_pdb` supports an application for a different customer. The CDB also contains a PDB named `hrpdb`, which supports an HR application, but does not belong to an application container.

Figure 1-3 CDB with an Application Container

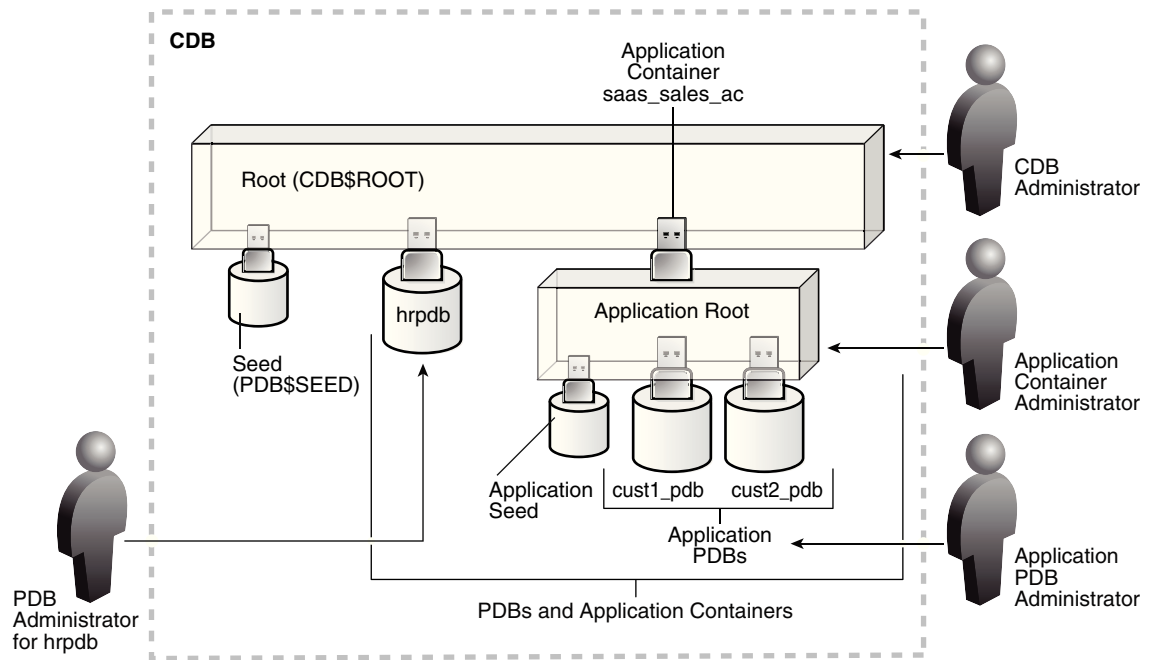

In this example, multiple DBAs manage the CDB environment:

- A CDB administrator manages the CDB itself.
- An application container administrator manages the `saas_sales_ac` container, including application installation and upgrades.
- An application PDB administrator manages the two PDBs in the `saas_sales_ac` container: `cust1_pdb` and `cust2_pdb`.
- A PDB administrator manages `hrpdb`.

 **See Also:**

[" Overview of Configuring and Managing a Multitenant Environment"](#)

## 1.1.2 About User Interfaces for the Multitenant Architecture

You can use the same administration tools for both CDBs and non-CDBs.

Table 1-1 Tools in a Multitenant Environment

Interface	Description	See Also
SQL*Plus and SQL Developer for command-line access	SQL*Plus is an interactive and batch query tool that is installed with Oracle Database.	<i>SQL*Plus User's Guide and Reference</i>

**Table 1-1 (Cont.) Tools in a Multitenant Environment**

Interface	Description	See Also
Oracle Enterprise Manager Cloud Control (Cloud Control)	Cloud Control is an Oracle Database administration tool that provides a graphical user interface (GUI). Cloud Control supports Oracle Database 12c targets, including PDBs, CDBs, and non-CDBs.	" <a href="#">Administering CDBs and PDBs with Cloud Control</a> "
Oracle Enterprise Manager Database Express (EM Express)	EM Express is a web-based management product built into the Oracle database. EM Express enables you to provision and manage PDBs, including the following operations: <ul style="list-style-type: none"> <li>• Creating and dropping PDBs</li> <li>• Plugging in and unplugging and PDBs</li> <li>• Cloning PDBs</li> <li>• Setting resource limits for PDBs</li> </ul>	<i>Oracle Database Performance Tuning Guide</i> to learn more about using EM Express for managing CDBs and PDBs
Oracle Database Configuration Assistant (DBCA)	DBCA enables you to create and duplicate CDBs, and create, clone, plug in, and unplug PDBs.	<i>Oracle Database Performance Tuning Guide</i> and <i>Oracle Database Administrator's Guide</i> for more information about DBCA

 **See Also:**

*Oracle Database Concepts* for more information about tools for database administrators

## 1.2 Benefits of the Multitenant Architecture

The multitenant architecture solves several problems posed by the traditional non-CDB architecture.

This section contains the following topics:

- [Challenges for a Non-CDB Architecture](#)  
Large enterprises may use hundreds or thousands of databases. Often these databases run on different platforms on multiple physical servers.
- [Benefits of the Multitenant Architecture for Database Consolidation](#)  
**Database consolidation** is the process of consolidating data from multiple databases into one database on one computer. The Oracle Multitenant option

enables you to consolidate data and code *without altering existing schemas or applications*.

- **Benefits of the Multitenant Architecture for Manageability**  
The multitenant architecture has benefits beyond database consolidation. These benefits derive from storing the data *and* metadata specific to a PDB in the PDB itself rather than storing all dictionary metadata in one place.

## 1.2.1 Challenges for a Non-CDB Architecture

Large enterprises may use hundreds or thousands of databases. Often these databases run on different platforms on multiple physical servers.

Because of improvements in hardware technology, especially the increase in the number of CPUs, servers can handle heavier workloads than before. A database may use only a fraction of the server hardware capacity. This approach wastes both hardware and human resources.

For example, 100 servers may have one database each, with each database using 10% of hardware resources and 10% of an administrator's time. A team of DBAs must manage the SGA, database files, accounts, security, and so on of each database separately, while system administrators must maintain 100 different computers.

To show the problem in reduced scale, [Figure 1-4](#) depicts 11 databases, each with its own application and server. A head DBA oversees a team of four DBAs, each of whom is responsible for two or three databases.

**Figure 1-4 Database Environment Before Database Consolidation**

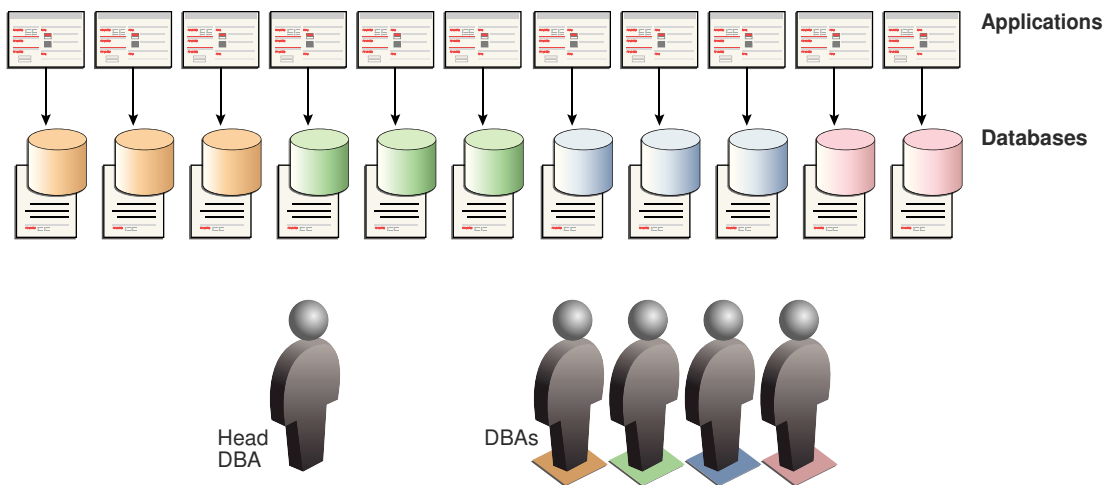

Typical responses include:

- Use virtual machines (VMs).  
In this model, you replicate the operating infrastructure of the physical server—operating system and database—in a virtual machine. VMs are agile, but use technical resources inefficiently, and require individual management. Virtual sprawl, which is just as expensive to manage, replaces the existing physical sprawl.



- Place multiple databases on each server.  
Separate databases eliminate operating system replication, but do not share background processes, system and process memory, or Oracle metadata. The databases require individual management.
- Separate the data logically into schemas or virtual private databases (VPDs).  
This technique uses technical resources efficiently. You can manage multiple schemas or VPDs as one. However, this model is less agile than its alternatives, requiring more effort to manage, secure, and transport. Also, the logical model typically requires extensive application changes, which discourages adoption.

## 1.2.2 Benefits of the Multitenant Architecture for Database Consolidation

**Database consolidation** is the process of consolidating data from multiple databases into one database on one computer. The Oracle Multitenant option enables you to consolidate data and code *without altering existing schemas or applications*.

The [PDB/non-CDB compatibility guarantee](#) means that a PDB behaves the same as a non-CDB as seen from a client connecting with Oracle Net. The installation scheme for an application definition (for example, tables and PL/SQL packages) that runs against a non-CDB runs the same against a PDB and produces the same result. Also, the run-time behavior of client code that connects to the PDB containing the application definition is identical to the behavior of client code that connected to the non-CDB containing this application definition.

Operations that act on an entire non-CDB act in the same way on an entire CDB, for example, when using Oracle Data Guard and database backup and recovery. Thus, the users, administrators, and developers of a non-CDB have substantially the same experience after the database has been consolidated.

The following graphic depicts the databases in [Figure 1-4](#) after consolidation onto one computer. The DBA team is reduced from five to three, with one CDB administrator managing the CDB while two PDB administrators split management of the PDBs.

Figure 1-5 Single CDB

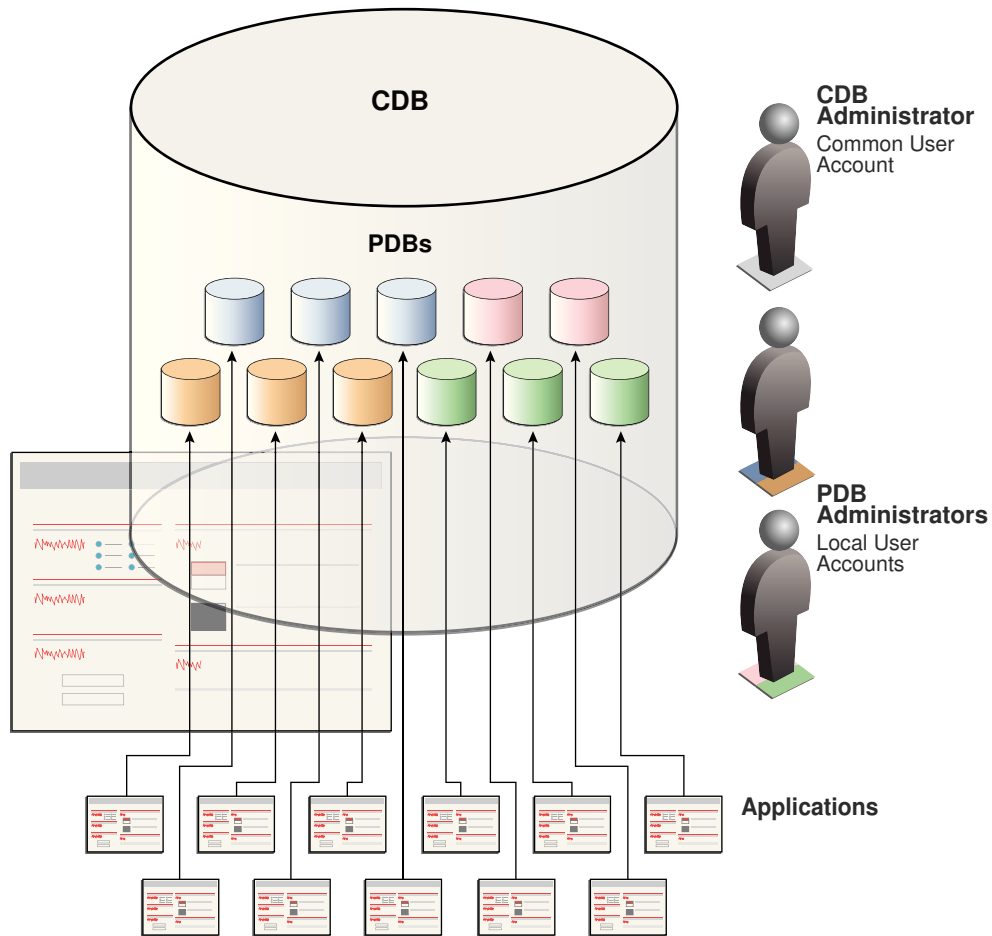

Starting in Oracle Database 12c Release 2 (12.2), you can create an application container that contains application PDBs. This approach enables you to create and manage an application within this container. Most benefits that apply to consolidation into a CDB also apply to consolidation within an application container.

Using the multitenant architecture for database consolidation has the following benefits:

- **Cost reduction**  
By consolidating hardware and database infrastructure to a single set of background processes, and efficiently sharing computational and memory resources, you reduce costs for hardware and maintenance. For example, 100 PDBs on a single server share one database instance.
- **Easier and more rapid movement of data and code**  
By design, you can quickly plug a PDB into a CDB, unplug the PDB from the CDB, and then plug this PDB into a different CDB. You can also clone PDBs while they remain available. You can plug in a PDB with any character set and access it without character set conversion. If the character set of the CDB is AL32UTF8, then PDBs with different database character sets can exist in the same CDB.
- **Easier management and monitoring of the physical database**

The [CDB administrator](#) can manage the environment as an aggregate by executing a single operation, such as patching or performing an RMAN backup, for all hosted tenants and the CDB root. Backup strategies and disaster recovery are simplified.

- Separation of data and code

Although consolidated into a single physical database, PDBs mimic the behavior of non-CDBs. For example, if user error loses critical data, then a PDB administrator can use Oracle Flashback or point-in-time recovery to retrieve the lost data without affecting other PDBs.

- Secure separation of administrative duties

A [common user](#) can connect to any container on which it has sufficient privileges, whereas a [local user](#) is restricted to a specific PDB. Administrators can divide duties as follows:

- An administrator uses a common account to manage a CDB or application container. Because a privilege is contained within the container in which it is granted, a local user on one PDB does not have privileges on other PDBs within the same CDB.
- An administrator uses a local account to manage an individual PDB.

- Ease of performance tuning

It is easier to collect performance metrics for a single database than for multiple databases. It is easier to size one SGA than 100 SGAs.

- Fewer database patches and upgrades

It is easier to apply a patch to one database than to 100 databases, and to upgrade one database than to upgrade 100 databases.

#### See Also:

- "[Overview of Configuring and Managing a Multitenant Environment](#)"
- *Oracle Database Security Guide* to learn about common users

## 1.2.3 Benefits of the Multitenant Architecture for Manageability

The multitenant architecture has benefits beyond database consolidation. These benefits derive from storing the data *and* metadata specific to a PDB in the PDB itself rather than storing all dictionary metadata in one place.

By storing its own dictionary metadata, a PDB becomes easier to manage as a distinct unit. This benefit occurs even when only one PDB resides in a CDB. Grouping PDBs into a separately managed application container increases manageability even further.

In a CDB, the data dictionary metadata is split between the root and the PDBs. Benefits of data dictionary separation include the following:

- Easier upgrade of data and code

For example, instead of upgrading a CDB from one database release to another, you can rapidly unplug a PDB from the existing CDB, and then plug it into a newly created CDB from a higher release.

- Easier migration between servers

To perform load balancing or to meet SLAs, you can migrate an application database from an on-premise data center to the cloud, or between two servers in the same environment.

- Protection against data corruption within a PDB

You can flash back a PDB to an SCN or PDB-specific restore point, without affecting other PDBs. This feature is analogous to the Flashback Database feature for a non-CDB.

- Ability to install, administer, and upgrade application-specific data and metadata in a single place

You can define a set of application-specific PDBs as a single component, called an [application container](#). You can then define one or more applications within this container. Each application is a named, versioned set of common metadata and data shared within this application container.

For example, each customer of a SaaS vendor could have its own [application PDB](#). Each application PDB might have identically defined tables named `sales_mlt`, with different data in each PDB. The PDBs could share a [data-linked common object](#) named `countries_olt`, which has identical data in each PDB. As an application administrator, you could manage the master application definition so that every new customer gets a PDB with the same objects, and every change to existing schemas (for example, the addition of a new table, or a change in the definition of a table) applies to all PDBs that share the application definition.

- Integration with Oracle Database Resource Manager

In a multitenant environment, one concern is contention for system resources among the PDBs running on the same server. Another concern is limiting resource usage for more consistent, predictable performance. To address such resource contention, usage, and monitoring issues, use Oracle Database Resource Manager.



#### See Also:

- ["Overview of Oracle Resource Manager in a CDB"](#)
- ["Data Dictionary Architecture in a CDB"](#)
- ["Administering Application Containers"](#)

## 1.3 Path to Database Consolidation

For the duration of its existence, a database is either a CDB or a non-CDB.

You must define a database as a CDB at creation, and then create PDBs and application containers within this CDB. You cannot later transform a non-CDB into a CDB, or a CDB into a non-CDB.

This section contains the following topics:

- [Creation of a CDB](#)  
The `CREATE DATABASE ... ENABLE PLUGGABLE DATABASE` SQL statement creates a new CDB.
- [Creation of a PDB](#)  
The `CREATE PLUGGABLE DATABASE` SQL statement creates a PDB.

### 1.3.1 Creation of a CDB

The `CREATE DATABASE ... ENABLE PLUGGABLE DATABASE` SQL statement creates a new CDB.

If you do not specify the `ENABLE PLUGGABLE DATABASE` clause, then the newly created database is a non-CDB. In this case, the non-CDB can never contain PDBs.

When you create a CDB, Oracle Database automatically creates a root container (`CDB$ROOT`) and a seed PDB (`PDB$SEED`). The following graphic shows a newly created CDB:

**Figure 1-6 CDB with Seed PDB**

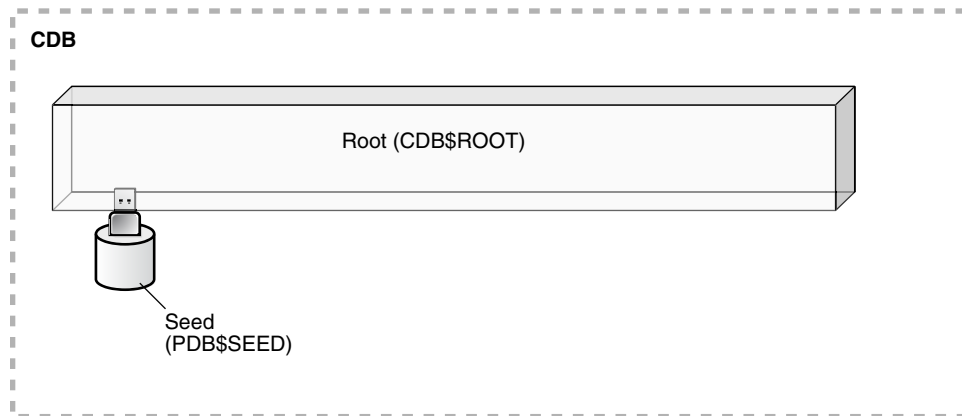

#### Example 1-3 Determining Whether a Database Is a CDB

The following simple query determines whether the database to which an administrative user is currently connected is a non-CDB, or a container in a CDB:

```
SQL> SELECT NAME, CDB, CON_ID FROM V$DATABASE;
```

NAME	CDB	CON_ID
CDB1	YES	0

 **See Also:**

- ["Creating and Configuring a CDB"](#)
- *Oracle Database SQL Language Reference* for more information about specifying the clauses and parameter values for the `CREATE DATABASE` statement

## 1.3.2 Creation of a PDB

The `CREATE PLUGGABLE DATABASE` SQL statement creates a PDB.

The created PDB automatically includes a full data dictionary including metadata and internal links to system-supplied objects in the CDB root. You must define every PDB from a single root: either the [CDB root](#) or an [application root](#).

Each PDB has a globally unique identifier (GUID). The PDB GUID is primarily used to generate names for directories that store the PDB's files, including both Oracle Managed Files directories and non-Oracle Managed Files directories.

This section contains the following topics:

- [Creation of a PDB by Cloning](#)  
One technique for creating a PDB is called *cloning*.
- [Creation of a PDB by Plugging In](#)  
You can create a PDB by plugging in an unplugged PDB, or plugging in a non-CDB as a PDB.
- [Creation of a PDB by Relocating](#)  
To relocate a PDB from one CDB to another, use the `CREATE PLUGGABLE DATABASE` statement with the `FROM` clause and `RELOCATE` keyword.
- [Creation of a PDB as a Proxy PDB](#)  
A **proxy PDB** provides access to different PDB, called the **referenced PDB**, in a remote CDB.

 **See Also:**

["Creating and Removing PDBs and Application Containers"](#)

### 1.3.2.1 Creation of a PDB by Cloning

One technique for creating a PDB is called *cloning*.

You can clone a PDB from `PDB$SEED`, an application seed, a remote or local PDB, or a non-CDB. This section contains the following topics:

- [Creation of a PDB from a Seed](#)  
You can use the `CREATE PLUGGABLE DATABASE` statement to create a PDB from a seed.

- **Creation of a PDB by Cloning a PDB or a Non-CDB**

To clone a PDB or non-CDB, use the `CREATE PLUGGABLE DATABASE` statement with the `FROM` clause.

### 1.3.2.1.1 Creation of a PDB from a Seed

You can use the `CREATE PLUGGABLE DATABASE` statement to create a PDB from a seed.

A seed is a PDB that serves as a template for creation of another PDB. Creating a PDB from a seed copies some or all of the contents of a PDB, and then assigns a new unique identifier.

A seed PDB is either of the following:

- The PDB seed (`PDB$SEED`), which is a system-supplied template for creating PDBs. Every CDB has exactly one `PDB$SEED`, which cannot be modified or dropped.
- An **application seed**, which is a user-created PDB for a specified **application root**.

Within an **application container**, you can create an application seed using the `CREATE PLUGGABLE DATABASE AS SEED` statement, which you can then use to accelerate creation of new application PDBs.

**Figure 1-7 Creation from PDB\$SEED**

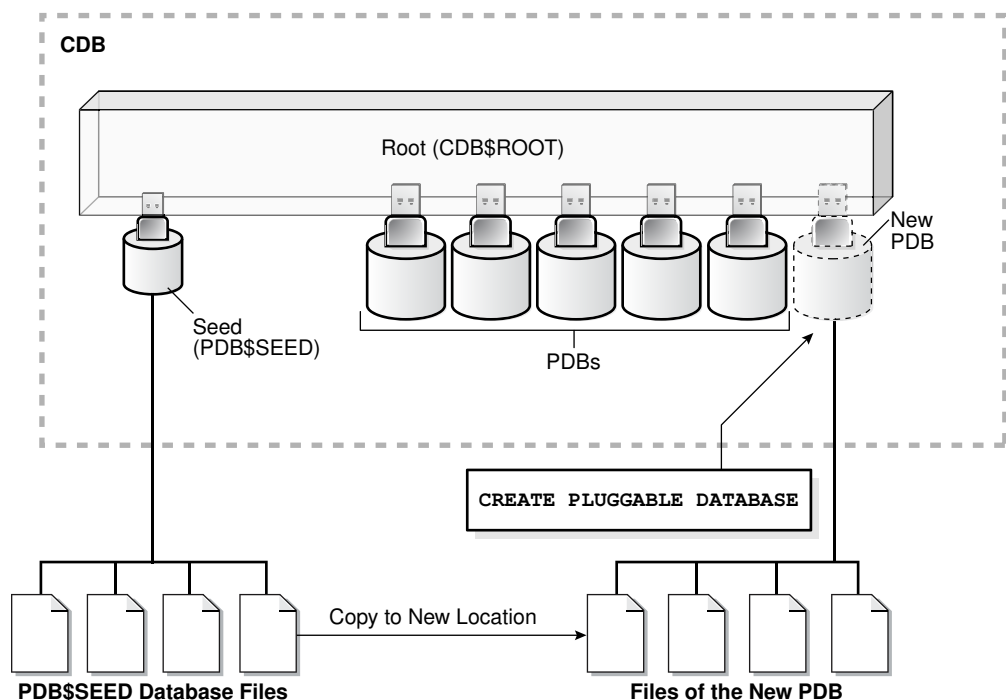

#### Example 1-4 Creation of a PDB from PDB\$SEED

The following SQL statement creates a PDB named `hrpdb` from `PDB$SEED` using Oracle Managed Files:

```
CREATE PLUGGABLE DATABASE hrpdb
  ADMIN USER dbal IDENTIFIED BY password;
```



**See Also:**

["Creating a PDB from Scratch"](#)

### 1.3.2.1.2 Creation of a PDB by Cloning a PDB or a Non-CDB

To clone a PDB or non-CDB, use the `CREATE PLUGGABLE DATABASE` statement with the `FROM` clause.

In this technique, the source is either a non-CDB, or a PDB in a local or remote CDB. The target is the PDB copied from the source. The cloning operation copies the files associated with the source to a new location, and then assigns a new GUID to create the PDB.

This technique is useful for quickly creating PDBs for testing and development. For example, you might test a new or modified application on a cloned PDB before deploying the application in a production PDB. If a PDB is in [local undo mode](#), then the source PDB can be open in read/write mode during the operation, referred to as [hot cloning](#).



**Note:**

If you clone a PDB from a remote CDB, then you must use a database link.

If you run `CREATE PLUGGABLE DATABASE` statement in an application root, then the cloned PDB is created in the application container. In this case, the application name and version of the source PDB must be compatible with the application name and version of the application container.

The following graphic illustrates cloning a PDB when both source and target are in the same CDB.

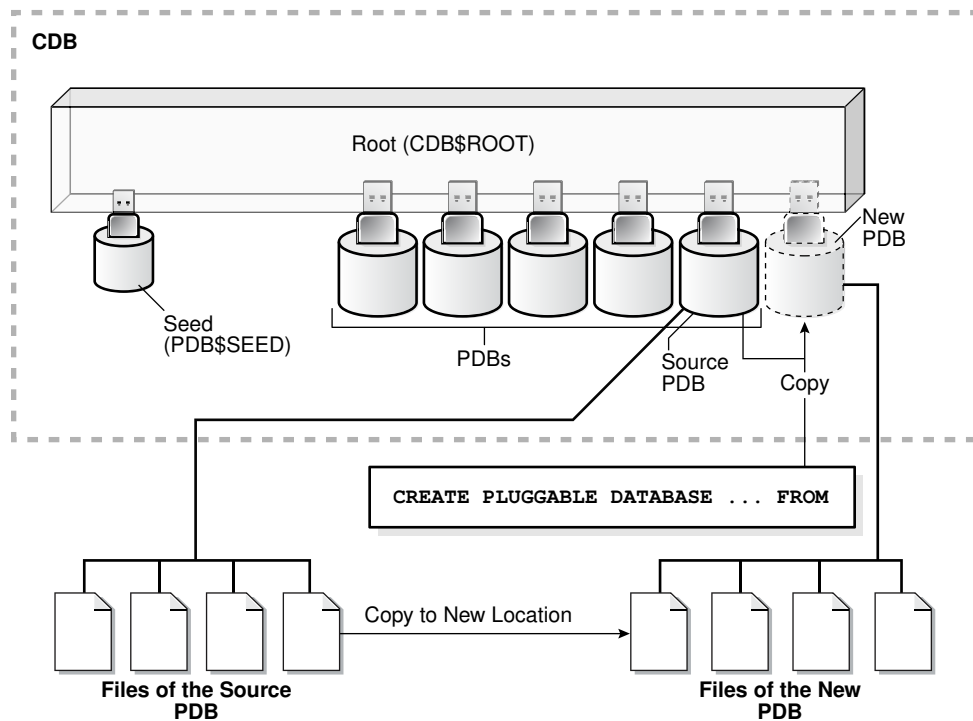

Figure 1-8 Cloning a PDB

**Example 1-5 Cloning a PDB**

The following SQL statement clones a PDB named `salespdb` from the plugged-in PDB named `hrpdb`:

```
CREATE PLUGGABLE DATABASE salespdb FROM hrpdb;
```

This section contains the following topics:

- [Snapshot Copy PDBs](#)  
A **snapshot copy PDB** is a PDB based on a storage-managed (not database-managed) snapshot. The PDB does not contain a complete copy of the source data files.
- [Refreshable Clone PDBs](#)  
A **refreshable clone PDB** is a read-only clone that can periodically synchronize with its source PDB.

 **See Also:**

- ["Cloning a PDB or Non-CDB"](#)
- ["Overview of Tablespaces and Database Files in a CDB"](#)
- ["Application Maintenance"](#)

### 1.3.2.1.2.1 Snapshot Copy PDBs

A **snapshot copy PDB** is a PDB based on a storage-managed (not database-managed) snapshot. The PDB does not contain a complete copy of the source data files.

If the file system supports storage snapshots, then you can clone a PDB almost instantaneously by specifying the `SNAPSHOT COPY` clause. In this case, Oracle Database creates a storage-managed snapshot of the underlying file system, and then uses the storage snapshot to create PDB clones. The snapshot copy PDB contains sparse files.

Unlike a standard clone PDB, a snapshot copy PDB cannot be unplugged from the CDB root or application root. Also, if snapshot clones exist, then the source PDB that generated the clones cannot be dropped or unplugged.

**Note:**

"[About Cloning a PDB](#)" to learn how to clone a PDB using the `SNAPSHOT COPY` clause

### 1.3.2.1.2.2 Refreshable Clone PDBs

A **refreshable clone PDB** is a read-only clone that can periodically synchronize with its source PDB.

Depending on the value specified in the `REFRESH MODE` clause, synchronization occurs automatically or manually. For example, if `hrpdb_re_clone` is a clone of `hrpdb`, then every month you could manually refresh `hrpdb_re_clone` with changes from `hrpdb`. Alternatively, you could configure `hrpdb` to propagate changes to `hrpdb_re_clone` automatically every 24 hours.

You can switch the roles of a source PDB and its refreshable clone. This switchover can be useful for load balancing between CDBs, and when the source PDB suffers a failure.

**Note:**

"[About Cloning a PDB](#)" to learn how to clone a PDB using the `REFRESH MODE` clause

## 1.3.2.2 Creation of a PDB by Plugging In

You can create a PDB by plugging in an unplugged PDB, or plugging in a non-CDB as a PDB.

This section contains the following topics:

- [Creation of a PDB by Plugging In an Unplugged PDB](#)  
An **unplugged PDB** is a self-contained set of data files, and an XML metadata file that specifies the locations of the PDB files. To plug in an unplugged PDB, use the `CREATE PLUGGABLE DATABASE` statement with the `USING` clause.
- [Creation of a PDB from a Non-CDB](#)  
You can move a non-CDB into a PDB.

#### 1.3.2.2.1 Creation of a PDB by Plugging In an Unplugged PDB

An **unplugged PDB** is a self-contained set of data files, and an XML metadata file that specifies the locations of the PDB files. To plug in an unplugged PDB, use the `CREATE PLUGGABLE DATABASE` statement with the `USING` clause.

When plugging in an unplugged PDB, you have the following options:

- Specify the XML metadata file that describes the PDB and the files associated with the PDB.
- Specify a [PDB archive file](#), which is a compressed file that contains both the XML file and PDB data files. You can create a PDB by specifying the archive file, and thereby avoid copying the XML file and the data files separately.

The following graphic illustrates plugging in an unplugged PDB using the XML file.

Figure 1-9 Plugging In an Unplugged PDB

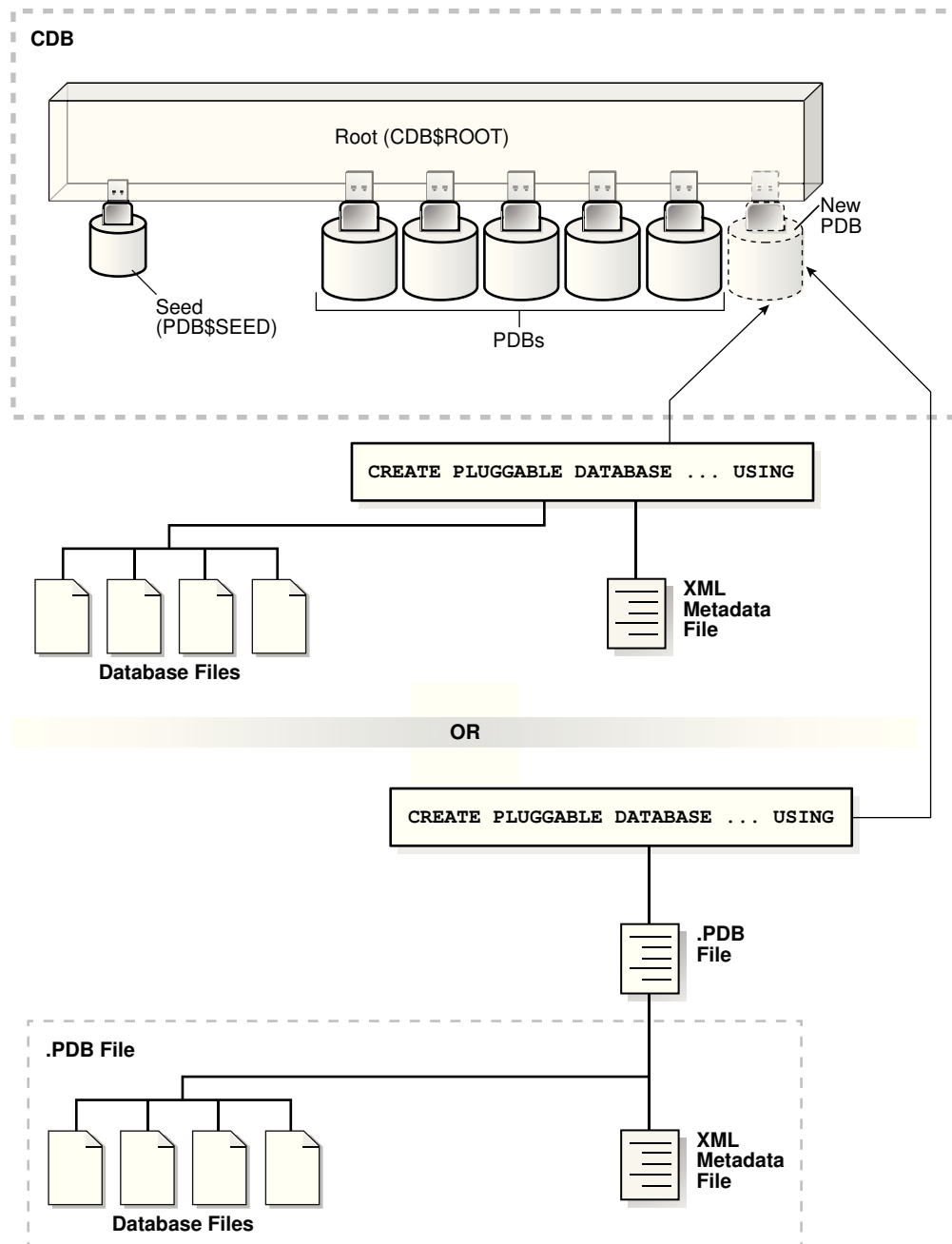

**Example 1-6 Plugging In a PDB**

The following SQL statement plugs in a PDB named `salespdb` based on the metadata stored in the named XML file, and specifies `NOCOPY` because the files of the unplugged PDB do not need to be moved to a new location:

```
CREATE PLUGGABLE DATABASE salespdb USING '/disk1/usr/salespdb.xml' NOCOPY;
```

**See Also:**

"Plugging In an Unplugged PDB"

### 1.3.2.2.2 Creation of a PDB from a Non-CDB

You can move a non-CDB into a PDB.

You can accomplish this task in the following ways:

- Executing `DBMS_PDB.DESCRIBE` on a non-CDB in Oracle Database 12c  
You place a non-CDB in a transactionally consistent state, and then run the `DBMS_PDB.DESCRIBE` function to generate XML metadata about this database. While connected to the root in the CDB, you execute the `CREATE PLUGGABLE DATABASE` statement to create a PDB from the existing non-CDB. Finally, to convert the definitions in the PDB data dictionary to references to objects in `CDB$ROOT`, log in to the PDB and run the `noncdb_to_pdb.sql` script.
- Using Oracle Data Pump with or without transportable tablespaces  
You can define a data set on a non-CDB using Oracle Data Pump. This non-CDB can be in the current or a previous Oracle Database release, for example, Oracle Database 10g. You create an empty PDB in an existing CDB, and then use Oracle Data Pump to import the data set into the PDB.  
A Full Transportable Export using Oracle Data Pump exports all objects and data necessary to create a complete copy of the database. Oracle Data Pump exports objects using direct path unload and external tables, and then imports objects using direct path `INSERT` and external tables. The Full Transportable dump file contains all objects in the database, not only table-related objects. Full Transportable Export is available starting in Oracle Database 11g Release 2 (11.2.0.3) for import into Oracle Database 12c and later.
- Using Oracle GoldenGate replication  
You replicate the data from the non-CDB to a PDB. When the PDB becomes current with the non-CDB, you switch over to the PDB.

The following figure illustrates running the `DBMS_PDB.DESCRIBE` function on a non-CDB, and then creating a PDB using the non-CDB files.

Figure 1-10 Creating a PDB from a Non-CDB

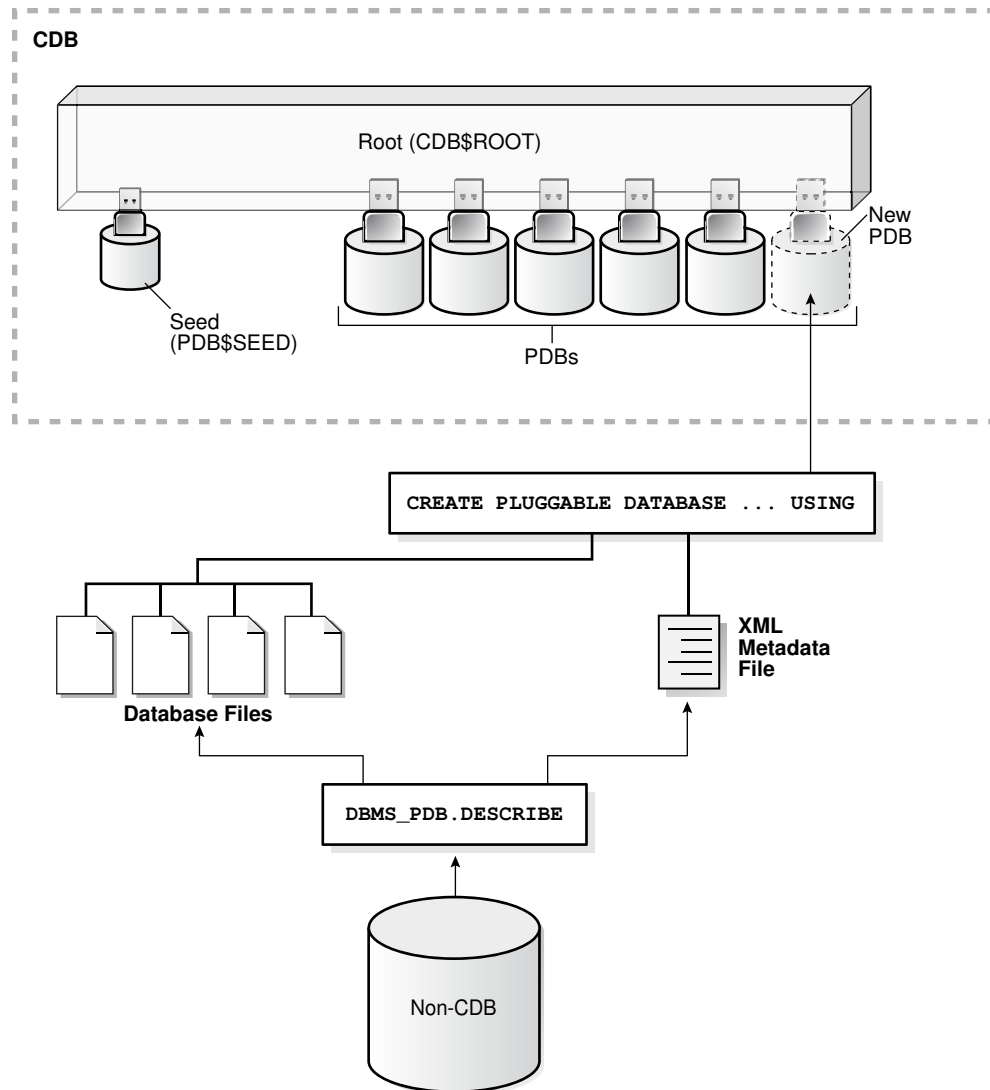

 **See Also:**

- ["Options for Creating a PDB from a Non-CDB"](#)
- *Oracle Database Concepts* for information about Oracle GoldenGate

### 1.3.2.3 Creation of a PDB by Relocating

To relocate a PDB from one CDB to another, use the `CREATE PLUGGABLE DATABASE` statement with the `FROM` clause and `RELOCATE` keyword.

This technique has the following advantages:

- The relocation occurs with minimal downtime.
- The technique keeps the PDB being relocated open in read/write mode during the relocation, and then brings the PDB online in its new location.

You must create a database link at the target CDB, which is the CDB that will contain the relocated PDB. Also, the source PDB must use local undo data.

The following graphic depicts a PDB relocation.

**Figure 1-11 Relocating a PDB**

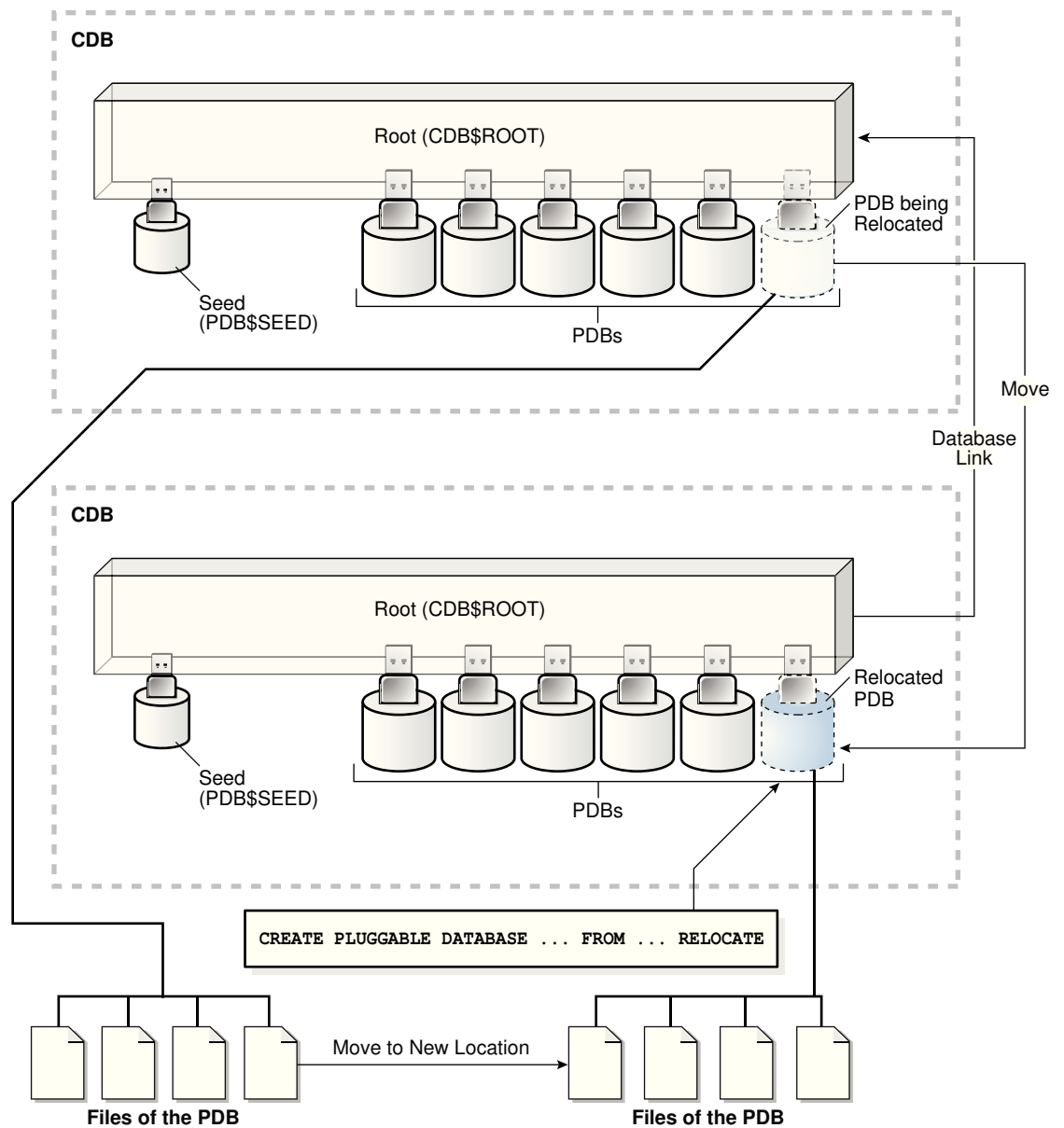

### Example 1-7 PDB Relocation

The following statement, which is issued at a target CDB, relocates `hrpdb` from the source CDB to the target CDB:

```
CREATE PLUGGABLE DATABASE hrpdb FROM hrpdb@lnk_to_source RELOCATE;
```

#### See Also:

- ["Overview of Tablespaces and Database Files in a CDB"](#)
- ["Relocating a PDB"](#)

## 1.3.2.4 Creation of a PDB as a Proxy PDB

A **proxy PDB** provides access to different PDB, called the **referenced PDB**, in a remote CDB.

Proxy PDBs enable you to aggregate data from multiple sources. A SQL statement submitted for execution in a proxy PDB executes within the referenced PDB.

A typical use case is a proxy PDB that references an application root replica. If multiple CDBs have the same application definition (for example, same tables and PL/SQL packages), then you can create a proxy PDB in the application container of the master application root. The referenced PDB for the proxy PDB is the application root in a different CDB. By running installation scripts in the master root, the application roots in the other CDBs become replicas of the master application root.

To create a proxy PDB, use the `CREATE PLUGGABLE DATABASE` statement with the `FROM` clause, which must specify a database link to the referenced PDB in the remote CDB, and the `AS PROXY` clause.

#### Note:

If you plug a proxy PDB directly into `CDB$ROOT`, then you must have created the proxy in `CDB$ROOT`. A proxy of an application PDB must both be plugged in to an application root.

The following graphic shows the creation of a proxy PDB that references a PDB in a remote CDB.



Figure 1-12 Creating a Proxy PDB

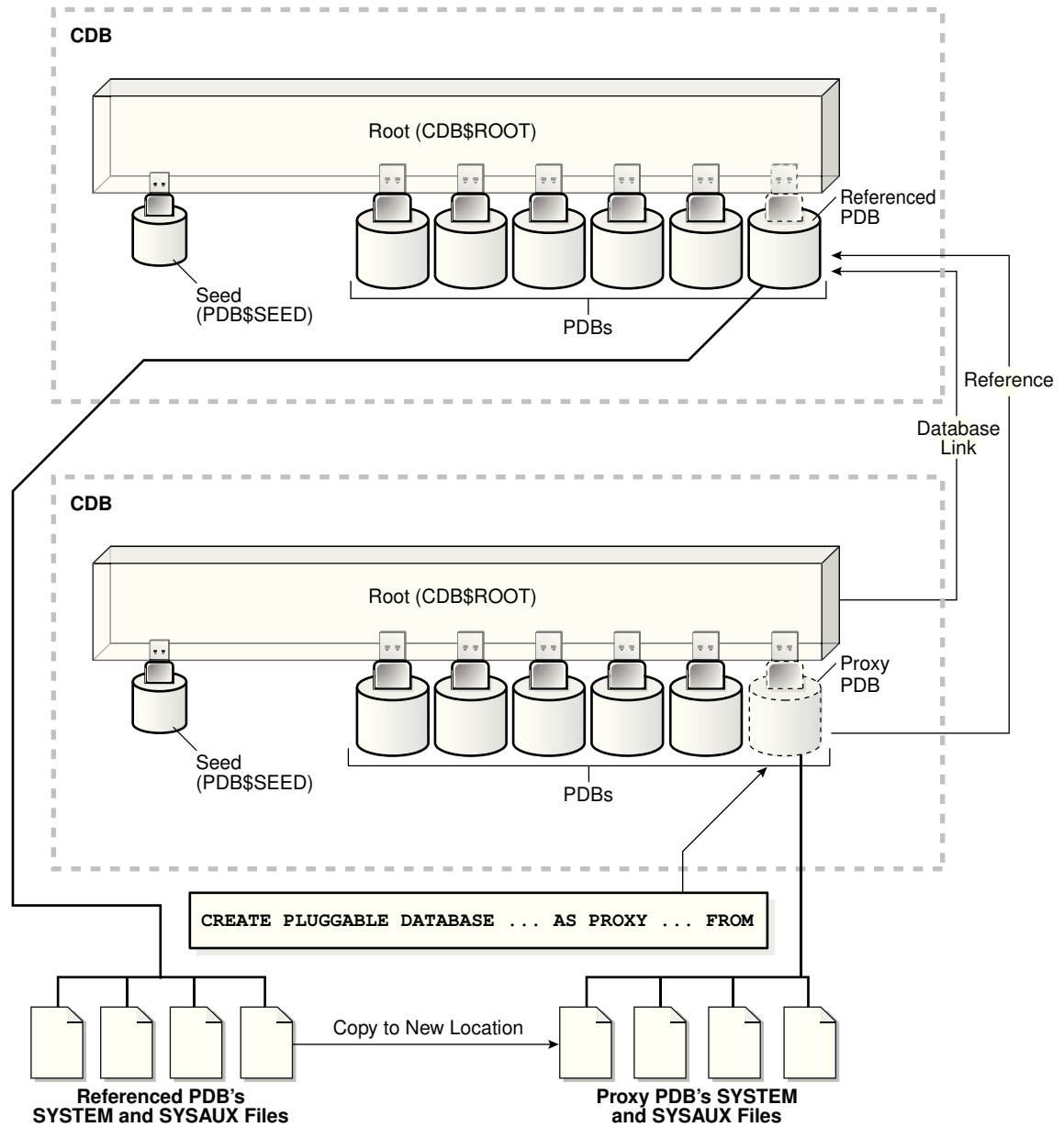

### Example 1-8 Creation of a Proxy PDB

This example creates a proxy PDB named `pdb1`. The referenced PDB is specified using a database link.

```
CREATE PLUGGABLE DATABASE pdb1 AS PROXY FROM pdb1@pdb1_link;
```



**Note:**

"Creating a PDB as a Proxy PDB"

## 1.4 Multitenant Environment Documentation Roadmap

This topic lists the most important topics for understanding and using CDBs, and includes cross-references to the appropriate documentation.

**Table 1-2 Road map for the Multitenant Architecture Documentation**

Category	Topic	Documentation
Concepts	Overview of CDBs and PDBs	" <a href="#">Overview of the Multitenant Architecture</a> "
Administration	Creating and configuring a CDB	" <a href="#">Creating and Configuring a CDB</a> "
Administration	Managing a CDB	" <a href="#">Administering a CDB</a> "
Administration	Creating and configuring PDBs	" <a href="#">Creating and Removing PDBs and Application Containers</a> "
Administration	Managing PDBs	" <a href="#">Administering PDBs</a> "
Administration	Creating and removing application containers	" <a href="#">Creating and Removing Application Containers</a> "
Administration	Administering application containers	" <a href="#">Administering Application Containers</a> "
Performance	Troubleshooting PDBs	<i>Oracle Database Performance Tuning Guide</i>
Monitoring	Viewing information about CDBs and PDBs	" <a href="#">Monitoring CDBs and PDBs</a> "
Backup and Recovery	Performing backup and recovery in a CDB	<i>Oracle Database Backup and Recovery User's Guide</i>
Security	Managing common users, roles, and privileges in a CDB	<i>Oracle Database Security Guide</i>
Miscellaneous	All other tasks relating to managing a CDB or PDB, including Oracle RAC, resource management, data transfer, and so on	This guide is the primary task-oriented intermediate and advanced documentation for managing CDBs. This guide also contains See Also links to books that cover different CDB topics. For example, <i>Oracle Database Utilities</i> explains concepts and tasks specific to PDBs when using Oracle Data Pump.

# 2

## Overview of the Multitenant Architecture

This chapter describes the most important components of the multitenant architecture.

This part contains the following topics:

- [Overview of Containers in a CDB](#)  
A **container** is a collection of schemas, objects, and related structures in a **multitenant container database (CDB)**. Within a CDB, each container has a unique ID and name.
- [Overview of Commonality in the CDB](#)  
In a CDB, every user, role, or object is either common or local. Similarly, a privilege is granted either commonly or locally.
- [Overview of Applications in an Application Container](#)  
Within an application container, an **application** is the named, versioned set of common data and metadata stored in the application root.
- [Overview of Services in a CDB](#)  
Clients must connect to PDBs or application roots using services.
- [Overview of Tablespaces and Database Files in a CDB](#)  
A CDB has the same structure as a non-CDB, except that each PDB and application root has its own set of tablespaces, including its own `SYSTEM`, `SYSAUX`, and undo tablespaces.
- [Overview of Availability in a CDB](#)  
Many availability features that exist for a non-CDB also exist for individual PDBs within a CDB.
- [Overview of Oracle Resource Manager in a CDB](#)  
Using Oracle Resource Manager (Resource Manager), you can create CDB resource plans and set initialization parameters to allocate resources to PDBs.

### 2.1 Overview of Containers in a CDB

A **container** is a collection of schemas, objects, and related structures in a **multitenant container database (CDB)**. Within a CDB, each container has a unique ID and name.

This section contains the following topics:

- [The CDB Root and System Container](#)  
The **CDB root**, also called simply *the root*, is a collection of schemas, schema objects, and nonschema objects to which all PDBs belong.
- [PDBs](#)  
A **PDB** is a user-created set of schemas, objects, and related structures that appears logically to a client application as a separate database.
- [Data Dictionary Architecture in a CDB](#)  
From the user and application perspective, the data dictionary in each container in a CDB is separate, as it would be in a non-CDB.

- **Current Container**  
For a given session, the current container is the one in which the session is running. The current container can be the CDB root, an application root, or a PDB.
- **Cross-Container Operations**  
A **cross-container operation** is a DDL or DML statement that affects multiple containers at once.

## 2.1.1 The CDB Root and System Container

The **CDB root**, also called simply *the root*, is a collection of schemas, schema objects, and nonschema objects to which all PDBs belong.

Every CDB has one and only one root container named `CDB$ROOT`. The root stores the system metadata required to manage PDBs. All PDBs belong to the root. The **system container** is the CDB root and all PDBs that belong to this root.

The CDB root does not store user data. Oracle recommends that you do *not* add common objects to the root or modify Oracle-supplied schemas in the root. However, you can create common users and roles for database administration. A common user with the necessary privileges can switch between containers.

Oracle recommends AL32UTF8 for the root character set. PDBs with different character sets can reside in the same CDB without requiring character set conversion.

### Example 2-1 All Containers in a CDB

The following query, issued by an administrative user connected to the CDB root, lists all containers in the CDB (including the seed and CDB root), ordered by `CON_ID`.

```
SQL> COL NAME FORMAT A15
SQL> SELECT NAME, CON_ID, DBID, CON_UID, GUID FROM V$CONTAINERS ORDER BY
CON_ID;
```

NAME	CON_ID	DBID	CON_UID	GUID
CDB\$ROOT	1	1895287725	1	2003321EDD4F60D6E0534E40E40A41C5
PDB\$SEED	2	2795386505	2795386505	200AC90679F07B55E05396C0E40A23FE
SAAS_SALES_AC	3	1239646423	1239646423	200B4CE0A8DC1D24E05396C0E40AF8EE
SALESPDB	4	3692549634	3692549634	200B4928319C1BCCE05396C0E40A2432
HRPDB	5	3784483090	3784483090	200B4928319D1BCCE05396C0E40A2432



#### See Also:

- ["Common Users in a CDB"](#)
- [" Overview of Configuring and Managing a Multitenant Environment"](#)

## 2.1.2 PDBs

A **PDB** is a user-created set of schemas, objects, and related structures that appears logically to a client application as a separate database.

Every PDB is owned by `SYS`, regardless of which user created the PDB. `SYS` is a [common user](#) in the CDB.

This section contains the following topics:

- [Types of PDBs](#)  
All PDBs are user-created with the `CREATE PLUGGABLE DATABASE` statement except for `PDB$SEED`, which is Oracle-supplied.
- [Purpose of PDBs](#)  
From the point of view of an application, a PDB is a self-contained, fully functional Oracle database. You can consolidate PDBs into a single CDB to achieve economies of scale, while maintaining isolation between PDBs.
- [Proxy PDBs](#)  
A **proxy PDB** refers to a remote PDB, called the **referenced PDB**.
- [Names for PDBs](#)  
Containers in a CDB share the same namespace, which means that they must have unique names within this namespace.
- [Database Links Between PDBs](#)  
By default, a user connected to one PDB must use database links to access objects in a different PDB. This behavior is directly analogous to a user in a non-CDB accessing objects in a different non-CDB.

### 2.1.2.1 Types of PDBs

All PDBs are user-created with the `CREATE PLUGGABLE DATABASE` statement except for `PDB$SEED`, which is Oracle-supplied.

You can create the following types of PDBs.

#### Standard PDB

This type of PDB results from running `CREATE PLUGGABLE DATABASE` *without* specifying the PDB as a seed, proxy PDB, or [application root](#). Its capabilities depend on the container in which you create it:

- PDB plugged in to the [CDB root](#)  
This PDB belongs to the CDB root container and not an [application container](#). This type of PDB cannot use application common objects. See "[Application Common Objects](#)".
- Application PDB  
An [application PDB](#) belongs to exactly one application container. Unlike PDBs plugged in to the CDB root, application PDBs can share a master [application definition](#) within an application container. For example, a `usa_zipcodes` table in an application root might be a [data-linked common object](#), which means it contains data accessible by all application PDBs plugged in to this root. PDBs that do not reside within the application container cannot access its application common objects.

A [refreshable clone PDB](#) is a read-only clone of a source PDB that can receive incremental changes from a source PDB. You can configure the clone PDB to receive the changes automatically or only manually.

A [snapshot copy PDB](#) is created using a storage-level snapshot. Unlike a standard PDB clone, a snapshot copy PDB cannot be unplugged.

### Application Root

Consider an application root as an application-specific root container. It serves as a repository for a master definition of an application back end, including common data and metadata. To create an application root, connect to the CDB root and specify the `AS APPLICATION CONTAINER` clause in a `CREATE PLUGGABLE DATABASE` statement. See "[Application Root](#)".

### Seed PDBs

Unlike a standard PDB, a seed PDB is not intended to support an application. Rather, the seed is a *template* for the creation of PDBs that support applications. A seed can be either of the following:

- Seed PDB plugged in the CDB root (`PDB$SEED`)  
You can use this system-supplied template to create new PDBs either in an application container or the system container. The system container contains exactly one PDB seed. You cannot drop `PDB$SEED`, or add objects to or modify objects within it.
- Application seed PDB  
To accelerate creation of application PDBs within an application container, you can create an optional [application seed](#). An application container contains either zero or one application seed.  
You create an application seed by connecting to the application container and executing the `CREATE PLUGGABLE DATABASE ... AS SEED` statement. See "[Application Seed](#)".

### Proxy PDBs

A [proxy PDB](#) is a PDB that uses a database link to reference a PDB in a remote CDB. When you issue a statement in a proxy PDB while the PDB is open, the statement executes in the referenced PDB.

You must create a proxy PDB while connected to the CDB root or application root. You can alter or drop a proxy PDB just as you can a standard PDB.



#### See Also:

["Overview of PDB Creation"](#)

## 2.1.2.2 Purpose of PDBs

From the point of view of an application, a PDB is a self-contained, fully functional Oracle database. You can consolidate PDBs into a single CDB to achieve economies of scale, while maintaining isolation between PDBs.

You can use PDBs to achieve the following goals:

- Store data specific to an application  
For example, a sales application can have its own dedicated PDB, and a human resources application can have its own dedicated PDB. Alternatively, you can create an [application container](#), which is a named collection of PDBs, to store an application back end containing common data and metadata (see "[About Application Containers](#)").
- Move data into a different CDB  
A database is "pluggable" because you can package it as a self-contained unit, called an [unplugged PDB](#), and then move it into another CDB.
- Perform rapid upgrades  
You can unplug a PDB from CDB at a lower Oracle Database release, and then plug it in to a CDB at a higher release.
- Copy data quickly without loss of availability  
For testing and development, you can clone a PDB while it remains open, storing the clone in the same or a different CDB. Optionally, you can specify the PDB as a [refreshable clone PDB](#). Alternatively, you use the Oracle-supplied [seed PDB](#) or a user-created [application seed](#) to copy new PDBs.
- Reference data in a different CDB  
You can create a [proxy PDB](#) that refers to a different PDB, either in the same CDB or in a separate CDB. When you issue statements in the proxy PDB, they execute in the referenced PDB.
- Isolate grants within PDBs  
A local or common user with appropriate privileges can grant `EXECUTE` privileges on a schema object to `PUBLIC` within an individual PDB.

### See Also:

- "[Benefits of the Multitenant Architecture](#)"
- *Oracle Database Security Guide* to learn how to grant roles and privileges in a CDB

## 2.1.2.3 Proxy PDBs

A **proxy PDB** refers to a remote PDB, called the **referenced PDB**.

Although you issue SQL statements in the proxy (referring) PDB, the statements execute in the referenced PDB. In this respect, a proxy PDB is loosely analogous to a symbolic link file in Linux.

Proxy PDBs provide the following benefits:

- Aggregate data from multiple application models  
Proxy PDBs enable you to build location-transparent applications that can aggregate data from multiple sources. These sources can be in the same data center or distributed across data centers.
- Enable an application root in one CDB to propagate application changes to a different application root  
Assume that CDBs `cdb_prod` and `cdb_test` have the same application model. You create a proxy PDB in an application container in `cdb_prod` that refers to an application root in `cdb_test`. When you run installation and upgrade scripts in the application root in `cdb_prod`, Oracle Database propagates these statements to the proxy PDB, which in turn sends them remotely to the application root in `cdb_test`. In this way, the application root in `cdb_test` becomes a replica of the application root in `cdb_prod`.

To create a proxy PDB, execute `CREATE PLUGGABLE DATABASE` with the `AS PROXY FROM` clause, where `FROM` specifies the referenced PDB name and a database link. The creation statement copies only the data files belonging to the `SYSTEM` and `SYSAUX` tablespaces.

### Example 2-2 Creating a Proxy PDB

This example connects to the container `saas_sales_ac` in a local production CDB. The `sales_admin` common user creates a proxy PDB named `sales_sync_pdb`. This application PDB references an application root named `saas_sales_test_ac` in a remote development CDB, which it accesses using the `cdb_dev_rem` database link. When an application upgrade occurs in `saas_sales_ac` in the production CDB, the upgrade automatically propagates to the application root `saas_sales_test_ac` in the remote development CDB.

```
CONNECT sales_admin@saas_sales_ac
Password: *****

CREATE PLUGGABLE DATABASE sales_sync_pdb AS PROXY FROM
saas_sales_test_ac@cdb_dev_rem;
```



#### Note:

"Creating a Proxy PDB"

## 2.1.2.4 Names for PDBs

Containers in a CDB share the same namespace, which means that they must have unique names within this namespace.

Names for the following containers must not conflict within the same CDB:



- The CDB root
- PDBs plugged in to the CDB root
- Application roots
- Application PDBs

For example, if the same CDB contains the application containers `saas_sales_ac` and `saas_sales_test_ac`, then two application PDBs that are both named `cust1` cannot simultaneously reside in both containers. The namespace rules also prevent creation of a PDB named `cust1pdb` in the CDB root and a PDB named `cust1pdb` in an application root.

PDBs and application root containers must follow the same naming rules as service names. Moreover, because a PDB or application root has a service with its own name, the container name must be unique across all CDBs whose services are exposed through a specific listener. The first character of a user-created container name must be alphanumeric, with remaining characters either alphanumeric or an underscore (`_`). Because service names are case-insensitive, container names are case-insensitive, and are in upper case even if specified using delimited identifiers.

 **See Also:**

- *Oracle Database Net Services Reference* for the rules for service names
- "[General Prerequisites for PDB Creation](#)"

### 2.1.2.5 Database Links Between PDBs

By default, a user connected to one PDB must use database links to access objects in a different PDB. This behavior is directly analogous to a user in a non-CDB accessing objects in a different non-CDB.

#### Figure 2-1 Database Link Between PDBs

In this illustration, a PDB administrator is connected to the PDB named `hrpdb1`. By default, during this user session, `c##dba` cannot query the `emp2` table in `hrpdb2` without specifying a database link.

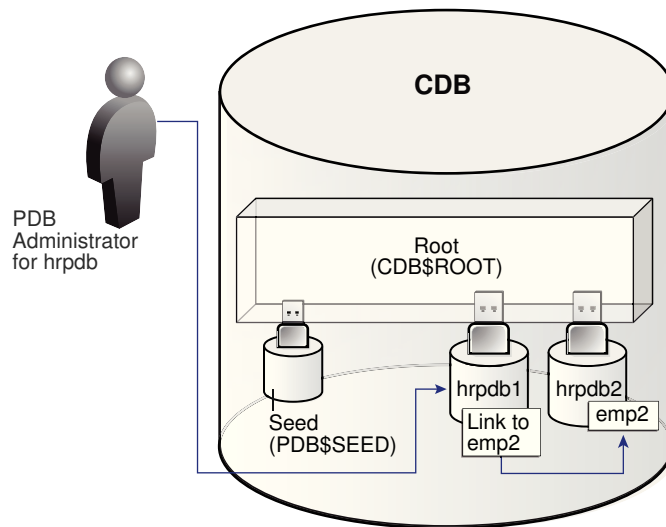

Exceptions to the rule include:

- A [data-linked common object](#), which is accessible by all application PDBs that contain a [data link](#) that points to this object. For example, the application container `saas_sales_ac` might contain the data-linked table `usa_zipcodes` within its application. In this case, common CDB user `c##dba` can connect to an application PDB in this container, and then query `usa_zipcodes` even though the actual table resides in the application root. In this case, no database link is required.
- The `CONTAINERS()` clause in SQL issued from the CDB root or application root. Using this clause, you can query data across all PDBs plugged in to the root.

When creating a proxy PDB, you must specify a database link name in the `FROM` clause of the `CREATE PLUGGABLE DATABASE ... AS PROXY` statement. If the proxy PDB and referenced PDB reside in separate CDBs, then the database link must be defined in the root of the CDB that will contain the proxy PDB. The database link must connect either to the remote referenced PDB or to the CDB root of the remote CDB.

#### See Also:

- ["Overview of Common and Local Objects in a CDB"](#)
- ["About PDB Administration"](#) to learn how to access objects in other PDBs using database links

## 2.1.3 Data Dictionary Architecture in a CDB

From the user and application perspective, the data dictionary in each container in a CDB is separate, as it would be in a non-CDB.

For example, the `DBA_OBJECTS` view in each PDB can show a different number of rows. This dictionary separation enables Oracle Database to manage the PDBs separately from each other and from the root.

This section contains the following topics:

- [Purpose of Data Dictionary Separation](#)  
In a newly created non-CDB that does not yet contain user data, the data dictionary contains only system metadata. For example, the `TAB$` table contains rows that describe only Oracle-supplied tables, for example, `TRIGGER$` and `SERVICE$`.
- [Metadata and Data Links](#)  
The CDB uses an internal linking mechanism to separate data dictionary information.
- [Container Data Objects in a CDB](#)  
A **container data object** is a table or view containing data pertaining to multiple containers or the whole CDB.
- [Data Dictionary Storage in a CDB](#)  
The data dictionary that stores the metadata for the CDB as a whole is stored only in the system tablespaces.

### 2.1.3.1 Purpose of Data Dictionary Separation

In a newly created non-CDB that does not yet contain user data, the data dictionary contains only system metadata. For example, the `TAB$` table contains rows that describe only Oracle-supplied tables, for example, `TRIGGER$` and `SERVICE$`.

The following graphic depicts three underlying data dictionary tables, with the red bars indicating rows describing the system.

**Figure 2-2 Unmixed Data Dictionary Metadata in a Non-CDB**

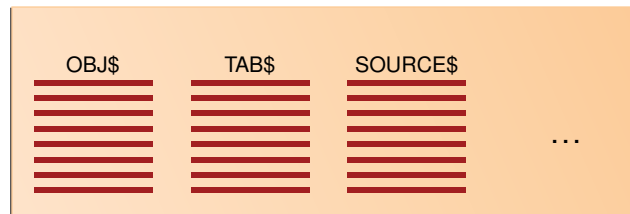

If users create their own schemas and tables in this non-CDB, then the data dictionary now contains some rows that describe Oracle-supplied entities, and other rows that describe user-created entities. For example, the `TAB$` dictionary table now has a row describing `employees` and a row describing `departments`.

**Figure 2-3 Mixed Data Dictionary Metadata in a Non-CDB**



In a CDB, the data dictionary metadata is split between the root and the PDBs. In the following figure, the `employees` and `departments` tables reside in a PDB. The data dictionary for this user data also resides in the PDB. Thus, the `TAB$` table in the PDB has a row for the `employees` table and a row for the `departments` table.

**Figure 2-4 Data Dictionary Architecture in a CDB**

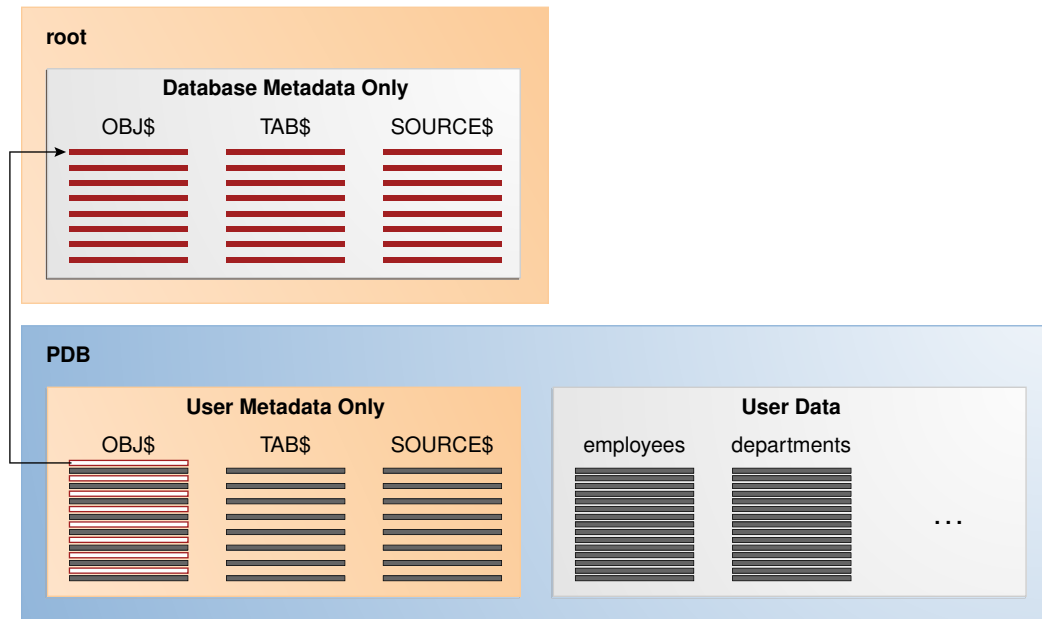

The preceding graphic shows that the data dictionary in the PDB contains pointers to the data dictionary in the root. Internally, Oracle-supplied objects such as data dictionary table definitions and PL/SQL packages are represented *only* in the root. This architecture achieves two main goals within the CDB:

- Reduction of duplication  
For example, instead of storing the source code for the `DBMS_ADVISOR` PL/SQL package in every PDB, the CDB stores it only in `CDB$ROOT`, which saves disk space.
- Ease of database upgrade  
If the definition of a data dictionary table existed in every PDB, and if the definition were to change in a new release, then each PDB would need to be upgraded separately to capture the change. Storing the table definition only once in the root eliminates this problem.

### 2.1.3.2 Metadata and Data Links

The CDB uses an internal linking mechanism to separate data dictionary information. Specifically, Oracle Database uses the following automatically managed pointers:

- Metadata links  
Oracle Database stores metadata about dictionary objects only in the CDB root. For example, the column definitions for the `OBJ$` dictionary table, which underlies the `DBA_OBJECTS` data dictionary view, exist only in the root. As depicted in

Figure 2-4, the `OBJ$` table in each PDB uses an internal mechanism called a [metadata link](#) to point to the definition of `OBJ$` stored in the root.

The *data* corresponding to a metadata link resides in its PDB, not in the root. For example, if you create table `mytable` in `hrpdb` and add rows to it, then the rows are stored in the PDB data files. The data dictionary views in the PDB and in the root contain different rows. For example, a new row describing `mytable` exists in the `OBJ$` table in `hrpdb`, but not in the `OBJ$` table in the CDB root. Thus, a query of `DBA_OBJECTS` in the CDB root and `DBA_OBJECTS` in `hrpdb` shows different results.

- Data links

 **Note:**

Data links were called *object links* in Oracle Database 12c Release 1 (12.1.0.2).

In some cases, Oracle Database stores the data (not only metadata) for an object only once in the application root. An application PDB uses an internal mechanism called a [data link](#) to refer to the objects in the application root. The application PDB in which the data link was created also stores the data link description. A data link inherits the data type of the object to which it refers.

- Extended data link

An extended data link is a hybrid of a data link and a metadata link. Like a data link, an extended data link refers to an object in an application root. However, the extended data link also refers to a corresponding object in the application PDB. Like a metadata link, the object in the application PDB inherits metadata from the corresponding object in the application root.

When queried in the application root, an extended data-linked object fetches rows only from the application root. However, when queried in an application PDB, an extended data-linked object fetches rows from both the application root and application PDB.

Oracle Database automatically creates and manages metadata and data links to `CDB$ROOT`. Users cannot add, modify, or remove these links.

 **See Also:**

- ["Application Common Objects"](#)
- *Oracle Database Concepts* for an overview of the data dictionary

### 2.1.3.3 Container Data Objects in a CDB

A **container data object** is a table or view containing data pertaining to multiple containers or the whole CDB.

Container data privileges support a general requirement in which multiple PDBs reside in a single CDB, but with different local administration requirements. For example, if

application DBAs do not want to administer locally, then they can grant container data privileges on appropriate views to the common users. In this case, the CDB administrator can access the data for these PDBs. In contrast, PDB administrators who do not want the CDB administrator accessing their data do not grant container data privileges.

Examples of container data objects are Oracle-supplied views whose names begin with `V$` and `CDB_`. All container data objects have a `CON_ID` column. The following table shows the meaning of the values for this column.

**Table 2-1 Container ID Values**

Container ID	Rows pertain to
0	Whole CDB, or non-CDB
1	CDB\$ROOT
2	PDB\$SEED
All Other IDs	User-created PDBs, application roots, or application seeds

In a CDB, for every `DBA_` view, a corresponding `CDB_` view exists. The owner of a `CDB_` view is the owner of the corresponding `DBA_` view. The following graphic shows the relationship among the different categories of dictionary views:

**Figure 2-5 Dictionary Views in a CDB**

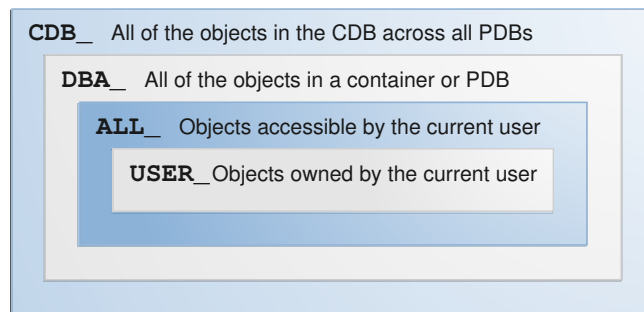

When the current container is a PDB, a user can view data dictionary information for the current PDB only. To an application connected to a PDB, the data dictionary appears as it would for a non-CDB. When the current container is the root, however, a common user can query `CDB_` views to see metadata for the root and for PDBs for which this user is privileged.

 **Note:**

When queried from the root container, `CDB_` and `V$` views implicitly convert data to the AL32UTF8 character set. If a character set needs more bytes to represent a character when converted to AL32UTF8, and if the view column width cannot accommodate data from a specific PDB, then data truncation is possible.

The following table shows a scenario involving queries of CDB\_views. Each row describes an action that occurs after the action in the preceding row.

**Table 2-2 Querying CDB\_Views**

Operation	Description
<pre>SQL&gt; CONNECT SYSTEM Enter password: ***** Connected.</pre>	The SYSTEM user, which is common to all containers in the CDB, connects to the root (see " <a href="#">Common Users in a CDB</a> ").
<pre>SQL&gt; SELECT COUNT(*) FROM CDB_USERS WHERE CON_ID=1;  COUNT(*) -----          41</pre>	SYSTEM queries CDB_USERS to obtain the number of common users in the CDB. The output indicates that 41 common users exist.
<pre>SQL&gt; SELECT COUNT(DISTINCT(CON_ID)) FROM CDB_USERS;  COUNT(DISTINCT(CON_ID)) -----                            4</pre>	SYSTEM queries CDB_USERS to determine the number of distinct containers in the CDB.
<pre>SQL&gt; CONNECT SYSTEM@hrpdb Enter password: ***** Connected.</pre>	The SYSTEM user now connects to the PDB named hrpdb.
<pre>SQL&gt; SELECT COUNT(*) FROM CDB_USERS;  COUNT(*) -----          45</pre>	SYSTEM queries CDB_USERS. The output indicates that 45 users exist. Because SYSTEM is not connected to the root, the CDB_USERS view shows the same output as DBA_USERS. Because DBA_USERS only shows the users in the <i>current</i> container, it shows 45.

 **See Also:**

"[About CDB and Container Information in Views](#)" to learn more about container data objects

### 2.1.3.4 Data Dictionary Storage in a CDB

The data dictionary that stores the metadata for the CDB as a whole is stored only in the system tablespaces.

The data dictionary that stores the metadata for a specific PDB is stored in the self-contained tablespaces dedicated to this PDB. The PDB tablespaces contain both the data and metadata for an application back end. Thus, each set of data dictionary tables is stored in its own dedicated set of tablespaces.

#### See Also:

- *Oracle Database Concepts* for an overview of the data dictionary
- "[Overview of Tablespaces and Database Files in a CDB](#)"

### 2.1.4 Current Container

For a given session, the current container is the one in which the session is running. The current container can be the CDB root, an application root, or a PDB.

Each session has exactly one current container at any point in time. Because the data dictionary in each container is separate, Oracle Database uses the data dictionary in the current container for name resolution and privilege authorization.

#### See Also:

- "[About the Current Container](#)"

### 2.1.5 Cross-Container Operations

A **cross-container operation** is a DDL or DML statement that affects multiple containers at once.

Only a common user connected to either the CDB root or an application root can perform cross-container operations. A cross-container operation can affect:

- The CDB itself
- Multiple containers within a CDB
- Multiple phenomena such as common users or common roles that are represented in multiple containers
- A container to which the user issuing the DDL or DML statement is currently not connected

Examples of cross-container DDL operations include user `SYSTEM` granting a privilege commonly to another common user (see "[Roles and Privileges Granted Commonly in](#)



a CDB"), and an `ALTER DATABASE . . . RECOVER` statement that applies to the entire CDB.

When you are connected to either the CDB root or an application root, you can execute a single DML statement to modify tables or views in multiple PDBs within the container. The database infers the target PDBs from the value of the `CON_ID` column specified in the DML statement. If no `CON_ID` is specified, then the database uses the `CONTAINERS_DEFAULT_TARGET` property specified by the `ALTER PLUGGABLE DATABASE CONTAINERS DEFAULT TARGET` statement.

### Example 2-3 Updating Multiple PDBs in a Single DML Statement

In this example, your goal is to set the `country_name` column to the value `USA` in the `sh.sales` table. This table exists in two separate PDBs, with container IDs of 7 and 8. Both PDBs are in the application container named `saas_sales_ac`. You can connect to the application root as an administrator, and make the update as follows:

```
CONNECT sales_admin@saas_sales_ac
Password: *****

UPDATE CONTAINERS(sh.sales) sal
  SET sal.country_name = 'USA'
  WHERE sal.CON_ID IN (7,8);
```

In the preceding `UPDATE` statement, `sal` is an alias for `CONTAINERS(sh.sales)`.

#### See Also:

- ["Common Users in a CDB"](#)
- ["Administering a CDB"](#)

## 2.2 Overview of Commonality in the CDB

In a CDB, every user, role, or object is either common or local. Similarly, a privilege is granted either commonly or locally.

This section contains the following topics:

- [About Commonality in a CDB](#)  
A common phenomenon defined in a root is the same in all containers plugged in to this root.
- [Overview of Common and Local Users in a CDB](#)  
If a user account owns objects that define the database, then this user account is common. User accounts that are *not* Oracle-supplied are either local or common.
- [Overview of Common and Local Roles in a CDB](#)  
User-created roles are either local or common. Common roles are either common to the CDB itself or to a specific application container.

- [Overview of Privilege and Role Grants in a CDB](#)  
Just as in a non-CDB, users in a CDB can grant and be granted roles and privileges. Roles and privileges in a CDB, however, are either locally or commonly granted.
- [Overview of Common and Local Objects in a CDB](#)  
A **common object** is defined in either the CDB root or an application root, and can be referenced using metadata links or object links. A local object is every object that is not a common object.
- [Overview of Common Audit Configurations](#)  
For both mixed mode and unified auditing, a **common audit configuration** is visible and enforced across all PDBs.
- [Overview of PDB Lockdown Profiles](#)  
A **PDB lockdown profile** is a named set of features that control operations available to users connected to a PDB. For example, a PDB lockdown profile can disable privileges that come with the `ALTER SYSTEM` statement.

## 2.2.1 About Commonality in a CDB

A common phenomenon defined in a root is the same in all containers plugged in to this root.

This section contains the following topics:

- [Principles of Commonality](#)  
In a CDB, a phenomenon can be common within either the system container (the CDB itself), or within a specific application container.
- [Namespaces in a CDB](#)  
In a CDB, the namespace for every object is scoped to its container.

### 2.2.1.1 Principles of Commonality

In a CDB, a phenomenon can be common within either the system container (the CDB itself), or within a specific application container.

For example, if you create a common user account while connected to `CDB$ROOT`, then this user account is common to all PDBs and application roots in the CDB. If you create an application common user account while connected to an application root, however, then this user account is common only to the PDBs in this application container.

Within the context of `CDB$ROOT` or an application root, the principles of commonality are as follows:

- A common phenomenon is the same in every existing and future container.  
Therefore, a common user defined in the CDB root has the same identity in every PDB plugged in to the CDB root; a common user defined in an application root has the same identity in every application PDB plugged in to this application root. In contrast, a local phenomenon is scoped to exactly one existing container.
- Only a common user can alter the existence of common phenomena.  
More precisely, only a common user logged in to either the CDB root or an application root can create, destroy, or modify attributes of a user, role, or object that is common to the current container.

## 2.2.1.2 Namespaces in a CDB

In a CDB, the namespace for every object is scoped to its container.

The following principles summarize the scoping rules:

- From an application perspective, a PDB is indistinguishable from a non-CDB.
- Local phenomena are created within and restricted to a single container.



### Note:

In this topic, the word “phenomenon” means “user account, role, or database object.”

- Common phenomena are defined in a CDB root or application root, and exist in all PDBs that are or will be plugged into this root.

The preceding principles have implications for local and common phenomena.

### Local Phenomena

A local phenomenon must be uniquely named *within* a container, but not across all containers in the CDB. Identically named local phenomena in different containers are distinct. For example, local user `sh` in one PDB does not conflict with local user `sh` in another PDB.

### CDB\$ROOT Common Phenomena

Common phenomena defined in `CDB$ROOT` exist in multiple containers and must be unique within each of these namespaces. For example, the CDB root includes predefined common users such as `SYSTEM` and `SYS`. To ensure namespace separation, Oracle Database prevents creation of a `SYSTEM` user within another container.

To ensure namespace separation, the name of user-created common phenomena in the CDB root must begin with the value specified by the `COMMON_USER_PREFIX` initialization parameter. The default prefix is `c##` or `C##`. The names of all *other* user-created phenomena must *not* begin with `c##` or `C##`. For example, you cannot create a local user in `hrpdb` named `c##hr`, nor can you create a common user in the CDB root named `hr`.

### Application Common Phenomena

Within an application container, names for local and application common phenomena must not conflict.

- Application common users and roles

The same principles apply to application common users as to CDB common users. The difference is that for CDB common users, the default value for the common user prefix is `c##` or `C##`, whereas in application root the default value for the common user prefix is the empty string.

The multitenant architecture assumes that you create application PDBs from an application root, or convert a single-tenant application to a multitenant application.
- Application common objects

The multitenant architecture assumes that you create application common objects in the application root. Later, you add data locally within the application PDBs. However, Oracle Database supports creation of *local* tables within an application PDB. In this case, the local tables reside in the same namespace as application common objects within the application PDB.



**See Also:**

*Oracle Database Security Guide* to learn more about common users and roles

## 2.2.2 Overview of Common and Local Users in a CDB

If a user account owns objects that define the database, then this user account is common. User accounts that are *not* Oracle-supplied are either local or common.

A CDB common user is a common user that is created in the **CDB root**. An **application common user** is a user that is created in an application root, and is common only within this application container.

The following graphic shows the possible user account types in a CDB.

**Figure 2-6 User Accounts in a CDB**

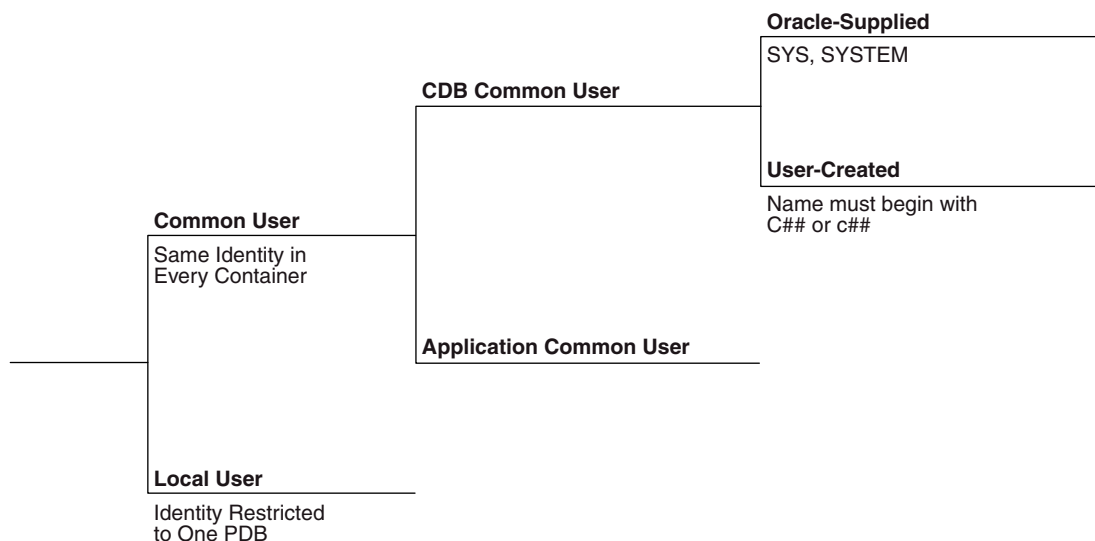

A CDB common user can connect to *any* container in the CDB to which it has sufficient privileges. In contrast, an application common user can only connect to the application root in which it was created, or a PDB that is plugged in to this application root, depending on its privileges.

This section contains the following topics:

- [Common Users in a CDB](#)  
Within the context of either the system container (CDB) or an application container, a **common user** is a database user that has the same identity in the root and in every existing and future PDB within this container.
- [Local Users in a CDB](#)  
A **local user** is a database user that is not common and can operate only within a single PDB.

**See Also:**

*Oracle Database Security Guide* for an overview of common and local users

### 2.2.2.1 Common Users in a CDB

Within the context of either the system container (CDB) or an application container, a **common user** is a database user that has the same identity in the root and in every existing and future PDB within this container.

Every common user can connect to and perform operations within the root of its container, and within any PDB in which it has sufficient privileges. Some administrative tasks must be performed by a common user. Examples include creating a PDB and unplugging a PDB.

For example, `SYSTEM` is a CDB common user with DBA privileges. Thus, `SYSTEM` can connect to the CDB root and any PDB in the database. You might create a common user `saas_sales_admin` in the `saas_sales` application container. In this case, the `saas_sales_admin` user could *only* connect to the `saas_sales` application root or to an application PDB within the `saas_sales` application container.

Every common user is either Oracle-supplied or user-created. Examples of Oracle-supplied common users are `SYS` and `SYSTEM`. Every user-created common user is either a CDB common user, or an application common user.

[Figure 2-7](#) shows sample users and schemas in two PDBs: `hrpdb` and `salespdb`. `SYS` and `c##dba` are CDB common users who have schemas in `CDB$ROOT`, `hrpdb`, and `salespdb`. Local users `hr` and `rep` exist in `hrpdb`. Local users `hr` and `rep` also exist in `salespdb`.

Figure 2-7 Users and Schemas in a CDB

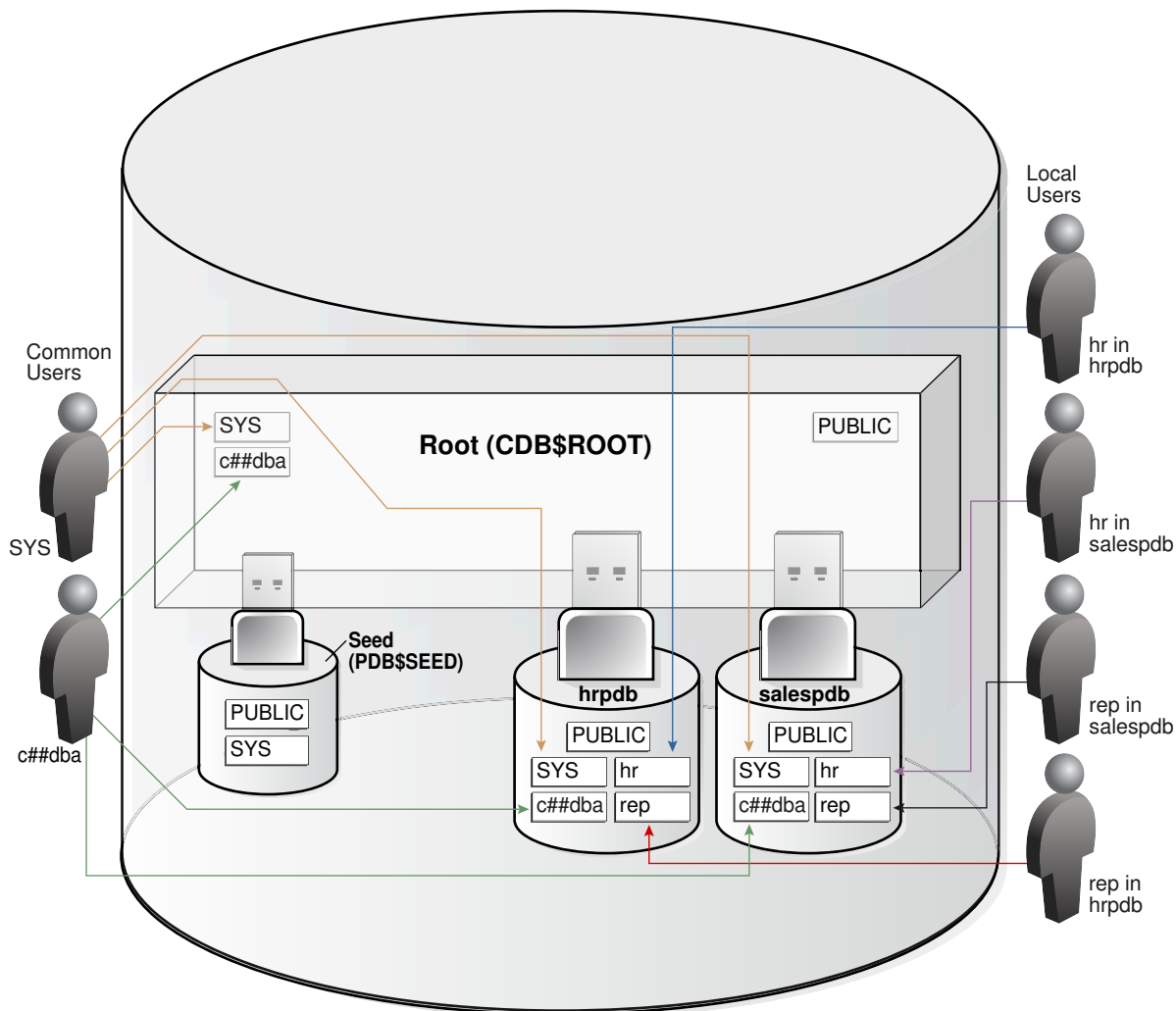

Common users have the following characteristics:

- A common user can log in to any container (including CDB\$ROOT) in which it has the CREATE SESSION privilege.

A common user need not have the same privileges in every container. For example, the c##dba user may have the privilege to create a session in hrpdb and in the root, but *not* to create a session in salespdb. Because a common user with the appropriate privileges can switch between containers, a common user in the root can administer PDBs.

- An application common user does not have the CREATE SESSION privilege in any container outside its own application container.

Thus, an application common user is restricted to its own application container. For example, the application common user created in the saas\_sales application can connect only to the application root and the PDBs in the saas\_sales application container.

- The names of user-created CDB common users must follow the naming rules for other database users. Additionally, the names must begin with the characters

specified by the `COMMON_USER_PREFIX` initialization parameter, which are `c##` or `C##` by default. Oracle-supplied common user names and user-created application common user names do not have this restriction.

No local user name may begin with the characters `c##` or `C##`.

- Every common user is uniquely named across all PDBs within the container (either the system container or a specific application container) in which it was created.

A CDB common user is defined in the CDB root, but must be able to connect to every PDB with the same identity. An application common user resides in the application root, and may connect to every application PDB *in its container* with the same identity.

#### See Also:

- *Oracle Database Security Guide* to learn about common user accounts
- *Oracle Database Reference* to learn about `COMMON_USER_PREFIX`

### 2.2.2.2 Local Users in a CDB

A **local user** is a database user that is not common and can operate only within a single PDB.

Local users have the following characteristics:

- A local user is specific to a PDB and may own a schema in this PDB.  
In [Figure 2-7](#), local user `hr` on `hrpdb` owns the `hr` schema. On `salespdb`, local user `rep` owns the `rep` schema, and local user `hr` owns the `hr` schema.

- A local user can administer a PDB, including opening and closing it.

A common user with `SYSDBA` privileges can grant `SYSDBA` privileges to a local user. In this case, the privileged user remains local.

- A local user in one PDB cannot log in to another PDB or to the CDB root.

For example, when local user `hr` connects to `hrpdb`, `hr` cannot access objects in the `sh` schema that reside in the `salespdb` database without using a database link. In the same way, when local user `sh` connects to the `salespdb` PDB, `sh` cannot access objects in the `hr` schema that resides in `hrpdb` without using a database link.

- The name of a local user must not begin with the characters `c##` or `C##`.
- The name of a local user must only be unique within its PDB.

The user name and the PDB in which that user schema is contained determine a unique local user. [Figure 2-7](#) shows that a local user and schema named `rep` exist on `hrpdb`. A completely independent local user and schema named `rep` exist on the `salespdb` PDB.

The following table describes a scenario involving the CDB in [Figure 2-7](#). Each row describes an action that occurs after the action in the preceding row. Common user `SYSTEM` creates local users in two PDBs.

**Table 2-3 Local Users in a CDB**

Operation	Description
<pre>SQL&gt; CONNECT SYSTEM@hrpdb Enter password: ***** Connected.</pre>	<p>SYSTEM connects to the hrpdb container using the service name hrpdb.</p>
<pre>SQL&gt; CREATE USER rep IDENTIFIED BY password;  User created.  SQL&gt; GRANT CREATE SESSION TO rep;  Grant succeeded.</pre>	<p>SYSTEM now creates a local user rep and grants the CREATE SESSION privilege in this PDB to this user. The user is local because common users can only be created by a common user connected to the root.</p>
<pre>SQL&gt; CONNECT rep@salespdb Enter password: ***** ERROR: ORA-01017: invalid username/password; logon denied</pre>	<p>The rep user, which is local to hrpdb, attempts to connect to salespdb. The attempt fails because rep does not exist in PDB salespdb. This behavior mimics the behavior of non-CDBs. A user account on one non-CDB is independent of user accounts on a different non-CDB.</p>
<pre>SQL&gt; CONNECT SYSTEM@salespdb Enter password: ***** Connected.</pre>	<p>SYSTEM connects to the salespdb container using the service name salespdb.</p>
<pre>SQL&gt; CREATE USER rep IDENTIFIED BY password;  User created.  SQL&gt; GRANT CREATE SESSION TO rep;  Grant succeeded.</pre>	<p>SYSTEM creates a local user rep in salespdb and grants the CREATE SESSION privilege in this PDB to this user. Because the name of a local user must only be unique within its PDB, a user named rep can exist in both salespdb and hrpdb.</p>
<pre>SQL&gt; CONNECT rep@salespdb Enter password: ***** Connected.</pre>	<p>The rep user successfully logs in to salespdb.</p>



 **See Also:**

*Oracle Database Security Guide* to learn about local user accounts

## 2.2.3 Overview of Common and Local Roles in a CDB

User-created roles are either local or common. Common roles are either common to the CDB itself or to a specific application container.

Every Oracle-supplied role is common, for example, the predefined `DBA` role. In Oracle-supplied scripts, every privilege or role granted to Oracle-supplied users and roles is granted commonly, with one exception: system privileges are granted locally to the common role `PUBLIC`.

This section contains the following topics:

- [Common Roles in a CDB](#)  
A **common role** exists either in the CDB root or an application root, and applies to every PDB within the root container (either the CDB or the application container).
- [Local Roles in a CDB](#)  
A **local role** exists only in a single PDB, just as a role in a non-CDB exists only in the non-CDB.

 **See Also:**

["Grants to PUBLIC in a CDB"](#)

### 2.2.3.1 Common Roles in a CDB

A **common role** exists either in the CDB root or an application root, and applies to every PDB within the root container (either the CDB or the application container).

Common roles are useful for cross-container operations, ensuring that a common user has a role in every PDB. Every common role is one of the following types:

- Oracle-supplied  
All Oracle-supplied roles, such as `DBA` and `PUBLIC`, are common to the CDB.
- User-created  
Create a common role by executing `CREATE ROLE ... CONTAINER=ALL` in either the CDB root or application root, which determines the container to which the role is common. The standard naming conventions apply. Additionally, the names of CDB common roles must begin with the characters specified by the `COMMON_USER_PREFIX` initialization parameter, which are `c##` or `C##` by default.

The scope of the role is the scope of the root within which it is defined. If you define the role in `CDB$ROOT`, then its scope is the entire CDB. If you define the role within application root, then its scope is the application container.

 **See Also:**

- ["Cross-Container Operations"](#)
- *Oracle Database Security Guide* to learn how to manage common roles
- *Oracle Database SQL Language Reference* to learn about the `CREATE ROLE` statement

### 2.2.3.2 Local Roles in a CDB

A **local role** exists only in a single PDB, just as a role in a non-CDB exists only in the non-CDB.

A local role can only contain roles and privileges that apply within the container in which the role exists. For example, if you create the local role `pdbadmin` in `hrpdb`, then the scope of this role is restricted to this PDB.

PDBs in the same CDB, or in the same application container, may contain local roles with the same name. For example, the user-created role `pdbadmin` may exist in both `hrpdb` and `salespdb`. However, these roles are completely independent of each other, just as they would be in separate non-CDBs.

 **See Also:**

*Oracle Database Security Guide* to learn how to manage local roles

### 2.2.4 Overview of Privilege and Role Grants in a CDB

Just as in a non-CDB, users in a CDB can grant and be granted roles and privileges. Roles and privileges in a CDB, however, are either locally or commonly granted.

A privilege or role granted locally is exercisable only in the PDB in which it was granted. A privilege or role granted commonly is exercisable in every existing and future PDB in the container—either the CDB or an application container—in which it was granted.

Users and roles may be common or local. However, a privilege is *in itself* neither common nor local. If a user grants a privilege locally using the `CONTAINER=CURRENT` clause, then the grantee has a privilege exercisable only in the current container. If a user connects to either the CDB root or an application root, and if this user grants a privilege commonly using the `CONTAINER=ALL` clause, then the grantee has this privilege in any existing or future PDB within the current container.

This section contains the following topics:

- [Principles of Privilege and Role Grants in a CDB](#)  
In a CDB, every act of granting, whether local or common, occurs within a container. The container may be the CDB root, an application root, or a PDB.

- [Privileges and Roles Granted Locally in a CDB](#)  
Roles and privileges may be granted locally to users and roles *regardless* of whether the grantees, grantors, or roles being granted are local or common.
- [Roles and Privileges Granted Commonly in a CDB](#)  
Privileges and common roles may be granted commonly.
- [Grants to PUBLIC in a CDB](#)  
In a CDB, PUBLIC is a common role. In a PDB, privileges granted locally to PUBLIC enable all local and common user account to exercise these privileges in this PDB only.
- [Grants of Privileges and Roles: Scenario](#)  
In this scenario, SYSTEM creates common user c##dba and tries to give this user privileges to query a table in the hr schema in hrpdb.



**See Also:**

*Oracle Database Security Guide* to learn how to manage common privileges

## 2.2.4.1 Principles of Privilege and Role Grants in a CDB

In a CDB, every act of granting, whether local or common, occurs within a container. The container may be the CDB root, an application root, or a PDB.

If the current container is the CDB root, then granting commonly means granting to all containers in the CDB. If the current container is an application root, however, then granting commonly means granting to all PDBs in the current application container.

The basic principles of granting are as follows:

- Both common and local phenomena may grant and be granted locally.
- Only common phenomena may grant or be granted commonly.

Local users, roles, and privileges are restricted to a particular PDB. Thus, local users may not grant roles and privileges commonly, and local roles and privileges may not be granted commonly.

The following sections describe the implications of the preceding principles.

## 2.2.4.2 Privileges and Roles Granted Locally in a CDB

Roles and privileges may be granted locally to users and roles *regardless* of whether the grantees, grantors, or roles being granted are local or common.

The following table explains the valid possibilities for locally granted roles and privileges.

**Table 2-4 Local Grants**

Phenomenon	May Grant Locally	May Be Granted Locally	May Receive a Role or Privilege Granted Locally
Common User	Yes	N/A	Yes

**Table 2-4 (Cont.) Local Grants**

Phenomenon	May Grant Locally	May Be Granted Locally	May Receive a Role or Privilege Granted Locally
Local User	Yes	N/A	Yes
Common Role	N/A	Yes <sup>1</sup>	Yes
Local Role	N/A	Yes <sup>2</sup>	Yes
Privilege	N/A	Yes	N/A

- <sup>1</sup> Privileges in this role are available to the grantee only in the container in which the role was granted, regardless of whether the privileges were granted to the role locally or commonly.
- <sup>2</sup> Privileges in this role are available to the grantee only in the container in which the role was granted and created.

This section contains the following topics:

- [What Makes a Privilege or Role Grant Local](#)  
To grant a role or privilege locally, use the `GRANT` statement with the `CONTAINER=CURRENT` clause, which is the default.
- [Roles and Privileges Granted Locally](#)  
A user or role may be locally granted a *privilege* (`CONTAINER=CURRENT`).

### 2.2.4.2.1 What Makes a Privilege or Role Grant Local

To grant a role or privilege locally, use the `GRANT` statement with the `CONTAINER=CURRENT` clause, which is the default.

Specifically, a role or privilege is granted locally only when the following criteria are met:

- The grantor has the necessary privileges to grant the specified role or privileges.  
For system roles and privileges, the grantor must have the `ADMIN OPTION` for the role or privilege being granted. For object privileges, the grantor must have the `GRANT OPTION` for the privilege being granted.
- The grant applies to only one container.  
By default, the `GRANT` statement includes the `CONTAINER=CURRENT` clause, which indicates that the privilege or role is granted locally.

#### Example 2-4 Granting a Privilege Locally

In this example, both `SYSTEM` and `c##hr_admin` are common users. The example connects to `hrpdb` as `SYSTEM` (which has administrator privileges), and then locally grants read privileges on the `employees` table to `c##hr_admin`. This grant applies *only* to `c##hr_admin` within `hrpdb`, not within any other PDBs.

```
CONNECT SYSTEM@hrpdb
Enter password: password
Connected.
```

```
GRANT READ ON employees TO c##hr_admin CONTAINER=CURRENT;
```

 **See Also:**

*Oracle Database Security Guide* to learn more about granting local roles and privileges

### 2.2.4.2.2 Roles and Privileges Granted Locally

A user or role may be locally granted a *privilege* (`CONTAINER=CURRENT`).

For example, a `READ ANY TABLE` privilege granted locally to a local or common user in `hrpdb` applies only to *this* user in *this* PDB. Analogously, the `READ ANY TABLE` privilege granted to user `hr` in a non-CDB has no bearing on the privileges of an `hr` user that exists in a separate non-CDB.

A user or role may be locally granted a *role* (`CONTAINER=CURRENT`). As shown in [Table 2-4](#), a *common* role may receive a privilege granted *locally*. For example, the common role `c##dba` may be granted the `READ ANY TABLE` privilege locally in `hrpdb`. If the `c##cdb` common role is granted locally, then privileges in the role apply *only* in the container in which the role is granted. In this example, a common user who has the `c##dba` role does not, because of a privilege granted locally to this role in `hrpdb`, have the right to exercise this privilege in any PDB other than `hrpdb`.

 **See Also:**

*Oracle Database Security Guide* to learn how to grant roles and privileges in a CDB

### 2.2.4.3 Roles and Privileges Granted Commonly in a CDB

Privileges and common roles may be granted commonly.

User accounts or roles may be granted roles and privileges commonly only if the grantees and grantors are both *common*. If a role is being granted commonly, then the role itself must be common. The following table explains the possibilities for common grants.

**Table 2-5 Common Grants**

Phenomenon	May Grant Commonly	May Be Granted Commonly	May Receive Roles and Privileges Granted Commonly
Common User Account	Yes	N/A	Yes
Local User Account	No	N/A	No
Common Role	N/A	Yes <sup>1</sup>	Yes
Local Role	N/A	No	No
Privilege	N/A	Yes	N/A

- 1 Privileges that were granted commonly to a common role are available to the grantee across all containers. In addition, any privilege granted locally to a common role is available to the grantee only in the container in which that privilege was granted to the common role.

This section contains the following topics:

- [What Makes a Grant Common](#)  
The `CONTAINER=ALL` clause specifies that the privilege or role is being granted commonly.
- [Roles and Privileges Granted Commonly](#)  
A common user account or role may be granted a *privilege* commonly (`CONTAINER=ALL`).



#### See Also:

*Oracle Database Security Guide* to learn more about common grants

### 2.2.4.3.1 What Makes a Grant Common

The `CONTAINER=ALL` clause specifies that the privilege or role is being granted commonly.

A role or privilege is granted commonly when the following criteria are met:

- The grantor is a common user.  
The user that performs the grant is either common to the CDB itself, or common to a specific application container.
- The grantee is a common user or common role.  
The recipient of the grant is either common to the CDB itself, or common to a specific application container.
- The grantor has the necessary privileges to grant the specified role or privileges.  
For system roles and privileges, the grantor must have the `ADMIN OPTION` for the role or privilege being granted. For object privileges, the grantor must have the `GRANT OPTION` for the privilege being granted.
- The grant applies to all PDBs within the container (either CDB or application container) in which the grant occurred.  
The `GRANT` statement includes a `CONTAINER=ALL` clause specifying that the privilege or role is granted commonly.
- If a role is being granted, then it must be common, and if an object privilege is being granted, then the object on which the privilege is granted must be common.

#### Example 2-5 Granting a Privilege Commonly

In this example, both `SYSTEM` and `c##hr_admin` are common users. `SYSTEM` connects to the CDB root, and then grants the `CREATE ANY TABLE` privilege commonly to

c##hr\_admin. In this case, c##hr\_admin can now create a table in any PDB in the CDB.

```
CONNECT SYSTEM@root
Enter password: password
Connected.
```

```
GRANT CREATE ANY TABLE TO c##hr_admin CONTAINER=ALL;
```

 **See Also:**

*Oracle Database Security Guide* to learn how to grant common privileges

### 2.2.4.3.2 Roles and Privileges Granted Commonly

A common user account or role may be granted a *privilege* commonly (CONTAINER=ALL).

Within the context of either the CDB root or an application root, the privilege is granted to this common user account or role in all existing and future PDBs within the current container. For example, if SYSTEM connects to the CDB root and grants a SELECT ANY TABLE privilege commonly to CDB common user account c##dba, then the c##dba user has this privilege in all PDBs in the CDB. A role or privilege granted *commonly* cannot be revoked *locally*.

A user or role may receive a common role granted commonly. As mentioned in a footnote on [Table 2-5](#), a common role may receive a privilege granted locally. Thus, a common user can be granted a common role, and this role may contain locally granted privileges.

For example, the common role c##admin may be granted the SELECT ANY TABLE privilege that is local to hrpdb. Locally granted privileges in a common role apply *only* in the container in which the privilege was granted. Thus, the common user with the c##admin role does not have the right to exercise an hrpdb-contained privilege in salespdb or any PDB other than hrpdb.

 **See Also:**

*Oracle Database Security Guide* to learn how to grant roles and privileges in a CDB

### 2.2.4.4 Grants to PUBLIC in a CDB

In a CDB, PUBLIC is a common role. In a PDB, privileges granted locally to PUBLIC enable all local and common user account to exercise these privileges in this PDB only.

Every privilege and role granted to Oracle-supplied users and roles is granted commonly except for system privileges granted to `PUBLIC`, which are granted locally. This exception exists because you may want to revoke some grants included by default in Oracle Database, such as `EXECUTE` on the `SYS.UTL_FILE` package.

Assume that local user account `hr` exists in `hrpdb`. This user locally grants the `SELECT` privilege on `hr.employees` to `PUBLIC`. Common and local users in `hrpdb` may exercise the privilege granted to `PUBLIC`. User accounts in `salespdb` or any other PDB do not have the privilege to query `hr.employees` in `hrpdb`.

Privileges granted commonly to `PUBLIC` enable all local users to exercise the granted privilege in their respective PDBs and enable all common users to exercise this privilege in the PDBs to which they have access. Oracle recommends that users do not commonly grant privileges and roles to `PUBLIC`.

 **See Also:**

*Oracle Database Security Guide* to learn how the `PUBLIC` role works in a multitenant environment

## 2.2.4.5 Grants of Privileges and Roles: Scenario

In this scenario, `SYSTEM` creates common user `c##dba` and tries to give this user privileges to query a table in the `hr` schema in `hrpdb`.

The scenario shows how the `CONTAINER` clause affects grants of roles and privileges. The first column shows operations in `CDB$ROOT`. The second column shows operations in `hrpdb`.

**Table 2-6 Granting Roles and Privileges in a CDB**

t	Operations in CDB\$ROOT	Operations in hrpdb	Explanation
t1	SQL> CONNECT SYSTEM@root Enter password: ***** Connected.	n/a	Common user <code>SYSTEM</code> connects to the root container.
t2	SQL> CREATE USER c##dba IDENTIFIED BY <i>password</i> CONTAINER=ALL;	n/a	<code>SYSTEM</code> creates common user <code>c##dba</code> . The clause <code>CONTAINER=ALL</code> makes the user a common user.



**Table 2-6 (Cont.) Granting Roles and Privileges in a CDB**

t	Operations in CDB\$ROOT	Operations in hrpdb	Explanation
t3	<pre>SQL&gt; GRANT CREATE SESSION   TO c##dba;</pre>	n/a	SYSTEM grants the CREATE SESSION system privilege to c##dba. Because the clause CONTAINER=ALL is absent, this privilege is granted locally and thus applies <i>only</i> to the root, which is the current container.
t4	<pre>SQL&gt; CREATE ROLE c##admin   CONTAINER=ALL;</pre>	n/a	SYSTEM creates a common role named c##admin. The clause CONTAINER=ALL makes the role a common role.
t5	<pre>SQL&gt; GRANT SELECT ANY TABLE   TO c##admin; Grant succeeded.</pre>	n/a	SYSTEM grants the SELECT ANY TABLE privilege to the c##admin role. The absence of the CONTAINER=ALL clause makes the privilege local to the root. Thus, this common role contains a privilege that is exercisable only in the root.
t6	<pre>SQL&gt; GRANT c##admin TO c##dba; SQL&gt; EXIT;</pre>	n/a	SYSTEM grants the c##admin role to c##dba. Because the CONTAINER=ALL clause is absent, the role applies <i>only</i> to the current container, even though it is a common role. If c##dba connects to a PDB, then c##dba does not have this role.
t7	n/a	<pre>SQL&gt; CONNECT c##dba@hrpdb Enter password: ***** ERROR: ORA-01045: user c##dba lacks CREATE SESSION privilege; logon denied</pre>	c##dba fails to connect to hrpdb because the grant at t3 was local to the root.

**Table 2-6 (Cont.) Granting Roles and Privileges in a CDB**

t	Operations in CDB\$ROOT	Operations in hrpdb	Explanation
t8	n/a	<pre>SQL&gt; CONNECT SYSTEM@hrpdb Enter password: ***** Connected.</pre>	SYSTEM connects to hrpdb.
t9	n/a	<pre>SQL&gt; GRANT CONNECT, RESOURCE TO c##dba; Grant succeeded. SQL&gt; EXIT</pre>	SYSTEM grants the CONNECT and RESOURCE roles to common user c##dba. Because the clause CONTAINER=ALL is absent, the grant is local to hrpdb.
t10	n/a	<pre>SQL&gt; CONNECT c##dba@hrpdb Enter password: ***** Connected.</pre>	Common user c##dba connects to hrpdb.
t11	n/a	<pre>SQL&gt; SELECT COUNT(*) FROM hr.employees; select * from hr.employees           * ERROR at line 1: ORA-00942: table or view does not exist</pre>	The query of hr.employees still returns an error because c##dba does not have select privileges on tables in hrpdb. The SELECT ANY TABLE privilege granted locally at t5 is restricted to the root and thus does not apply to hrpdb.
t12	<pre>SQL&gt; CONNECT SYSTEM@root Enter password: ***** Connected.</pre>	n/a	Common user SYSTEM connects to the root container.
t13	<pre>SQL&gt; GRANT SELECT ANY TABLE TO c##admin CONTAINER=ALL; Grant succeeded.</pre>	n/a	SYSTEM grants the SELECT ANY TABLE privilege to the c##admin role. The presence of CONTAINER=ALL means the privilege is being granted commonly.

**Table 2-6 (Cont.) Granting Roles and Privileges in a CDB**

t	Operations in CDB\$ROOT	Operations in hrpdb	Explanation
t14	n/a	<pre>SQL&gt; SELECT COUNT(*) FROM hr.employees; select * from hr.employees *</pre> <p>ERROR at line 1: ORA-00942: table or view does not exist</p>	A query of hr.employees still returns an error. The reason is that at t6 the c##admin common role was granted to c##dba in the root only.
t15	<pre>SQL&gt; GRANT c##admin TO c##dba CONTAINER=ALL; Grant succeeded.</pre>	n/a	SYSTEM grants the common role named c##admin to c##dba, specifying CONTAINER=ALL. Now user c##dba has the role in all containers, not just the root.
t17	n/a	<pre>SQL&gt; SELECT COUNT(*) FROM hr.employees;  COUNT(*) ----- 107</pre>	The query succeeds.

 **See Also:**

*Oracle Database Security Guide* to learn how to manage common and local roles

## 2.2.5 Overview of Common and Local Objects in a CDB

A **common object** is defined in either the CDB root or an application root, and can be referenced using metadata links or object links. A local object is every object that is not a common object.

Database-supplied common objects are defined in CDB\$ROOT and cannot be changed. Oracle Database does not support creation of common objects in CDB\$ROOT.

You can create most schema objects—such as tables, views, PL/SQL and Java program units, sequences, and so on—as common objects in an application root. If the object exists in an application root, then it is called an **application common object**.

A local user can own a common object. Also, a common user can own a local object, but only when the object is not data-linked or metadata-linked, and is also neither a metadata link nor a data link.

 **See Also:**

- ["Application Common Objects"](#)
- ["About Application Common Objects"](#)
- *Oracle Database Security Guide* to learn more about privilege management for common objects

## 2.2.6 Overview of Common Audit Configurations

For both mixed mode and unified auditing, a **common audit configuration** is visible and enforced across all PDBs.

Audit configurations are either local or common. The scoping rules that apply to other local or common phenomena, such as users and roles, all apply to audit configurations.

 **Note:**

Audit initialization parameters exist at the CDB level and not in each PDB.

PDBs support the following auditing options:

- Object auditing

Object auditing refers to audit configurations for specific objects. Only common objects can be part of the common audit configuration. A local audit configuration cannot contain common objects.
- Audit policies

Audit policies can be local or common:

  - Local audit policies

A local audit policy applies to a single PDB. You can enforce local audit policies for local and common users in this PDB only. Attempts to enforce local audit policies across all containers result in an error.

In all cases, enforcing of a local audit policy is part of the local auditing framework.
  - Common audit policies

A common audit policy applies to all containers. This policy can only contain actions, system privileges, common roles, and common objects. You can apply a common audit policy only to common users. Attempts to enforce a common audit policy for a local user across all containers result in an error.

A common audit configuration is stored in the `SYS` schema of the root. A local audit configuration is stored in the `SYS` schema of the PDB to which it applies.

Audit trails are stored in the `SYS` or `AUDSYS` schemas of the relevant PDBs. Operating system and XML audit trails for PDBs are stored in subdirectories of the directory specified by the `AUDIT_FILE_DEST` initialization parameter.

#### See Also:

- *Oracle Database Concepts* for information about database auditing
- *Oracle Database Security Guide* to learn about common audit configurations

## 2.2.7 Overview of PDB Lockdown Profiles

A **PDB lockdown profile** is a named set of features that control operations available to users connected to a PDB. For example, a PDB lockdown profile can disable privileges that come with the `ALTER SYSTEM` statement.

A potential for elevation of privileges exists when PDBs share an identity. For example, identity can be shared at a network level, or when PDBs access common objects or connect through database links. To increase security, a CDB administrator may want to compartmentalize access, thereby restricting the operations that a user can perform in a PDB.

A use case might be the creation of lockdown profiles at high, medium, and low levels. The high level might greatly restrict access, whereas the low level might enable access.

You can restrict the following types of access:

- Network access  
For example, restrict access to `UTL_HTTP` or `UTL_MAIL`.
- Common user and common object access  
For example, restrict operations in which a local user in a PDB can proxy through a common user or access objects in a common schema.
- Operating system access  
For example, restrict access to the `UTL_FILE` or `DBMS_FILE_TRANSFER` PL/SQL packages.
- Connections  
For example, you can restrict common users from connecting to the PDB or you can restrict a local user who has the `SYSOPER` administrative privilege from connecting to a PDB that is open in restricted mode.
- Administrative features  
For example, you can restrict the use of `ALTER SYSTEM`, `ALTER SESSION`, and `ALTER DATABASE`.
- Database options

For example, you can use lockdown profiles to disable access to database options such as Oracle Partitioning or Oracle Database Advanced Queuing.

When logged in to the CDB root or application root, create a lockdown profile by issuing the `CREATE LOCKDOWN PROFILE` statement, which supports the following optional clauses:

- `FROM static_base_profile` creates a new lockdown profile by using the values from an existing profile. Any subsequent changes to the existing profile will not affect the new profile.
- `INCLUDING dynamic_base_profile` creates a new lockdown profile by using the values from an existing profile, except that this new lockdown profile inherits the `DISABLE STATEMENT` rules that comprise the base profile, and any subsequent changes to the base profile.

The user issuing the statement must have the `CREATE LOCKDOWN PROFILE` system privilege in the current container. You can add and remove restrictions with the `ALTER LOCKDOWN PROFILE` statement. The user must issue the `ALTER` statement in the CDB root or application root and must have the `ALTER LOCKDOWN PROFILE` system privilege in the current container.

Specify a lockdown profile by using the `PDB_LOCKDOWN` initialization parameter. This parameter determines whether the PDB lockdown profile applies to a given PDB. You can set this parameter at the following levels:

- **PDB**  
The profile applies only to the PDB in which it is set.
- **Application container**  
The profile applies to all application PDBs in the application container. The value can be modified only by an application common user who has application common `SYSDBA` or common `ALTER SYSTEM` privileges or a CDB common user who has common `SYSDBA` or common `ALTER SYSTEM` privileges.
- **CDB**  
The profile applies to all PDBs. A common user who has common `SYSDBA` or common `ALTER SYSTEM` privileges can override a CDB-wide setting for a specific PDB.

If the `PDB_LOCKDOWN` parameter in a PDB is set to the name of a lockdown profile different from the container for this PDB (CDB or application container), then a set of rules govern the interaction between restrictions.

### Example 2-6 Creating a PDB Lockdown Profile

In this example, you connect to the CDB root as a common user with the `CREATE LOCKDOWN PROFILE` privilege. You create a profile called `medium` that disables all `ALTER SYSTEM` statements except for `ALTER SYSTEM FLUSH SHARED POOL`:

```
CREATE LOCKDOWN PROFILE medium;  
ALTER LOCKDOWN PROFILE medium DISABLE STATEMENT=('ALTER SYSTEM');  
ALTER LOCKDOWN PROFILE medium ENABLE STATEMENT=('ALTER SYSTEM')  
CLAUSE=('FLUSH SHARED POOL');
```

You can connect as the same common user to each PDB that requires this profile, and then use `ALTER SYSTEM` to set the `PDB_LOCKDOWN` initialization parameter to `medium`. For example, you could set `PDB_LOCKDOWN` to `medium` for `hrpdb`, but not `salespdb`.

The following example creates a `medium2` profile from `medium`:

```
CREATE LOCKDOWN PROFILE medium2 FROM medium;
```

 **Note:**

- ["About Restricting PDB Users for Enhanced Security"](#) to learn more about PDB lockdown profiles
- *Oracle Database Security Guide* to learn how to create, enable, and drop PDB lockdown profiles

## 2.3 Overview of Applications in an Application Container

Within an application container, an **application** is the named, versioned set of common data and metadata stored in the application root.

In this context of an application container, the term “application” means “master application definition.” For example, the application might include definitions of tables, views, and packages.

This section contains the following topics:

- [About Application Containers](#)  
An **application container** is an optional, user-created CDB component that stores data and metadata for one or more application back ends. A CDB includes zero or more application containers.
- [Application Common Objects](#)  
An **application common object** is a common object created within an application in an application root. Common objects are either data-linked or metadata-linked.
- [Application Maintenance](#)  
In this context, **application maintenance** refers to installing, uninstalling, upgrading, or patching an application.
- [Migration of an Existing Application](#)  
You can migrate an application that is installed in a PDB to either an application root or to an application PDB.
- [Implicitly Created Applications](#)  
In addition to user-created applications, application containers can also contain implicitly created applications.
- [Application Synchronization](#)  
Within an application PDB, synchronization is the user-initiated update of the application to the latest version and patch in the application root.

- [Container Maps](#)  
A **container map** enables a session connected to application root to issue SQL statements that are routed to the appropriate PDB, depending on the value of a predicate used in the SQL statement.

 **See Also:**

- ["Overview of Common and Local Objects in a CDB"](#) to learn about application common objects
- ["Creating and Removing Application Containers and Seeds"](#)
- ["Administering Application Containers"](#)

## 2.3.1 About Application Containers

An **application container** is an optional, user-created CDB component that stores data and metadata for one or more application back ends. A CDB includes zero or more application containers.

For example, you might create multiple sales-related PDBs within one application container, with these PDBs sharing an application back end that consists of a set of common tables and table definitions. You might store multiple HR-related PDBs within a separate application container, with their own common tables and table definitions.

The `CREATE PLUGGABLE DATABASE` statement with the `AS APPLICATION CONTAINER` clause creates the application root of the application container, and thus implicitly creates the application container itself. When you first create the application container, it contains no PDBs. To create application PDBs, you must connect to the application root, and then execute the `CREATE PLUGGABLE DATABASE` statement.

In the `CREATE PLUGGABLE DATABASE` statement, you must specify a container name (which is the same as the application root name), for example, `saas_sales_ac`. The application container name must be unique within the CDB, and within the scope of all the CDBs whose instances are reached through a specific listener. Every application container has a default service with the same name as the application container.

- [Purpose of Application Containers](#)  
In some ways, an application container functions as an application-specific CDB *within* a CDB. An application container, like the CDB itself, can include multiple PDBs, and enables these PDBs to share metadata and data.
- [Application Root](#)  
An application container has exactly one **application root**, which is the parent of the application PDBs in the container.
- [Application PDBs](#)  
An **application PDB** is a PDB that resides in an application container. Every PDB in a CDB resides in either zero or one application containers.
- [Application Seed](#)  
An **application seed** is an optional, user-created PDB within an application container. An application container has either zero or one application seed.



 **See Also:**

- ["Overview of Applications in an Application Container"](#)
- ["Creating and Removing Application Containers and Seeds"](#)
- ["Administering Application Containers"](#)

### 2.3.1.1 Purpose of Application Containers

In some ways, an application container functions as an application-specific CDB *within* a CDB. An application container, like the CDB itself, can include multiple PDBs, and enables these PDBs to share metadata and data.

The application root enables application PDBs to share an [application](#), which in this context means a named, versioned set of common metadata and data. A typical application installs application common users, metadata-linked common objects, and data-linked common objects.

This section contains the following topics:

- [Key Benefits of Application Containers](#)  
Application containers provide several benefits over storing each application in a separate PDB.
- [Application Container Use Case: SaaS](#)  
A SaaS deployment can use multiple application PDBs, each for a separate customer, that share metadata and data.
- [Application Containers Use Case: Logical Data Warehouse](#)  
A customer can use multiple application PDBs to address data sovereignty issues.

#### 2.3.1.1.1 Key Benefits of Application Containers

Application containers provide several benefits over storing each application in a separate PDB.

- The application root stores metadata and data that all application PDBs can share. For example, all application PDBs can share data in a central table, such as a table listed default application roles. Also, all PDBs can share a table definition to which they add PDB-specific rows.
- You maintain your master application definition in the application root, instead of maintaining a separate copy in each PDB.

If you upgrade the application in the application root, then the changes are automatically propagated to all application PDBs. The application back end might contain the [data-linked common object](#) `app_roles`, which is a table that list default roles: `admin`, `manager`, `sales_rep`, and so on. A user connected to any application PDB can query this table.

- An application container can include an application seed, application PDBs, and proxy PDBs (which refer to PDBs in other CDBs).
- You can rapidly create new application PDBs from the [application seed](#).
- You can query views that report on all PDBs in the application container.

- While connected to the application root, you can use the `CONTAINERS` function to perform DML on objects in multiple PDBs.  
For example, if the `products` table exists in every application PDB, then you can connect to the application root and query the products in all application PDBs using a single `SELECT` statement.
- You can unplug a PDB from an application root, and then plug it in to an application root in a higher Oracle database release. Thus, PDBs are useful in an Oracle database upgrade.



**See Also:**

["Overview of Applications in an Application Container"](#)

### 2.3.1.1.2 Application Container Use Case: SaaS

A SaaS deployment can use multiple application PDBs, each for a separate customer, that share metadata and data.

In a pure SaaS environment, the master application definition resides in the application root, but the customer-specific data resides in its own application PDB. For example, `sales_app` is the application model in the application root. The application PDB named `cust1_pdb` contains sales data only for customer 1, whereas the application PDB named `cust2_pdb` contains sales data only for customer 2. Plugging, unplugging, cloning, and other PDB-level operations are available for individual customer PDBs.

Figure 2-8 SaaS Use Case

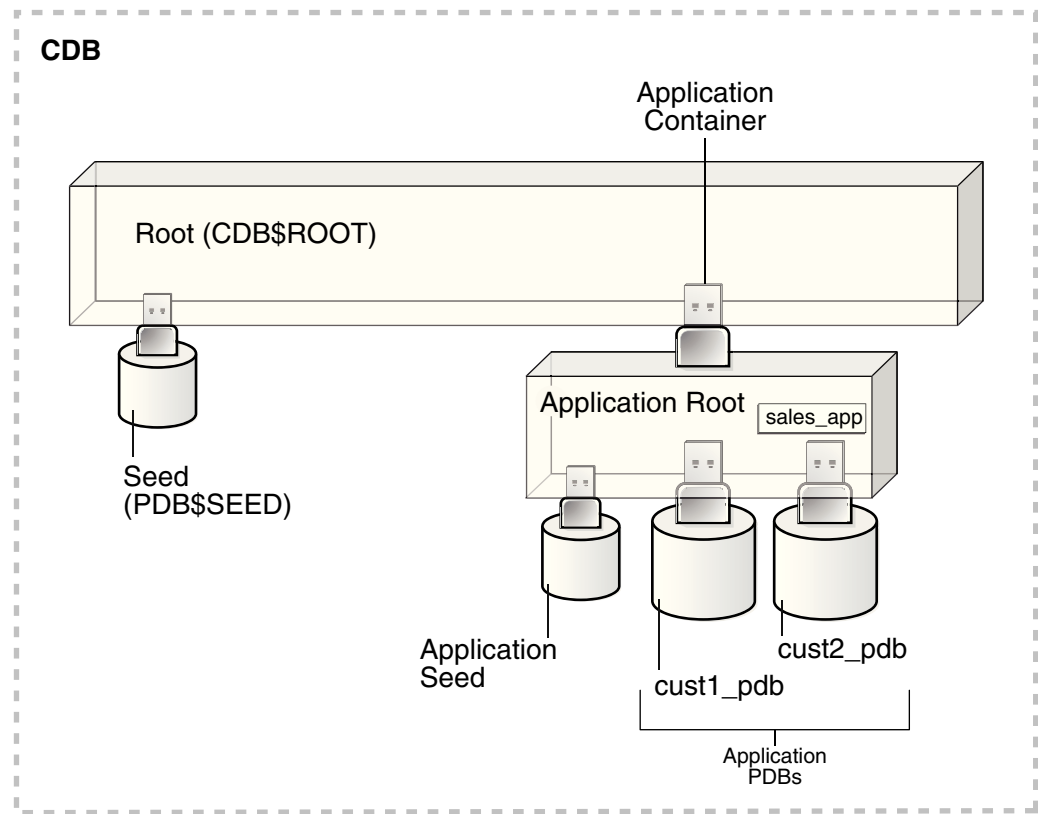

A pure SaaS configuration provides the following benefits:

- Performance
- Security
- Support for multiple customers

The data for each customer resides in its own container, but is consolidated so that you can manage many customers collectively. This model extends the economies of scale of managing many as one to the application administrator, not only the DBA.

### 2.3.1.1.3 Application Containers Use Case: Logical Data Warehouse

A customer can use multiple application PDBs to address data sovereignty issues.

In a sample use case, a company puts data specific to each financial quarter in a separate PDB. For example, the application container named `sales_ac` includes `q1_2016_pdb`, `q2_2016_pdb`, `q3_2016_pdb`, and `q4_2016_pdb`. You define each transaction in the PDB corresponding to the associated quarter. To generate a report that aggregates performance across a year, you aggregate across the four PDBs using the `CONTAINERS()` clause.

Benefits of this logical warehouse design include:

- ETL for data specific to a single PDB does not affect the other PDBs.

- Execution plans are more efficient because they are based on actual data distribution.

### 2.3.1.2 Application Root

An application container has exactly one **application root**, which is the parent of the application PDBs in the container.

The property of being an application root is established at creation time, and cannot be changed. The only container to which an application root belongs is the CDB root. An application root is like the CDB root in some ways, and like a PDB in other ways:

- Like the CDB root, an application root serves as parent container to the PDBs plugged into it. When connected to the application root, you can manage common users and privileges, create application PDBs, switch containers, and issue DDL that applies to all PDBs in the application container.
- Like a PDB, you create an application root with the `CREATE PLUGGABLE DATABASE` statement, alter it with `ALTER PLUGGABLE DATABASE`, and change its availability with `STARTUP` and `SHUTDOWN`. You can use DDL to plug, unplug, and drop application roots. The application root has its own service name, and users can connect to the application root in the same way that they connect to a PDB.

An application root differs from both the CDB root and standard PDB because it can store *user-created* common objects, which are called **application common objects**. Application common objects are accessible to the application PDBs plugged in to the application root. Application common objects are not visible to the CDB root, other application roots, or PDBs that do not belong to the application root.



#### See Also:

- ["Creating and Removing Application Containers and Seeds"](#)
- ["Administering Application Containers"](#)

#### Example 2-7 Creating an Application Root

In this example, you log in to the CDB root as administrative common user `c##system`. You create an application container named `saas_sales_ac`, and then open the application root, which has the same name as the container.

```
-- Create the application container called saas_sales_ac
CREATE PLUGGABLE DATABASE saas_sales_ac AS APPLICATION CONTAINER
  ADMIN USER saas_sales_ac_adm IDENTIFIED BY manager;

-- Open the application root
ALTER PLUGGABLE DATABASE saas_sales_ac OPEN;
```

You set the current container to `saas_sales_ac`, and then verify that this container is the application root:

```
-- Set the current container to saas_sales_ac
ALTER SESSION SET CONTAINER = saas_sales_ac;

COL NAME FORMAT a15
COL ROOT FORMAT a4
SELECT CON_ID, NAME, APPLICATION_ROOT AS ROOT,
       APPLICATION_PDB AS PDB,
FROM   V$CONTAINERS;
```

CON_ID	NAME	ROOT	PDB
3	SAAS_SALES_AC	YES	NO

### 2.3.1.3 Application PDBs

An **application PDB** is a PDB that resides in an application container. Every PDB in a CDB resides in either zero or one application containers.

For example, the `saas_sales_ac` application container might support multiple customers, with each customer application storing its data in a separate PDB. The application PDBs `cust1_sales_pdb` and `cust2_sales_pdb` might reside in `saas_sales_ac`, in which case they belong to no other application container (although as PDBs they necessarily belong also to the CDB root).

Create an application PDB by executing `CREATE PLUGGABLE DATABASE` while connected to the application root. You can either create the application PDB from a seed, or clone a PDB or plug in an unplugged PDB. Like a PDB that is plugged in to CDB root, you can clone, unplug, or drop an application PDB. However, an application PDB must always belong to an application root.



#### See Also:

["Creating and Removing Application Containers and Seeds"](#)

### 2.3.1.4 Application Seed

An **application seed** is an optional, user-created PDB within an application container. An application container has either zero or one application seed.

An application seed enables you to create application PDBs quickly. It serves the same role within the application container as `PDB$SEED` serves within the CDB itself.

The application seed name is always `application_container_name$SEED`, where `application_container_name` is the name of the application container. For example, use the `CREATE PDB ... AS SEED` statement to create `saas_sales_ac$SEED` in the `saas_sales_ac` application container.

**See Also:**

["Creating and Removing Application Seeds"](#)

## 2.3.2 Application Common Objects

An **application common object** is a common object created within an application in an application root. Common objects are either data-linked or metadata-linked.

For a **data-linked common object**, application PDBs share a single set of data. For example, an application for the `saas_sales_ac` application container is named `saas_sales_app`, has version 1.0, and includes a data-linked `usa_zipcodes` table. In this case, the rows are stored once in the table in the application root, but are visible in all application PDBs.

For a **metadata-linked common object**, application PDBs share only the metadata, but contain different sets of data. For example, a metadata-linked `products` table has the same definition in every application PDB, but the rows themselves are specific to the PDB. The application PDB named `cust1pdb` might have a `products` table that contains books, whereas the application PDB named `cust2pdb` might have a `products` table that contains auto parts.

This section contains the following topics:

- [Creation of Application Common Objects](#)  
To create common objects, connect to an application root, and then execute a `CREATE` statement that specifies a sharing attribute.
- [Metadata-Linked Application Common Objects](#)  
A **metadata link** is a dictionary object that supports referring to, and granting privileges on, common metadata shared by all PDBs in the application container.
- [Data-Linked Application Common Objects](#)  
A **data-linked object** is an object whose metadata and data reside in an application root, and are accessible from all application PDBs in this application container.
- [Extended Data-Linked Application Objects](#)  
An **extended data-linked object** is a hybrid of a data-linked object and metadata-linked object.

**See Also:**

- ["Overview of Common and Local Objects in a CDB"](#) to learn about common objects
- ["About Application Common Objects"](#)

### 2.3.2.1 Creation of Application Common Objects

To create common objects, connect to an application root, and then execute a `CREATE` statement that specifies a sharing attribute.

You can only create or change application common objects as part of an application installation, upgrade, or patch. You can specify sharing in the following ways:

- `DEFAULT_SHARING` initialization parameter  
The setting is the default sharing attribute for all database objects of a supported type created in the root.
- `SHARING` clause  
You specify this clause in the `CREATE` statement itself. When a `SHARING` clause is included in a SQL statement, it takes precedence over the value specified in the `DEFAULT_SHARING` initialization parameter. Possible values are `METADATA`, `DATA`, `EXTENDED DATA`, and `NONE`.

The following table shows the types of application common objects, and where the data and metadata is stored.

**Table 2-7 Application Common Objects**

Object Type	SHARING Value	Metadata Storage	Data Storage
Data-Linked	DATA	Application root	Application root
Extended Data-Linked	EXTENDED DATA	Application root	Application root and application PDB
Metadata-Linked	METADATA	Application root	Application PDB

#### See Also:

- ["Creating Application Common Objects"](#)
- *Oracle Database Security Guide* to learn how to manage privileges for common objects

### 2.3.2.2 Metadata-Linked Application Common Objects

A **metadata link** is a dictionary object that supports referring to, and granting privileges on, common metadata shared by all PDBs in the application container.

Specifying the `METADATA` value in either the `SHARING` clause or the `DEFAULT_SHARING` initialization parameter specifies a link to an object's metadata, called a [metadata-linked common object](#). The metadata for the object is stored once in the application root.

Tables, views, and code objects (such as PL/SQL procedures) can share metadata. In this context, "metadata" includes column definitions, constraints, triggers, and code. For example, if `sales_mlt` is a metadata-linked common table, then all application PDBs access the *same* definition of this table, which is stored in the application root,

by means of a metadata link. The rows in `sales_mlt` are different in every application PDB, but the column definitions are the same.

Typically, most objects in an application will be metadata-linked. Thus, you need only maintain one master application definition. This approach centralizes management of the application in multiple application PDBs.

### Example 2-8 Creating a Metadata-Linked Common Object

In this example, the `SYSTEM` user logs in to the `saas_sales_ac` application container. `SYSTEM` installs an application named `saas_sales_app` at version 1.0 (see "[Application Maintenance](#)"). This application creates a common user account named `saas_sales_adm`. The schema contains a metadata-linked common table named `sales_mlt`.

```
-- Begin the install of saas_sales_app
ALTER PLUGGABLE DATABASE APPLICATION saas_sales_app BEGIN INSTALL '1.0';

-- Create the tablespace for the app
CREATE TABLESPACE saas_sales_tbs DATAFILE SIZE 100M AUTOEXTEND ON NEXT 10M
MAXSIZE 200M;

-- Create the user account saas_sales_adm, which will own the app
CREATE USER saas_sales_adm IDENTIFIED BY ***** CONTAINER=ALL;

-- Grant necessary privileges to this user account
GRANT CREATE SESSION, DBA TO saas_sales_adm;

-- Makes the tablespace that you just created the default for
saas_sales_adm
ALTER USER saas_sales_adm DEFAULT TABLESPACE saas_sales_tbs;

-- Now connect as the application owner
CONNECT saas_sales_adm/*****@saas_sales_ac

-- Create a metadata-linked table
CREATE TABLE saas_sales_adm.sales_mlt SHARING=METADATA
(YEAR      NUMBER(4),
 REGION    VARCHAR2(10),
 QUARTER   VARCHAR2(4),
 REVENUE   NUMBER);

-- End the application installation
ALTER PLUGGABLE DATABASE APPLICATION saas_sales_app END INSTALL '1.0';
```

You can use the `ALTER PLUGGABLE DATABASE APPLICATION ... SYNC` statement to synchronize the application PDBs to use the same master application definition. In this way, every application PDB has a metadata link to the `saas_sales_adm.sales_mlt` common table. The middle-tier code that updates `sales_mlt` within the PDB named `cust1_pdb` adds rows to this table in `cust1_pdb`, whereas the middle-tier code that updates `sales_mlt` in `cust2_pdb` adds rows to the copy of this table in `cust2_pdb`. Only the table metadata, which is stored in the application root, is shared.



 **Note:**

- ["About Application Common Objects"](#)
  - *Oracle Database Security Guide* to learn more about how commonly granted object privileges work
- 
- [Metadata Links](#)  
For metadata-linked application common objects, the metadata for the object is stored once in the application root. A metadata link is a dictionary object whose object type is the same as the metadata it is sharing.

### 2.3.2.2.1 Metadata Links

For metadata-linked application common objects, the metadata for the object is stored once in the application root. A metadata link is a dictionary object whose object type is the same as the metadata it is sharing.

The description of a metadata link is stored in the data dictionary of the PDB in which it is created. A metadata link must be owned by an application common user. You can only use metadata links to share metadata of common objects owned by their creator in the CDB root or an application root.

Unlike a data link, a metadata link depends *only* on common data. For example, if an application contains the local tables `dow_close_lt` and `nasdaq_close_lt` in the application root, then a common user cannot create metadata links to these objects. However, an application common table named `sales_mlt` may be metadata-linked.

If a privileged common user changes the metadata for `sales_mlt`, for example, adds a column to the table, then this change propagates to the metadata links. Application PDB users may not change the metadata in the metadata link. For example, a DBA who manages the application PDB named `cust1_pdb` cannot add a column to `sales_mlt` in this PDB only: such metadata changes can be made only in the application root.

 **See Also:**

["About Application Common Objects"](#)

### 2.3.2.3 Data-Linked Application Common Objects

A **data-linked object** is an object whose metadata and data reside in an application root, and are accessible from all application PDBs in this application container.

Specifying the `DATA` value in either the `SHARING` clause or the `DEFAULT_SHARING` initialization parameter specifies a link to a common object, called a [data-linked common object](#). Dimension tables in a data warehouse are often good candidates for data-linked common tables.

A data link is a dictionary object that functions much like a synonym. For example, if `countries` is an application common table, then all application PDBs access the *same*

copy of this table by means of a data link. If a row is added to this table, then this row is visible in all application PDBs.

A data link must be owned by an application common user. The link inherits the object type from the object to which it is pointing. The description of a data link is stored in the dictionary of the PDB in which it is created. For example, if an application container contains 10 application PDBs, and if every PDB contains a link to the `countries` application common table, then all 10 PDBs contain dictionary definitions for this link.

### Example 2-9 Creating a Data-Linked Object

In this example, `SYSTEM` connects to the `saas_sales_ac` application container. `SYSTEM` upgrades the application named `saas_sales_app` from version 1.0 to 2.0. This application upgrade logs in to the container as common user `saas_sales_adm`, creates a data-linked table named `countries_dlt`, and then inserts rows into it.

```
-- Begin an upgrade of the application
ALTER PLUGGABLE DATABASE APPLICATION saas_sales_app BEGIN UPGRADE '1.0' to
'2.0';

-- Connect as application owner to application root
CONNECT saas_sales_adm/manager@saas_sales_ac

-- Create data-linked table named countries_dlt
CREATE TABLE countries_dlt SHARING=DATA
(country_id  NUMBER,
 country_name VARCHAR2(20));

-- Insert records into countries_dlt
INSERT INTO countries_dlt VALUES(1, 'USA');
INSERT INTO countries_dlt VALUES(44, 'UK');
INSERT INTO countries_dlt VALUES(86, 'China');
INSERT INTO countries_dlt VALUES(91, 'India');

-- End application upgrade
ALTER PLUGGABLE DATABASE APPLICATION saas_sales_app END UPGRADE TO '2.0';
```

Use the `ALTER PLUGGABLE DATABASE APPLICATION ... SYNC` statement to synchronize application PDBs with the application root (see "[Application Synchronization](#)"). In this way, every synchronized application PDB has a data link to the `saas_sales_adm.countries_dlt` data-linked table.



#### Note:

"[About Application Common Objects](#)"

## 2.3.2.4 Extended Data-Linked Application Objects

An **extended data-linked object** is a hybrid of a data-linked object and metadata-linked object.

In an extended data-linked object, the data stored in the application root is common to all application PDBs, and all PDBs can access this data. However, each application

PDB can create its own, PDB-specific data while sharing the common data in application root. Thus, the PDBs supplement the common data with their own data.

For example, a sales application might support several application PDBs. All application PDBs need the postal codes for the United States. In this case, you might create a `zipcodes_edt` extended data-linked table in the application root. The application root stores the United States postal codes, so all application PDBs can access them. However, one application PDB requires the postal codes for the United States and Canada. This application PDB can store the postal codes for Canada in the extended data-linked object in the application PDB instead of in the application root.

Create an extended data-linked object by connecting to the application root and specifying the `SHARING=EXTENDED DATA` keyword in the `CREATE` statement.

### Example 2-10 Creating an Extended-Data Object

In this example, `SYSTEM` connects to the `saas_sales_ac` application container, and then upgrades the application named `saas_sales_app` (created in "Example 2-8") from version 2.0 to 3.0. This application logs in to the container as common user `saas_sales_adm`, creates an extended data-linked table named `zipcodes_edt`, and then inserts rows into it.

```
-- Begin an upgrade of the app
ALTER PLUGGABLE DATABASE APPLICATION saas_sales_app BEGIN UPGRADE '2.0' to
'3.0';

-- Connect as app owner to app root
CONNECT saas_sales_adm/manager@saas_sales_ac

-- Create a common-data table named zipcodes_edt
CREATE TABLE zipcodes_edt SHARING=EXTENDED DATA
(code          VARCHAR2(5),
 country_id   NUMBER,
 region      VARCHAR2(10));

-- Load rows into zipcodes_edt
INSERT INTO zipcodes_edt VALUES ('08820','1','East');
INSERT INTO zipcodes_edt VALUES ('10005','1','East');
INSERT INTO zipcodes_edt VALUES ('44332','1','North');
INSERT INTO zipcodes_edt VALUES ('94065','1','West');
INSERT INTO zipcodes_edt VALUES ('73301','1','South');
COMMIT;

-- End app upgrade
ALTER PLUGGABLE DATABASE APPLICATION saas_sales_app END UPGRADE TO '3.0';
```

Use the `ALTER PLUGGABLE DATABASE APPLICATION ... SYNC` statement to synchronize application PDBs with the application (see "[Application Synchronization](#)"). In this way, every synchronized application PDB has a data link to the `saas_sales_adm.zipcodes_edt` data-linked table. Applications that connect to these PDBs can see the postal codes that were inserted into `zipcodes_edt` during the application upgrade, but can also insert their own postal codes into this table.

**Note:**

["About Application Common Objects"](#)

## 2.3.3 Application Maintenance

In this context, **application maintenance** refers to installing, uninstalling, upgrading, or patching an application.

An application must have a name and version number. This combination of properties determines which maintenance operations you can perform. In all maintenance operations, you perform the following steps:

1. Begin by executing the `ALTER PLUGGABLE DATABASE ... APPLICATION` statement with the `BEGIN INSTALL`, `BEGIN UPGRADE`, or `BEGIN PATCH` clauses.
2. Execute statements to alter the application.
3. End by executing the `ALTER PLUGGABLE DATABASE ... APPLICATION` statement with the `END INSTALL`, `END UPGRADE`, or `END PATCH` clauses.

As the application evolves, the application container maintains all versions and patch changes.

This section contains the following topics:

**Note:**

["About Application Management"](#)

- [About Application Maintenance](#)  
Perform application installation, upgrade, and patching operations using an `ALTER PLUGGABLE DATABASE APPLICATION` statement.
- [Application Installation](#)  
An **application installation** is the initial creation of a master application definition. A typical installation creates user accounts, tables, and PL/SQL packages.
- [Application Upgrade](#)  
An **application upgrade** is a major change to an installed application.
- [Application Patch](#)  
An **application patch** is a minor change to an application.

### 2.3.3.1 About Application Maintenance

Perform application installation, upgrade, and patching operations using an `ALTER PLUGGABLE DATABASE APPLICATION` statement.

The basic steps for application maintenance are as follows:

1. Log in to the application root.

2. Begin the operation with an `ALTER PLUGGABLE DATABASE APPLICATION ... BEGIN` statement in the application root.
3. Execute the application maintenance statements.
4. End the operation with an `ALTER PLUGGABLE DATABASE APPLICATION ... END` statement.

Perform the maintenance using scripts, SQL statements, or GUI tools.



#### See Also:

["About Application Management"](#)

### 2.3.3.2 Application Installation

An **application installation** is the initial creation of a master application definition. A typical installation creates user accounts, tables, and PL/SQL packages.

To install the application, specify the following in the `ALTER PLUGGABLE DATABASE APPLICATION` statement:

- Name of the application
- Application version number

#### Example 2-11 Installing an Application

This example assumes that you are logged in to the application container named `saas_sales_ac` as. The example installs an application named `saas_sales_app` at version 1.0. Note that you specify the version with a string rather than a number. The application creates an application common user named `saas_sales_adm`, grants necessary privileges, and then connects to the application root as this user. This user creates a metadata-linked table named `sales_mlt`.

```
-- Begin the install of saas_sales_app
ALTER PLUGGABLE DATABASE APPLICATION saas_sales_app BEGIN INSTALL '1.0';

-- Create the tablespace for the app
CREATE TABLESPACE saas_sales_tbs DATAFILE SIZE 100M AUTOEXTEND ON NEXT 10M
MAXSIZE 200M;

-- Create the user account saas_sales_adm, which will own the application
CREATE USER saas_sales_adm IDENTIFIED BY manager CONTAINER=ALL;

-- Grant necessary privileges to this user account
GRANT CREATE SESSION, DBA TO saas_sales_adm;

-- Make the tablespace that you just created the default for saas_sales_adm
ALTER USER saas_sales_adm DEFAULT TABLESPACE saas_sales_tbs;

-- Now connect as the application owner
CONNECT saas_sales_adm/manager@saas_sales_ac

-- Create a metadata-linked table
```

```

CREATE TABLE saas_sales_adm.sales_mlt SHARING=METADATA
(YEAR          NUMBER(4),
 REGION        VARCHAR2(10),
 QUARTER       VARCHAR2(4),
 REVENUE       NUMBER);

-- End the application installation
ALTER PLUGGABLE DATABASE APPLICATION saas_sales_app END INSTALL '1.0';

```

**PDB synchronization** is the user-initiated update of an application PDB with the application in the application root. After you synchronize the application PDBs with the `saas_sales_app` application, each application PDB will contain an empty table named `products_mlt`. An application can connect to an application PDB, and then insert PDB-specific rows into this table.

#### See Also:

- ["Application Synchronization"](#)
- ["Installing an Application in an Application Container with Automated Propagation"](#)

### 2.3.3.3 Application Upgrade

An **application upgrade** is a major change to an installed application.

Typically, an upgrade changes the physical architecture of the application. For example, an upgrade might add new user accounts, tables, and packages, or alter the definitions of existing objects.

To upgrade the application, you must specify the following in the `ALTER PLUGGABLE DATABASE APPLICATION` statement:

- Name of the application
- Old application version number
- New application version number

#### **Example 2-12 Upgrading an Application Using the Automated Technique**

In this example, you connect to the application root as an administrator, and then upgrade the application `saas_sales_app` from version 1.0 to version 2.0. The upgrade creates a data-linked table named `countries_dlt`, and then adds rows to it. It also creates an extended data-linked table named `zipcodes_edt`, and then adds rows to it.

```

-- Begin an upgrade of the app
ALTER PLUGGABLE DATABASE APPLICATION saas_sales_app BEGIN UPGRADE '1.0' to
'2.0';

-- Connect as app owner to app root
CONNECT saas_sales_adm/manager@saas_sales_ac

-- Create data-linked table named countries_dlt

```

```
CREATE TABLE countries_dlt SHARING=DATA
(country_id NUMBER,
 country_name VARCHAR2(20));

-- Insert records into countries_dlt
INSERT INTO countries_dlt VALUES(1, 'USA');
INSERT INTO countries_dlt VALUES(44, 'UK');
INSERT INTO countries_dlt VALUES(86, 'China');
INSERT INTO countries_dlt VALUES(91, 'India');

-- Create an extended data-linked table named zipcodes_edt
CREATE TABLE zipcodes_edt SHARING=EXTENDED DATA
(code VARCHAR2(5),
 country_id NUMBER,
 region VARCHAR2(10));

-- Load rows into zipcodes_edt
INSERT INTO zipcodes_edt VALUES ('08820', '1', 'East');
INSERT INTO zipcodes_edt VALUES ('10005', '1', 'East');
INSERT INTO zipcodes_edt VALUES ('44332', '1', 'North');
INSERT INTO zipcodes_edt VALUES ('94065', '1', 'West');
INSERT INTO zipcodes_edt VALUES ('73301', '1', 'South');
COMMIT;

-- End app upgrade
ALTER PLUGGABLE DATABASE APPLICATION saas_sales_app END UPGRADE TO '2.0';
```

This section contains the following topics:

- [How an Application Upgrade Works](#)  
During an application upgrade, the application remains available. To make this availability possible, Oracle Database clones the application root.
- [Applications at Different Versions](#)  
Different application PDBs might use different versions of the application.



#### See Also:

["Upgrading Applications in an Application Container"](#)

### 2.3.3.3.1 How an Application Upgrade Works

During an application upgrade, the application remains available. To make this availability possible, Oracle Database clones the application root.

The following figure gives an overview of the application upgrade process.

Figure 2-9 Application Upgrade

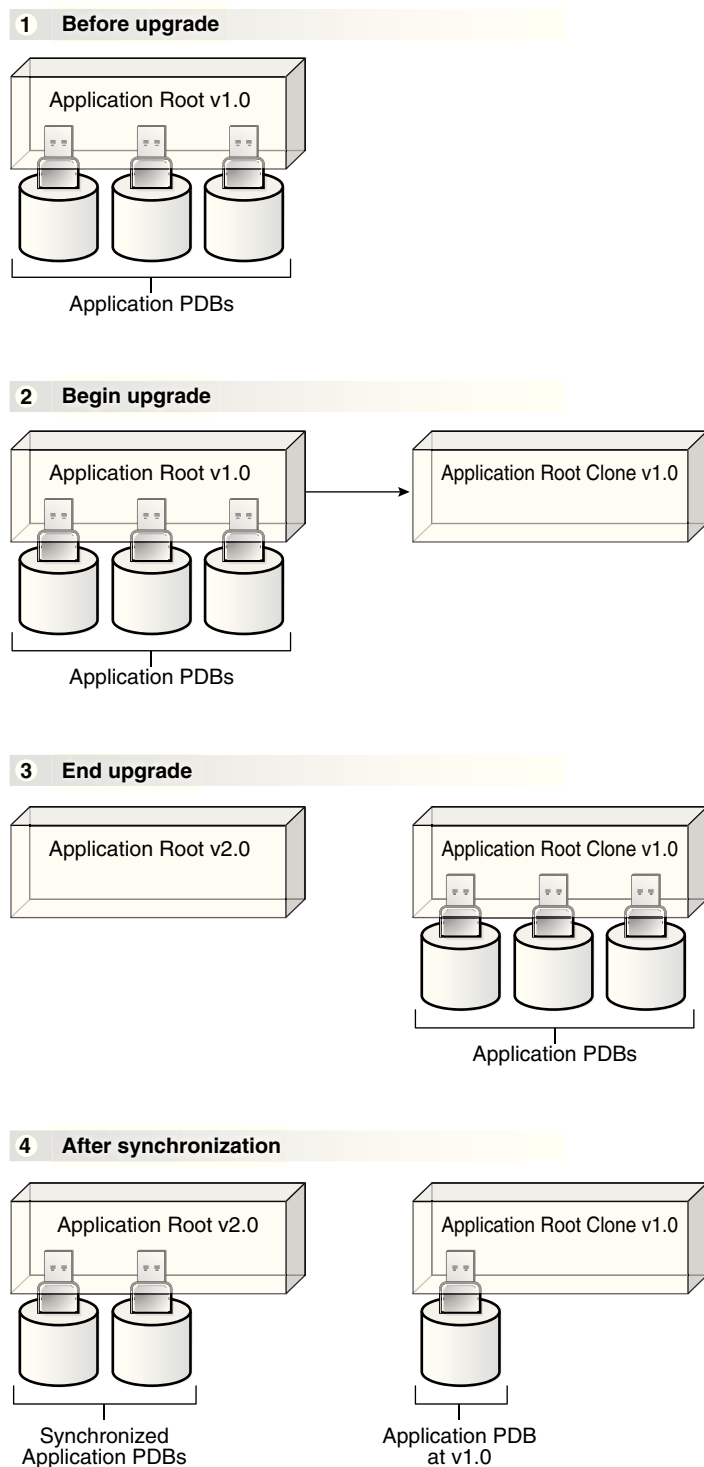

An upgrade occurs as follows:

1. In the initial state, the application root has an application in a specific version.



2. The user executes the `ALTER PLUGGABLE DATABASE APPLICATION BEGIN UPGRADE` statement, and then issues the application upgrade statements.

During the upgrade, the database automatically does the following:

- Clones the application root  
For example, if the `saas_sales_app` application is at version 1.0 in the application root, then the clone is also at version 1.0
- Points the application PDBs to the application root clone  
The clone is in read-only mode. The application remains available to the application PDBs.

3. The user executes the `ALTER PLUGGABLE DATABASE APPLICATION END UPGRADE` statement.

At this stage, the application PDBs are still pointing to the application root clone, and the original application root is at a new version. For example, if the `saas_sales_app` application is at version 1.0 in the application root, then the upgrade might bring it to version 2.0. The application root clone, however, remains at version 1.0.

4. Optionally, the user synchronizes the application PDBs with the upgraded application root by issuing `ALTER PLUGGABLE DATABASE APPLICATION` statement with the `SYNC` clause.

For example, after the synchronization, some application PDBs are plugged in to the application root at version 2.0. However, the application root clone continues to support application PDBs that must stay on version 1.0, or any new application PDBs that are plugged in to the application root at version 1.0.

#### See Also:

- ["Application Synchronization"](#)
- ["Upgrading Applications in an Application Container"](#)

### 2.3.3.3.2 Applications at Different Versions

Different application PDBs might use different versions of the application.

For example, one application PDB might have version 1.0 of the `saas_sales_app`. In the same application container, another application PDB has version 2.0 of this application.

A use case is a SaaS application provided to different customers. If each customer has its own application PDB, then some customers might wait longer to upgrade the application. In this case, some application PDBs may use the latest version of the application, whereas other application PDBs use an older version.

**See Also:**

"[Upgrading Applications in an Application Container](#)" to learn more about applications at different versions

### 2.3.3.4 Application Patch

An **application patch** is a minor change to an application.

Typical examples of application patching include bug fixes and security patches. New functions and packages are permitted within a patch.

In general, destructive operations are not permitted. For example, a patch cannot include `DROP` statements, or `ALTER TABLE` statements that drop a column or change a data type.

Just as the Oracle Database patching process restricts the kinds of operations permitted in an Oracle Database patch, the application patching process restricts the operations permitted in an application patch. If a fix includes an operation that raises an "operation not supported in an application patch" error, then perform an [application upgrade](#) instead.

**Note:**

You cannot patch an application when another application patch or upgrade is in progress.

To patch the application, specify the application name and patch number in the `ALTER PLUGGABLE DATABASE APPLICATION` statement. Optionally, you can specify an application minimum version.

#### Example 2-13 Patching an Application Using the Automated Technique

In this example, `SYSTEM` logs in to the application root, and then patches the application `saas_sales_app` at version 1.0 or greater. Patch 101 logs in to the application container as `saas_sales_adm`, and then creates a metadata-linked PL/SQL function named `get_total_revenue`.

```
ALTER PLUGGABLE DATABASE APPLICATION saas_sales_app BEGIN PATCH 101
MINIMUM VERSION '1.0';
```

```
-- Connect to the saas_sales_ac container as saas_sales_adm, who owns the
application
CONNECT saas_sales_adm/*****@saas_sales_ac
```

```
-- Now install the get_total_revenue() function
CREATE FUNCTION get_total_revenue SHARING=METADATA (p_year IN NUMBER)
RETURN SYS_REFCURSOR
AS
c1_cursor SYS_REFCURSOR;
BEGIN
```

```
OPEN c1_cursor FOR
  SELECT a.year, sum(a.revenue)
  FROM containers(sales_data) a
  WHERE a.year = p_year
  GROUP BY a.year;
RETURN c1_cursor;
END;
/

-- End the patch
ALTER PLUGGABLE DATABASE APPLICATION saas_sales_app END PATCH 101;
```

**See Also:**

["Patching Applications in an Application Container"](#)

## 2.3.4 Migration of an Existing Application

You can migrate an application that is installed in a PDB to either an application root or to an application PDB.

Typical reasons for migrating a preexisting application include the following:

- Applications that use an installation program  
Some applications use an installation program rather than a script. In this case, you can run the installation program in a new application root, and then use the `DBMS_PDB_ALTER_SHARING` package to set the objects to the appropriate sharing mode: `METADATA`, `DATA`, or `EXTENDED DATA`. The root automatically propagates the changes to the application PDBs. Oracle Database creates a statement log of the installation, so PDBs with previous application versions can be plugged into the application root.
- Applications that are defined separately in each PDB  
Some applications are defined in each PDB, but no application container exists. In this case, you can update the installation script to set the appropriate sharing mode. You create an application root, and then create the master application definition in this root. You can adopt the existing PDBs as application PDBs by plugging them into the application root, and then running a SQL script to replace the full definitions with references to the common definitions.

For example, you can migrate an application installed in a PDB plugged into an Oracle Database 12c CDB to an application container in an Oracle Database 18c CDB.

 **See Also:**

- ["About Application Management"](#) to learn how to migrate an existing application
- *Oracle Database PL/SQL Packages and Types Reference* to learn more about the `DBMS_PDB_ALTER_SHARING` package

## 2.3.5 Implicitly Created Applications

In addition to user-created applications, application containers can also contain implicitly created applications.

An application is created implicitly in an application root when an application common user operation is issued with a `CONTAINER=ALL` clause without being preceded by an `ALTER PLUGGABLE DATABASE BEGIN` statement.

Application common user operations include operations such as creating a common user with a `CREATE USER` statement or altering a common user with an `ALTER USER` statement. The database automatically names an implicit application `APP$guid`, where *guid* is the global unique ID of the application root. An implicit application is created when the application root is opened for the first time.

 **See Also:**

["Synchronizing Applications in an Application PDB"](#) to learn more about implicitly created applications

## 2.3.6 Application Synchronization

Within an application PDB, synchronization is the user-initiated update of the application to the latest version and patch in the application root.

When you are connected to an application PDB, synchronize an application by issuing the `ALTER PLUGGABLE DATABASE APPLICATION` statement with the `SYNC` keyword. If you specify the application name before `SYNC`, then the database synchronizes only the specified application. If you do not specify the application name, or if you specify `ALL SYNC`, then the database synchronizes all applications, including implicitly created applications.

 **Note:**

When you are connected to the application root, the operations of installing, upgrading, and patching an application do not automatically propagate changes to the application PDBs.

**Example 2-14 Synchronizing a Specific Application in an Application PDB**

This following statement synchronizes an application named `saas_sales_app` with the latest application changes in the application root:

```
ALTER PLUGGABLE DATABASE APPLICATION saas_sales_app SYNC;
```

**Example 2-15 Synchronizing a Specific Application to a Patch in an Application PDB**

This following statement synchronizes an application named `saas_sales_app` with patch 100 in the application root:

```
ALTER PLUGGABLE DATABASE APPLICATION saas_sales_app SYNC TO PATCH 100;
```

**See Also:**

["Synchronizing Applications in an Application PDB"](#)

## 2.3.7 Container Maps

A **container map** enables a session connected to application root to issue SQL statements that are routed to the appropriate PDB, depending on the value of a predicate used in the SQL statement.

A map table specifies a column in a metadata-linked common table, and uses partitions to associate different application PDBs with different column values. In this way, container maps enable the partitioning of data at the PDB level when the data is not physically partitioned at the table level.

The key components for using container maps are:

- Metadata-linked table

This table is intended to be queried using the container map. For example, you might create a metadata-linked table named `countries_mlt` that stores different data in each application PDB. In `amer_pdb`, the `countries_mlt.cname` column stores North American country names; in `euro_pdb`, the `countries_mlt.cname` column stores European country names; and in `asia_pdb`, the `countries_mlt.cname` column stores Asian country names.

- Map table

In the application root, you create a single-column map table partitioned by list, hash, or range. The map table enables the metadata-linked table to be queried using the partitioning strategy that is enabled by the container map. The names of the partitions in the map object table must match the names of the application PDBs in the application container.

For example, the map table named `pdb_map_tbl` may partition by list on the `cname` column. The partitions named `amer_pdb`, `euro_pdb`, and `asia_pdb` correspond to the names of the application PDBs. The values in each partition are the names of

the countries, for example, `PARTITION amer_pdb VALUES ('US', 'MEXICO', 'CANADA')`.

Starting in Oracle Database 18c, for a `CONTAINERS()` query to use a map, the partitioning column in the map table does not need to match a column in the metadata-linked table. Assume that the table `sh.sales` is enabled for the container `map_pdb_map_tbl`, and `cname` is the partitioning column for the map table. Even though `sh.sales` does *not* include a `cname` column, the map table routes the following query to the appropriate PDB: `SELECT * FROM CONTAINERS(sh.sales) WHERE cname = 'US' ORDER BY time_id`.

- Container map

A container map is a database property that specifies a map table. To set the property, you connect to the application root and execute the `ALTER PLUGGABLE DATABASE SET CONTAINER_MAP=map_table` statement, where `map_table` is the name of the map table.

### Example 2-16 Creating a Metadata-Linked Table, Map Table, and Container Map: Part 1

In this example, you log in as an application administrator to the application root. Assume that an application container has three application PDBs: `amer_pdb`, `euro_pdb`, and `asia_pdb`. Each application PDB stores country names for a different region. A metadata-linked table named `oe.countries_mlt` has a `cname` column that stores the country name. For this partitioning strategy, you use partition by list to create a map object named `salesadm.pdb_map_tbl` that creates a partition for each region. The country name determines the region.

```
ALTER PLUGGABLE DATABASE APPLICATION saas_sales_app BEGIN INSTALL '1.0';

-- Create the metadata-linked table.
CREATE TABLE oe.countries_mlt SHARING=METADATA (
  region  VARCHAR2(30),
  cname   VARCHAR2(30));

-- Create the partitioned map table, which is list partitioned on the
-- cname column.
-- The names of the partitions are the names of the application PDBs.
CREATE TABLE salesadm.pdb_map_tbl (cname VARCHAR2(30) NOT NULL)
  PARTITION BY LIST (cname) (
    PARTITION amer_pdb VALUES ('US','MEXICO','CANADA'),
    PARTITION euro_pdb VALUES ('UK','FRANCE','GERMANY'),
    PARTITION asia_pdb VALUES ('INDIA','CHINA','JAPAN'));

-- Set the CONTAINER_MAP database property to the map object.
ALTER PLUGGABLE DATABASE SET CONTAINER_MAP='salesadm.pdb_map_tbl';

-- Enable the container map for the metadata-linked table to be queried.
ALTER TABLE oe.countries_mlt ENABLE CONTAINER_MAP;

-- Ensure that the table to be queried is enabled for the CONTAINERS
-- clause.
ALTER TABLE oe.countries_mlt ENABLE CONTAINERS_DEFAULT;
```

```
-- End the application installation.  
ALTER PLUGGABLE DATABASE APPLICATION saas_sales_app END INSTALL '1.0';
```

 **Note:**

Although you create container maps using partitioning syntax, the database does not use partitioning functionality. Defining a container map does not require Oracle Partitioning.

In the preceding script, the `ALTER TABLE oe.countries_mlt ENABLE CONTAINERS_DEFAULT` statement specifies that queries and DML statements issued in the application root must use the `CONTAINERS()` clause by default for the database object.

### Example 2-17 Synchronizing the Application, and Adding Data: Part 2

This example continues from the previous example. While connected to the application root, you switch the current container to each PDB in turn, synchronize the `saas_sales_app` application, and then add PDB-specific data to the `oe.countries_mlt` table.

```
ALTER SESSION SET CONTAINER=amer_pdb;  
ALTER PLUGGABLE DATABASE APPLICATION saas_sales_app SYNC;  
INSERT INTO oe.countries_mlt VALUES ('AMER','US');  
INSERT INTO oe.countries_mlt VALUES ('AMER','MEXICO');  
INSERT INTO oe.countries_mlt VALUES ('AMER','CANADA');  
COMMIT;
```

```
ALTER SESSION SET CONTAINER=euro_pdb;  
ALTER PLUGGABLE DATABASE APPLICATION saas_sales_app SYNC;  
INSERT INTO oe.countries_mlt VALUES ('EURO','UK');  
INSERT INTO oe.countries_mlt VALUES ('EURO','FRANCE');  
INSERT INTO oe.countries_mlt VALUES ('EURO','GERMANY');  
COMMIT;
```

```
ALTER SESSION SET CONTAINER=asia_pdb;  
ALTER PLUGGABLE DATABASE APPLICATION saas_sales_app SYNC;  
INSERT INTO oe.countries_mlt VALUES ('ASIA','INDIA');  
INSERT INTO oe.countries_mlt VALUES ('ASIA','CHINA');  
INSERT INTO oe.countries_mlt VALUES ('ASIA','JAPAN');  
COMMIT;
```

### Example 2-18 Querying the Metadata-Linked Table: Part 3

This example continues from the previous example. You connect to the application root, and then query `oe.countries_mlt` multiple times, specifying different countries in the `WHERE` clause. The query returns the correct value from the `oe.countries_mlt.region` column.

```
ALTER SESSION SET CONTAINER=saas_sales_ac;  
  
SELECT region FROM oe.countries_mlt WHERE cname='MEXICO';
```

```
REGION
-----
AMER

SELECT region FROM oe.countries_mlt WHERE cname='GERMANY';

REGION
-----
EURO

SELECT region FROM oe.countries_mlt WHERE cname='JAPAN';

REGION
-----
ASIA
```



**See Also:**

["Partitioning by PDB with Container Maps"](#)

## 2.4 Overview of Services in a CDB

Clients must connect to PDBs or application roots using services.

A connection using a service name starts a new session in a PDB or application root. A foreground process, and therefore a session, at every moment of its lifetime, has a uniquely defined current container.

The following graphic shows two clients connecting to PDBs using two different listeners.



Figure 2-10 Services in a CDB

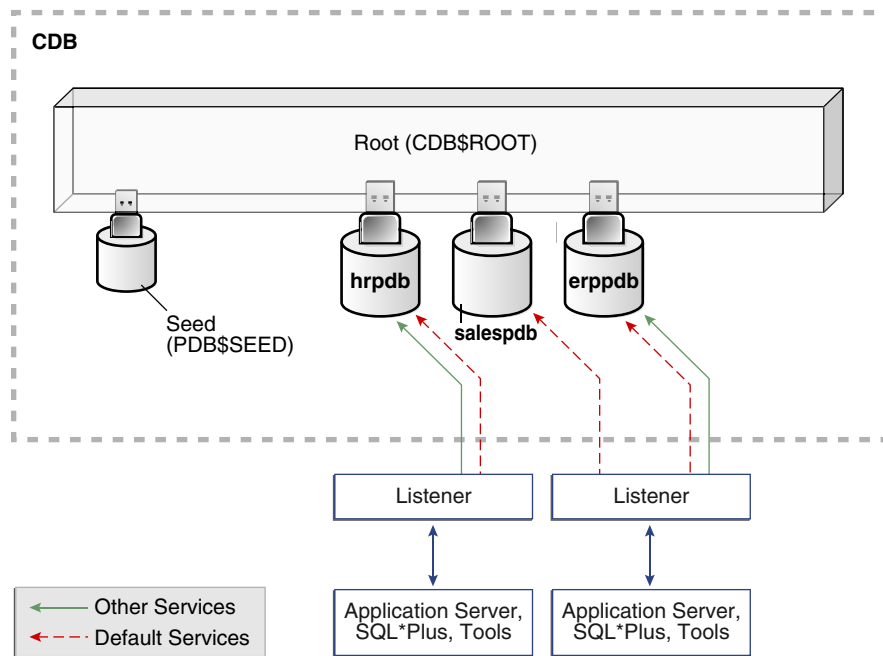

This section contains the following topics:

- [Service Creation in a CDB](#)  
When you execute the `CREATE PLUGGABLE DATABASE` statement to create a PDB, the database automatically creates and starts a service inside the CDB.
- [Connections to Containers in a CDB](#)  
Typically, a CDB administrator must have appropriate privileges to provision PDBs and connect to various containers. CDB administrators are common users.



**See Also:**

["Managing Services for PDBs"](#)

## 2.4.1 Service Creation in a CDB

When you execute the `CREATE PLUGGABLE DATABASE` statement to create a PDB, the database automatically creates and starts a service inside the CDB.

The default service has a property that identifies the PDB as the initial current container for the service. The property is shown in the `DBA_SERVICES.PDB` column.

This section contains the following topics:

- [Default Services in a CDB](#)  
The default service has the same name as the PDB. The PDB name must be a valid service name, which must be unique within the CDB.

- [Nondefault Services in a CDB](#)  
You can create additional services for each PDB, up to a per-CDB maximum of 10,000. Each additional service denotes its PDB as the initial current container.

**See Also:**

["Managing Services for PDBs"](#)

### 2.4.1.1 Default Services in a CDB

The default service has the same name as the PDB. The PDB name must be a valid service name, which must be unique within the CDB.

When you create an application container, which requires specifying the `AS APPLICATION CONTAINER` clause, Oracle Database automatically creates a new default service for the application root. The service has the same name as the application container. Oracle Net Services must be configured properly for clients to access this service. Similarly, every application PDB has its own default service name, and an application seed PDB has its own default service name.

#### Example 2-19 Switching to a PDB Using a Default Service

This example switches to the PDB names `salespdb` using the default service, which has the same name as the PDB:

```
ALTER SESSION SET CONTAINER = salespdb;
```

**See Also:**

- *Oracle Database Concepts* for information about service names
- ["Managing Services for PDBs"](#)

### 2.4.1.2 Nondefault Services in a CDB

You can create additional services for each PDB, up to a per-CDB maximum of 10,000. Each additional service denotes its PDB as the initial current container.

In [Figure 2-10](#), nondefault services exist for `erppdb` and `hrpdb`. Create, maintain, and drop additional services using the same techniques that you use in a non-CDB.

For example, in [Figure 2-10](#) the PDB named `hrpdb` has a default service named `hrpdb`. The default service cannot be dropped.

When you switch to a container using `ALTER SESSION SET CONTAINER`, the session uses the default service for the container. Optionally, you can use a different service for the container by specifying `SERVICE = service_name`, where `service_name` is the name of the service. You might want to use a particular service so that the session can

take advantage of its service attributes and features, such as service metrics, load balancing, Resource Manager settings, and so on.

**Example 2-20 Switching to a PDB Using a Nondefault Service**

In this example, the default service for `hrpdb` does not support all the service attributes and features such as service metrics, FAN, load balancing, Oracle Database Resource Manager, Transaction Guard, Application Continuity, and so on. You switch to a nondefault service as follows:

```
ALTER SESSION SET CONTAINER = hrpdb SERVICE = hrpdb_full;
```

## 2.4.2 Connections to Containers in a CDB

Typically, a CDB administrator must have appropriate privileges to provision PDBs and connect to various containers. CDB administrators are common users.

The CDB administrator can use either of the following techniques:

- Connect directly to a PDB or application root.  
The user requires the `CREATE SESSION` privilege in the container.
- Use the `ALTER SESSION SET CONTAINER` statement, which is useful for both connection pooling and advanced CDB administration, to switch between containers. The syntax is `ALTER SESSION SET CONTAINER = container_name [SERVICE = service_name]`.

For example, a CDB administrator can connect to the root in one session, and then in the same session switch to a PDB. In this case, the user requires the `SET CONTAINER` system privilege in the container.

The following table describes a scenario involving the CDB in [Figure 2-10](#). Each row describes an action that occurs after the action in the preceding row. Common user `SYSTEM` queries the name of the current container and the names of PDBs in the CDB.

**Table 2-8 Services in a CDB**

Operation	Description
<pre>SQL&gt; CONNECT SYSTEM@prod Enter password: ***** Connected.</pre>	<p>The <code>SYSTEM</code> user, which is common to all containers in the CDB, connects to the root using service named <code>prod</code>.</p>
<pre>SQL&gt; SHOW CON_NAME  CON_NAME ----- CDB\$ROOT</pre>	<p><code>SYSTEM</code> uses the <code>SQL*Plus</code> command <code>SHOW CON_NAME</code> to list the name of the container to which the user is currently connected. <code>CDB\$ROOT</code> is the name of the root container.</p>

Table 2-8 (Cont.) Services in a CDB

Operation	Description
<pre>SQL&gt; SELECT NAME, PDB FROM V\$SERVICES 2  ORDER BY PDB, NAME;</pre> <pre>NAME                                PDB -----                                -</pre> <pre>SYS\$BACKGROUND                      CDB\$ROOT SYS\$USERS                             CDB\$ROOT prod.example.com                     CDB\$ROOT erppdb.example.com                   ERPPDB erp.example.com                      ERPPDB hr.example.com                       HRPDB hrpdb.example.com                   HRPDB salespdb.example.com                 SALESPDB</pre> <p>8 rows selected.</p>	<p>A query of V\$SERVICES shows that three PDBs exist with service names that match the PDB name. Both hrpdb and erppdb have an additional service.</p>
<pre>SQL&gt; ALTER SESSION SET CONTAINER = hrpdb;</pre> <p>Session altered.</p>	<p>SYSTEM uses ALTER SESSION to connect to hrpdb.</p>
<pre>SQL&gt; SELECT SYS_CONTEXT 2  ('USERENV', 'CON_NAME') 3  AS CUR_CONTAINER FROM DUAL;</pre> <pre>CUR_CONTAINER ----- HRPDB</pre>	<p>A query confirms that the current container is now hrpdb.</p>



#### See Also:

- ["Connecting to a PDB"](#)
- *Oracle Database SQL Language Reference* for the syntax and semantics of ALTER SESSION SET CONTAINER

## 2.5 Overview of Tablespaces and Database Files in a CDB

A CDB has the same structure as a non-CDB, except that each PDB and application root has its own set of tablespaces, including its own SYSTEM, SYSAUX, and undo tablespaces.

A CDB contains the following files:

- One control file
- One online redo log
- One or more undo tablespaces

Only a common user who has the appropriate privileges and whose current container is the root can create an undo tablespace. At any given time, a CDB is either in either of the following undo modes:

– Local undo mode

In this case, each PDB has its own undo tablespace. If a CDB is using local undo mode, then the database automatically creates an undo tablespace in every PDB. Local undo provides advantages such as the ability to perform a hot clone of a PDB, and speed the relocation of a PDB. Also, local undo provides level of isolation and enables faster unplug and point-in-time recovery operations.

A local undo tablespace is required for each node in an Oracle Real Application Clusters (RAC) cluster in which the PDB is open. For example, if you move a PDB from a two-node cluster to a four-node cluster, and if the PDB is open in all nodes, then the database automatically creates the additional required undo tablespaces. If you move the PDB back again, then you can drop the redundant undo tablespaces.

 **Note:**

By default, Database Configuration Assistant (DBCA) creates new CDBs with local undo enabled.

– Shared undo mode

In a single-instance CDB, only one active undo tablespace exists. For an Oracle RAC CDB, one active undo tablespace exists for every instance. All undo tablespaces are visible in the data dictionaries and related views of all containers.

The undo mode applies to the entire CDB, which means that every container uses shared undo, or every container uses local undo. You can switch between undo modes in a CDB, which necessitates re-starting the database.

- `SYSTEM` and `SYSAUX` tablespaces for every container

The primary physical difference between CDBs and non-CDBs is the data files in `SYSTEM` and `SYSAUX`. A non-CDB has only one `SYSTEM` tablespace and one `SYSAUX` tablespace. In contrast, the CDB root, each [application root](#), and each PDB in a CDB has its own `SYSTEM` and `SYSAUX` tablespaces. Each container also has its own set of dictionary tables describing the objects that reside in the container.

- Zero or more user-created tablespaces

In a typical use case, each PDB has its own set of non-system tablespaces. These tablespaces contain the data for user-defined schemas and objects in the PDB.

Within a PDB, you manage permanent and temporary tablespaces in the same way that you manage them in a non-CDB. You can also limit the amount of

storage used by the data files for a PDB by using the `STORAGE` clause in a `CREATE PLUGGABLE DATABASE` or `ALTER PLUGGABLE DATABASE` statement.

The storage of the data dictionary within the PDB enables it to be portable. You can unplug a PDB from a CDB, and plug it in to a different CDB.

- A set of temp files for every container

One default temporary tablespace exists for the CDB root, and one for each [application root](#), [application PDB](#), and PDB.

### Example 2-21 CDB in Local Undo Mode

This example shows aspects of the physical storage architecture of a CDB with two PDBs: `hrpdb` and `salespdb`. In this example, the database uses local undo mode, and so has undo data files in the CDB root, `hrpdb`, and `salespdb`.

Figure 2-11 Physical Architecture of a CDB in Local Undo Mode

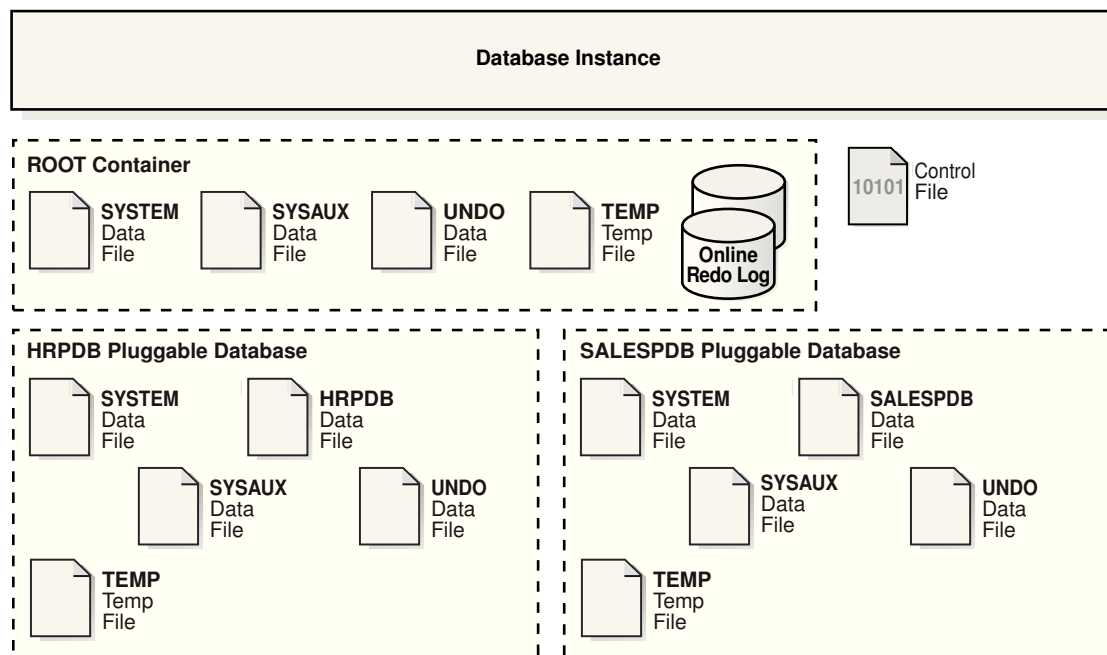

#### See Also:

- ["Data Dictionary Architecture in a CDB"](#)
- ["After Creating a CDB"](#) to learn about the state of a CDB after creation

## 2.6 Overview of Availability in a CDB

Many availability features that exist for a non-CDB also exist for individual PDBs within a CDB.

This section contains the following topics:

- [Overview of Backup and Recovery in a CDB](#)  
RMAN and Oracle Enterprise Manager Cloud Control provide full support for backup and recovery in a multitenant environment.
- [Overview of Flashback PDB in a CDB](#)  
You can rewind a PDB using the `FLASHBACK PLUGGABLE DATABASE` command in SQL or Recovery Manager. This command is analogous to `FLASHBACK DATABASE` in a non-CDB.

## 2.6.1 Overview of Backup and Recovery in a CDB

RMAN and Oracle Enterprise Manager Cloud Control provide full support for backup and recovery in a multitenant environment.

You can back up and recover a whole CDB, the root only, or one or more PDBs. You can also back up and recover individual tablespaces and data files within a PDB.

From the perspective of recovery, separately backing up the root and all PDBs is equivalent to backing up the whole CDB. The main difference is in the number of RMAN commands that you must enter and the time to recover. Recovering a whole CDB requires less time than recovering the CDB root plus all PDBs.

You can perform complete recovery of one or more PDBs without affecting operations of other open PDBs. RMAN also provides support for point-in-time recovery at the PDB level. The procedure is similar to the procedure for point-in-time recovery of a non-CDB.

### See Also:

*Oracle Database Backup and Recovery User's Guide* to learn about the state of a CDB after creation

## 2.6.2 Overview of Flashback PDB in a CDB

You can rewind a PDB using the `FLASHBACK PLUGGABLE DATABASE` command in SQL or Recovery Manager. This command is analogous to `FLASHBACK DATABASE` in a non-CDB.

Flashback PDB protects an individual PDB against data corruption, widespread user errors, and redo corruption. The operation does not rewind data in other PDBs in the CDB.

In releases prior to Oracle Database 12c Release 2 (12.2), you could create a restore point—an alias for an SCN—only when connected to the root. Now you can use `CREATE RESTORE POINT ... FOR PLUGGABLE DATABASE` to create a [PDB restore point](#), which is only usable within a specified PDB. As with CDB restore points, PDB restore points can be normal or guaranteed. A guaranteed restore point never ages out of the control file and must be explicitly dropped. If you connect to the root, and if you do not specify the `FOR PLUGGABLE DATABASE` clause, then you create a [CDB restore point](#), which is usable by all PDBs.

A special type of PDB restore point is a [clean restore point](#), which you can only create when a PDB is closed. For PDBs with shared undo, rewinding the PDB to a clean restore point preserves database consistency and improves performance. The database avoids using the automatic infrastructure, which can reduce performance.

 **See Also:**

*Oracle Database Backup and Recovery User's Guide* to learn about using  
FLASHBACK PLUGGABLE DATABASE

## 2.7 Overview of Oracle Resource Manager in a CDB

Using Oracle Resource Manager (Resource Manager), you can create CDB resource plans and set initialization parameters to allocate resources to PDBs.

In a non-CDB, you can use Resource Manager to manage multiple workloads that are contending for system and database resources. Therefore, in a CDB, multiple workloads within multiple PDBs can also compete for system and CDB resources.

In a CDB, Resource Manager can manage resources on two levels: CDB and PDB.

### CDB Resource Plans

A CDB resource plan allocates resources to its PDBs according to its set of resource plan directives (directives). A parent-child relationship exists between a CDB resource plan and its directives. Each resource plan directive references either a set of PDBs or an individual PDB.

A performance profile specifies shares of system resources for a set of PDBs. PDB performance profiles enable you to manage resources for large numbers of PDBs by specifying Resource Manager directives for profiles instead of individual PDBs.

The directives control allocation of CPU and parallel execution servers. A directive can control the allocation of resources to PDBs based on the share value that you specify for each PDB or PDB performance profile. A higher share value results in more guaranteed resources. For PDBs and PDB performance profiles, you can also set utilization limits for CPU and parallel servers.

You can create a CDB resource plan by using the `CREATE_CDB_PLAN` procedure in the `DBMS_RESOURCE_MANAGER` PL/SQL package, and set a CDB resource plan using the `RESOURCE_MANAGER_PLAN` parameter. You create directives for a CDB resource plan by using the `CREATE_CDB_PLAN_DIRECTIVE` procedure.

### PDB Resource Plans

A CDB resource plan allocates a portion of the system resources to a PDB. A PDB resource plan determines how this portion is allocated within the PDB.

Create a PDB resource plan in the same way that you create a resource plan for a non-CDB: by using procedures in the `DBMS_RESOURCE_MANAGER` package to create the plan.

You can create a PDB resource plan by using the `CREATE_PLAN` procedure in the `DBMS_RESOURCE_MANAGER` PL/SQL package, and set a PDB resource plan using the



`RESOURCE_MANAGER_PLAN` parameter. You create directives for a PDB resource plan by using the `CREATE_PLAN_DIRECTIVE` procedure.

### PDB-Level Memory Controls

In a CDB, PDBs may contend for SGA or PGA memory. Several initialization parameters can control the memory usage of a PDB, either guaranteeing memory or limiting memory. When you set the following initialization parameters with the PDB as the current container, the parameters control the memory usage of the current PDB.

Examples of important parameters include:

- `SGA_MIN_SIZE` sets the minimum guaranteed SGA size of the PDB.
- `SGA_TARGET` specifies the maximum SGA that the PDB can use at any time.
- `PGA_AGGREGATE_LIMIT` sets the maximum PGA that the PDB can use at any time.

### PDB-Level I/O Controls

Intensive disk I/O can cause poor performance. Several factors can result in excess disk I/O, such as poorly designed SQL or index and table scans in high-volume transactions. If one PDB generates excessive disk I/O, then it can degrade the performance of other PDBs in the same CDB.

On non-Engineered Systems, use one or both of the following initialization parameters to limit the I/O generated by a particular PDB:

- `MAX_IOPS` limits the number of I/O operations for each second.
- `MAX_MBPS` limits the MB/s for I/O operations.

For Engineered Systems, manage PDB I/Os with I/O Resource Management.

#### See Also:

- *Oracle Database Concepts* for information about Database Resource Manager
- ["Using Oracle Resource Manager for PDBs"](#)
- *Oracle Database Reference* to learn more about `DB_CACHE_SIZE` and other initialization parameters
- *Oracle Database PL/SQL Packages and Types Reference* to learn more about the `DBMS_RESOURCE_MANAGER` package
- *Oracle Exadata Storage Server Software User's Guide* to learn more about I/O Resource Management

# Part II

## Creating and Configuring a Multitenant Environment

You can create and configure a multitenant environment.

This part contains the following chapters:

- [Overview of Configuring and Managing a Multitenant Environment](#)  
Become familiar with basic concepts related to configuring and managing a multitenant environment.
- [Creating and Configuring a CDB](#)  
Creating and configuring a multitenant container database (CDB) includes tasks such as planning, creating the CDB, and optionally configuring EM Express.

# 3

## Overview of Configuring and Managing a Multitenant Environment

Become familiar with basic concepts related to configuring and managing a multitenant environment.

This chapter contains the following topics:

- [About Configuring and Managing a Multitenant Environment](#)  
You can use the Oracle Multitenant option to configure and manage a multitenant environment.
- [Prerequisites for a Multitenant Environment](#)  
Prerequisites must be met for a multitenant environment.
- [Tasks and Tools for a Multitenant Environment](#)  
There are common tasks you perform for a multitenant environment, and you use tools to complete the tasks.

### 3.1 About Configuring and Managing a Multitenant Environment

You can use the Oracle Multitenant option to configure and manage a multitenant environment.

You must meet certain prerequisites before configuring and managing a multitenant environment. To do so, you complete some common tasks and use a set of tools to complete those tasks.

The multitenant architecture enables an Oracle database to function as a multitenant container database (CDB) that includes zero, one, or many customer-created pluggable databases (PDBs). A PDB is a portable collection of schemas, schema objects, and nonschema objects that appears to an Oracle Net client as a non-CDB. All Oracle databases before Oracle Database 12c were non-CDBs.

This section contains the following topics:

- [Common Users and Local Users](#)  
A common user is a user that has the same identity in the root and in every existing and future PDB.
- [Separation of Duties in CDB and PDB Administration](#)  
Some database administrators manage an entire CDB, while others manage individual PDBs.

 **See Also:**

- ["Introduction to the Multitenant Architecture "](#)
- ["Overview of the Multitenant Architecture "](#)

### 3.1.1 Common Users and Local Users

A common user is a user that has the same identity in the root and in every existing and future PDB.

A common user can log in to the root and any container in which it has been granted `CREATE SESSION` privilege. The operations that a common user can perform depend on the privileges granted to the common user. Some administrative tasks, such as creating a PDB or unplugging a PDB, must be performed by a common user.

A CDB also supports local users. A local user is a user that exists in exactly one PDB.

 **See Also:**

- ["Overview of Commonality in the CDB"](#)
- *Oracle Database Security Guide* for more information about common users and local users

### 3.1.2 Separation of Duties in CDB and PDB Administration

Some database administrators manage an entire CDB, while others manage individual PDBs.

DBAs who manage an entire CDB connect to the CDB as common users, and manage attributes of the entire CDB and the root, as well as some attributes of PDBs. For example, these DBAs can create, unplug, plug in, and drop PDBs. They can also specify the temporary tablespace and the default tablespace for the root, and they can change the open mode of PDBs.

DBAs can also connect to a specific PDB as a local PDB administrator and then perform a subset of management tasks on the PDB that a DBA performs on a non-CDB. The subset includes tasks required for the PDB to support an [application](#). For example, tasks can include management of tablespaces and schemas in a PDB, specification of storage parameters for that PDB, changing the open mode of the current PDB, and setting PDB-level initialization parameters.

## 3.2 Prerequisites for a Multitenant Environment

Prerequisites must be met for a multitenant environment.

The following prerequisites must be met before you can create and use a multitenant environment:

- Install Oracle Database 12c.  
The installation includes setting various environment variables unique to your operating system and establishing the directory structure for software and database files.
- Set the database compatibility level to at least 12.0.0.

 **See Also:**

- *Oracle Database Installation Guide* specific to your operating system
- *Oracle Database Upgrade Guide* for information about the database compatibility level

## 3.3 Tasks and Tools for a Multitenant Environment

There are common tasks you perform for a multitenant environment, and you use tools to complete the tasks.

This section contains the following topics:

- [Tasks for a Multitenant Environment](#)  
A multitenant environment enables you to achieve several goals. You can complete general tasks to configure and use a multitenant environment.
- [Tools for a Multitenant Environment](#)  
You can use various tools to configure and administer a multitenant environment.

### 3.3.1 Tasks for a Multitenant Environment

A multitenant environment enables you to achieve several goals. You can complete general tasks to configure and use a multitenant environment.

These goals are described in "[Benefits of the Multitenant Architecture](#)". To do so, you must complete the following general tasks:

#### **Task 1 Plan for the Multitenant Environment**

Creating and configuring any database requires careful planning. A CDB requires special considerations. For example, consider the following factors when you plan for a CDB:

- The number of PDBs that will be plugged into each CDB
- The resources required to support the planned CDB
- Container management policies executed as an aggregate on the entire CDB or executed locally on individual PDBs
- Container database topology, which could consist of application containers with application PDBs or a CDB with PDBs, or a combination of both

See "[Planning for CDB Creation](#)" for detailed information about planning for a CDB.

### Task 2 Create One or More CDBs

When you have completed the necessary planning, you can create one or more CDBs using either the Database Configuration Assistant (DBCA) or the `CREATE DATABASE` statement. In either case, you must specify the configuration details for each CDB. See "[About CDB Creation with DBCA](#)" and "[Creating a CDB](#)" for detailed information about creating a CDB.

After a CDB is created, it consists of the root and `PDB$SEED`, as shown in [Figure 3-1](#). The CDB root contains only Oracle maintained objects and data structures, and `PDB$SEED` is a generic seed database for cloning purposes.

Figure 3-1 A Newly Created CDB

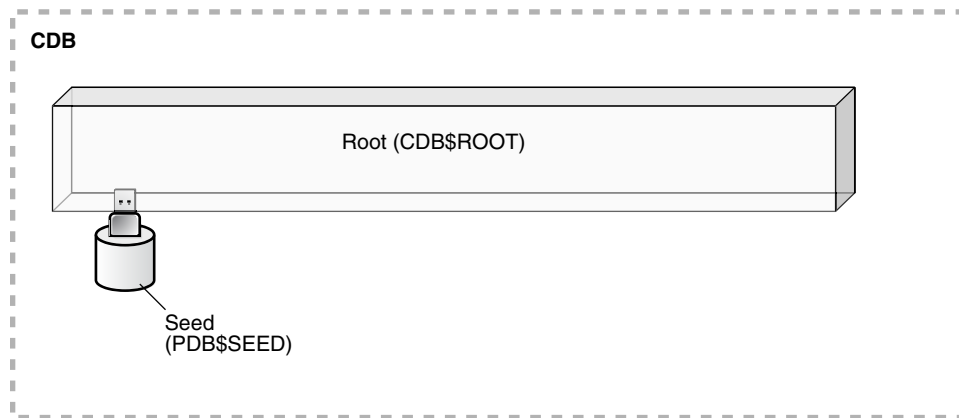

### Task 3 Optionally, Create Application Containers

An application container is an optional component of a CDB that consists of an application root and the application PDBs associated with it. An application container stores data for one or more applications.

The following graphic shows a CDB with one empty application container.

Figure 3-2 An Application Container

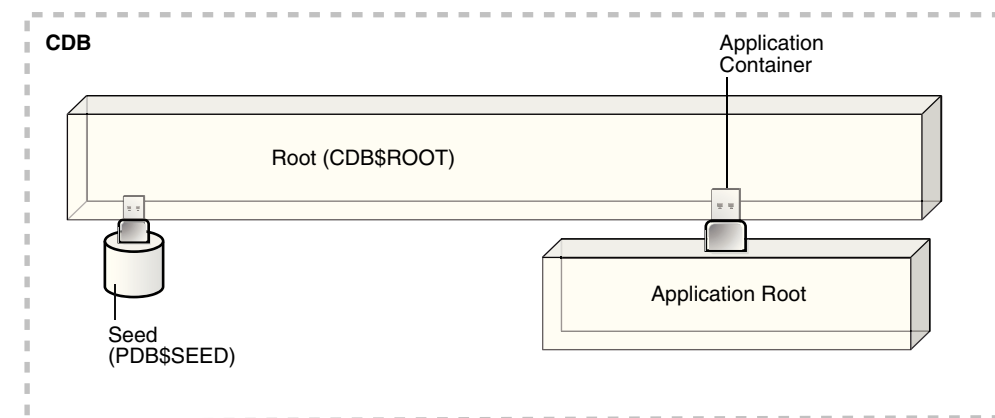

See "[Overview of Applications in an Application Container](#)".

#### Task 4 Create, Plug In, and Unplug PDBs

PDBs contain user data. After creating a CDB, you can create PDBs, plug unplugged PDBs into it, and unplug PDBs from it whenever necessary. You can unplug a PDB from a CDB and plug this PDB into a different CDB. You might move a PDB from one CDB to another if, for example, you want to move the workload for the PDB from one server to another.

See "[Creating and Removing PDBs and Application Containers](#)" and "[Creating and Removing PDBs with Cloud Control](#)" for information about creating PDBs, plugging in PDBs, and unplugging PDBs.

[Figure 3-3](#) shows a CDB with several PDBs.

**Figure 3-3 A CDB with PDBs**

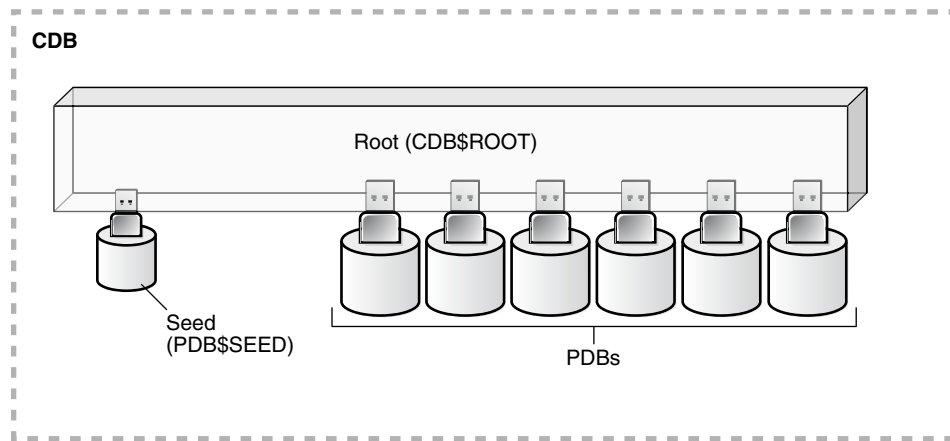

[Figure 3-4](#) shows a CDB with PDBs, application containers, and application PDBs.

Figure 3-4 A CDB with PDBs, Application Containers, and Application PDBs

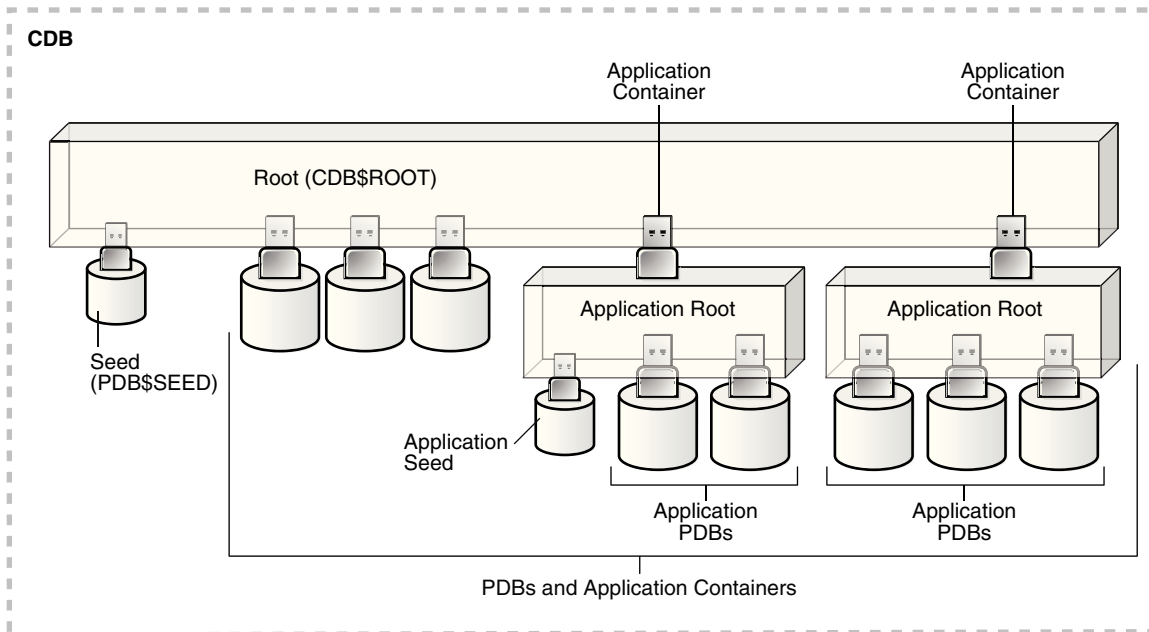

#### Task 5 Administer and Monitor the CDB and Application Containers

Administering and monitoring a CDB involves managing the entire CDB, the root, and some attributes of PDBs. Some management tasks are the same for CDBs and non-CDBs, and some are different.

Administering and monitoring an application container is similar to administering and monitoring a CDB, but your actions only affect the application root and the application PDBs that are part of the application container.

See "[After Creating a CDB](#)" for descriptions of tasks that are similar and tasks that are different. Also, see "[Administering a CDB](#)", "[Administering CDBs and PDBs with Cloud Control](#)", and "[Monitoring CDBs and PDBs](#)".

You can use Oracle Resource Manager to allocate and manage resources among PDBs hosted in a CDB, and you can use it to allocate and manage resource use among user processes within a PDB. See "[Using Oracle Resource Manager for PDBs](#)".

You can also use Oracle Scheduler to schedule jobs in a CDB and in individual PDBs. See "[Using Oracle Scheduler with a CDB](#)".

#### Task 6 Administer and Monitor PDBs and Application PDBs

Administering and monitoring a PDB or an application PDB is similar to administering and monitoring a non-CDB, but there are some differences. See "[Administering CDBs and PDBs with Cloud Control](#)", "[Administering PDBs](#)", and "[Monitoring CDBs and PDBs](#)".

### 3.3.2 Tools for a Multitenant Environment

You can use various tools to configure and administer a multitenant environment.



**Table 3-1 Tools for a Multitenant Environment**

Tool	Description	See Also
SQL*Plus	SQL*Plus is a command-line tool that enables you to create, manage, and monitor CDBs and PDBs. You use SQL statements and Oracle-supplied PL/SQL packages to complete these tasks in SQL*Plus.	<i>SQL*Plus User's Guide and Reference</i>
DBCA	Oracle Database Configuration Assistant (DBCA) is a utility with a graphical user interface that enables you to configure a CDB, duplicate a CDB, create and clone PDBs, plug in PDBs, and unplug PDBs.	<i>Oracle Database 2 Day DBA</i> , <i>Oracle Database Installation Guide</i> , and the DBCA online help
Oracle Enterprise Manager Cloud Control	Cloud Control is a system management tool with a graphical user interface that enables you to manage and monitor a CDB and its PDBs.	Cloud Control online help
Oracle SQL Developer	Oracle SQL Developer is a client application with a graphical user interface that enables you to configure a CDB, create PDBs, plug and unplug PDBs, modify the state of a PDB, clone a PDB to the Oracle Cloud, hot clone/refresh a PDB, relocate a PDB between application roots, and more. Additionally, Oracle SQL Developer has graphical interfaces for resource management, storage, security, configuration, and reporting of performance metrics on containers and pluggable databases in a CDB.	<a href="https://www.oracle.com/database/technologies/appdev/sql-developer.html">https://www.oracle.com/database/technologies/appdev/sql-developer.html</a> for downloads and documentation
The Server Control (SRVCTL) utility	The SRVCTL utility can create and manage services for PDBs.	" <a href="#">Managing Services for PDBs</a> "
EM Express	EM Express is a management and monitoring tool with a graphical user interface which ships with Oracle Database. It can be configured for the CDB, individual hosted PDBs, or both. This tool is intended for PDB administrative use, in the context of the PDB, to manage and monitor application development as an application DBA.	<i>Oracle Database 2 Day DBA</i>
Oracle Multitenant Self-Service Provisioning application	This application enables the self-service provisioning of PDBs. CDB administrators control access to this self-service application and manage quotas on PDBs.	<a href="http://www.oracle.com/goto/multitenant">http://www.oracle.com/goto/multitenant</a> To access the application, click the <b>Downloads</b> tab, and select <b>Oracle Pluggable Database Self-Service Provisioning application</b> in the Downloads for Oracle Multitenant section.

# 4

## Creating and Configuring a CDB

Creating and configuring a multitenant container database (CDB) includes tasks such as planning, creating the CDB, and optionally configuring EM Express.

This section contains the following topics:

- [About Creating a CDB](#)  
The procedure for creating a multitenant container database (CDB) is similar to the procedure for creating a non-CDB.
- [Planning for CDB Creation](#)  
CDB creation prepares several operating system files to work together as a CDB.
- [Creating a CDB](#)  
You can create a CDB using DBCA or by manually issuing the `CREATE DATABASE` SQL statement.
- [Configuring EM Express for a CDB](#)  
For a CDB, you can configure Oracle Enterprise Manager Database Express (EM Express) for the root and for each PDB by setting a global HTTPS port, or you can set a different port for every container in the CDB.
- [After Creating a CDB](#)  
After creation, a CDB consists of the root and the PDB seed.

### 4.1 About Creating a CDB

The procedure for creating a multitenant container database (CDB) is similar to the procedure for creating a non-CDB.

The procedure for creating a non-CDB is described in *Oracle Database Administrator's Guide*. Before creating a CDB, you must understand the concepts and tasks described in this documentation.

This chapter describes special considerations for creating a CDB. This chapter also describes differences between the procedure for creating a non-CDB in *Oracle Database Administrator's Guide* and the procedure for creating a CDB.

After you plan your CDB using some of the guidelines presented in "[Planning for CDB Creation](#)", you can create the CDB either during or after Oracle Database software installation. The following are typical reasons to create a CDB after installation:

- You used Oracle Universal Installer (OUI) to install software only, and did not create a CDB.
- You want to create another CDB on the same host as an existing CDB or an existing non-CDB. In this case, this chapter assumes that the new CDB uses the same Oracle home as the existing database. You can also create the CDB in a new Oracle home by running OUI again.

The specific methods for creating a CDB are:

- With the Database Configuration Assistant (DBCA), a graphical tool.

See "[About CDB Creation with DBCA](#)".

- With the `CREATE DATABASE SQL` statement.  
See "[Creating a CDB](#)".

## 4.2 Planning for CDB Creation

CDB creation prepares several operating system files to work together as a CDB.



### Note:

Before planning for CDBs, review the conceptual information about CDBs and PDBs in "[Introduction to the Multitenant Architecture](#)".

This section contains the following topics:

- [Decide How to Configure the CDB](#)  
Prepare to create the CDB by research and careful planning.
- [Prerequisites for CDB Creation](#)  
You must complete prerequisites before creating a new CDB.

### 4.2.1 Decide How to Configure the CDB

Prepare to create the CDB by research and careful planning.

As a first step, consult the *Oracle Database Release Notes*, which includes a list of Oracle Database features that are currently not supported in a CDB. If you must use one or more of these features, then create a non-CDB.

The following sections describe recommended actions and considerations that apply to CDBs:

- [Plan the PDBs](#)  
Plan the tables and indexes for the pluggable databases (PDBs) and estimate the amount of space they require.
- [Plan the Physical Layout](#)  
Plan the layout of the underlying operating system files your CDB will comprise.
- [Learn How to Manage Initialization Parameters](#)  
Familiarize yourself with the initialization parameters that can be included in an initialization parameter file.
- [Select the Character Set](#)  
You must choose a character set for the CDB.
- [Decide Which Time Zones to Support](#)  
Consider which time zones your CDB must support.
- [Select the Database and Redo Log Block Sizes](#)  
Select the standard database block size for the CDB.
- [Plan the SYSTEM and SYSAUX Tablespaces](#)  
There is a separate `SYSAUX` and `SYSTEM` tablespace for the CDB root and for each PDB.

- [Plan the Temporary Tablespaces](#)  
Plan to use default temporary tablespaces.
- [Choose the Undo Mode](#)  
Plan to use an undo tablespace to manage your undo data.
- [Plan the Services for Your Application](#)  
Plan for the database services required to meet the needs of your applications.
- [Learn How to Start Up and Shut Down a CDB](#)  
Familiarize yourself with the principles and options of starting up and shutting down a database instance and mounting and opening a CDB.
- [Plan for Oracle RAC](#)  
If you plan to use Oracle RAC, then plan for an Oracle RAC environment.

### 4.2.1.1 Plan the PDBs

Plan the tables and indexes for the pluggable databases (PDBs) and estimate the amount of space they require.

In a CDB, most user data resides in the PDBs. The root contains no user data or minimal user data. Plan for the PDBs that will be part of the CDB. The disk storage space requirement for a CDB is the space required for the Oracle Database installation plus the sum of the space requirements for all PDBs that will be part of the CDB.

The `MAX_PDBS` initialization parameter specifies a limit on the total number of PDBs that you can create in a CDB root or application root. The default value and maximum value for `MAX_PDBS` depend on your Oracle Database offering. See *Oracle Database Licensing Information User Manual* for details on which features are supported for different editions and services.

You can also create application containers in a CDB. An application container is a collection of application PDBs that store the data for one or more applications. In addition, application containers support user-created application common objects that can be shared by the application PDBs in the application container.

#### See Also:

- ["Creating and Removing PDBs and Application Containers"](#)
- ["Overview of Applications in an Application Container"](#)
- *Oracle Database Administrator's Guide* to learn more about database structure and storage and schema objects
- *Oracle Database Reference* to learn more about `MAX_PDBS`

### 4.2.1.2 Plan the Physical Layout

Plan the layout of the underlying operating system files your CDB will comprise.

There are separate data files for the CDB root, `PDB$SEED`, each PDB, each application root, and each application PDB.

There is one redo log for a single-instance CDB, or one redo log for each instance of an Oracle Real Application Clusters (Oracle RAC) CDB. Also, for Oracle RAC, all data files and redo log files must be on shared storage.

#### See Also:

- *Oracle Database Administrator's Guide* for information about using Oracle Managed Files
- *Oracle Automatic Storage Management Administrator's Guide*
- *Oracle Database Performance Tuning Guide*
- *Oracle Database Backup and Recovery User's Guide*
- *Oracle Grid Infrastructure Installation and Upgrade Guide* for information about configuring storage for Oracle RAC
- Your Oracle operating system–specific documentation, including the appropriate Oracle Database installation guide.

### 4.2.1.3 Learn How to Manage Initialization Parameters

Familiarize yourself with the initialization parameters that can be included in an initialization parameter file.

Before creating a CDB, ensure that you are familiar with the concept and operation of a server parameter file (SPFILE). An SPFILE file lets you store and manage your initialization parameters persistently in a server-side binary file.

A CDB uses a single SPFILE or a single text initialization parameter file (PFILE). Values of initialization parameters set for the root can be inherited by PDBs. You can set some initialization parameters for a PDB by using the `ALTER SYSTEM` statement.

The CDB root must be the current container when you operate on an SPFILE. The user who creates or modifies the SPFILE must be a common user with `SYSDBA`, `SYSOPER`, or `SYSBACKUP` administrative privilege, and the user must exercise the privilege by connecting `AS SYSDBA`, `AS SYSOPER`, or `AS SYSBACKUP` respectively.

The following initialization parameters are important:

- To create a CDB, the `ENABLE_PLUGGABLE_DATABASE` initialization parameter must be set to `TRUE`.
- Create the global database name for the CDB root by setting both the `DB_NAME` and `DB_DOMAIN` initialization parameters. The global database name of the root is the global database name of the CDB. The global database name of a PDB is defined by the PDB name and the `DB_DOMAIN` initialization parameter.

 **See Also:**

- ["About the Current Container"](#)
- ["Modifying a CDB with ALTER SYSTEM"](#)
- ["Listing the Modifiable Initialization Parameters in PDBs"](#)
- *Oracle Database Administrator's Guide* for information about schema objects
- *Oracle Database Administrator's Guide* for information about determining the global database name
- *Oracle Database Reference*

#### 4.2.1.4 Select the Character Set

You must choose a character set for the CDB.

When selecting the database character set for the CDB, you must consider the current character sets of the databases that you want to consolidate (plug) into this CDB. Oracle recommends AL32UTF8 for the CDB database character set and AL16UTF6 for the CDB national character set because they provide the most flexibility.

When the character set of the CDB root is AL32UTF8, PDBs that are plugged into the CDB can have a different character set from the CDB root. PDBs that are created from `PDB$SEED` inherit the AL32UTF8 character set from it, but you can migrate the PDB to a different character set. When the character set of the root is not AL32UTF8, all PDBs in the CDB use the character set of the CDB root.

When moving a non-CDB to a CDB, it is best to migrate the non-CDB to AL32UTF8 first. You can use Oracle Database Migration Assistant for Unicode (DMU) to migrate a non-CDB to AL32UTF8. After a CDB is created, you cannot migrate the character set of the CDB using DMU.

 **See Also:**

*Oracle Database Globalization Support Guide*

#### 4.2.1.5 Decide Which Time Zones to Support

Consider which time zones your CDB must support.

You can set the time zones for the entire CDB (including all PDBs). You can also set the time zones individually for each PDB.

 **See Also:**

*Oracle Database Administrator's Guide* for information about specifying the database time zone and time zone file

### 4.2.1.6 Select the Database and Redo Log Block Sizes

Select the standard database block size for the CDB.

This is specified at CDB creation by the `DB_BLOCK_SIZE` initialization parameter and cannot be changed after the CDB is created. The standard block size applies to the entire CDB.

If you plan to store online redo log files on disks with a 4K byte sector size, then determine whether you must manually specify the online redo log block size.

- *Oracle Database Administrator's Guide* for information about specifying database block sizes
- *Oracle Database Administrator's Guide* for information about planning the block size of redo log files

### 4.2.1.7 Plan the SYSTEM and SYSAUX Tablespaces

There is a separate `SYSAUX` and `SYSTEM` tablespace for the CDB root and for each PDB.

You must determine the appropriate initial sizing for the `SYSAUX` tablespace. Also, plan to use a default tablespace for non-`SYSTEM` users to prevent inadvertently saving database objects in the `SYSTEM` tablespace. You can specify a separate default tablespace for the CDB root and for each PDB.

 **See Also:**

- *Oracle Database Administrator's Guide* for information about the `SYSAUX` tablespace
- *Oracle Database Administrator's Guide* for information about creating a default permanent tablespace
- ["About Container Modification When Connected to CDB Root"](#)

### 4.2.1.8 Plan the Temporary Tablespaces

Plan to use default temporary tablespaces.

A default temporary tablespace exists for every container in the CDB. Therefore, the CDB root and every PDB, application root, and application PDB has its own default temporary tablespace.

Oracle Database uses the shared temporary tablespace for recursive SQL only. Hosted PDB tenants do not use this tablespace directly.

 **See Also:**

- ["About Container Modification When Connected to CDB Root"](#)
- *Oracle Database Administrator's Guide* for information about creating a default temporary tablespace

### 4.2.1.9 Choose the Undo Mode

Plan to use an undo tablespace to manage your undo data.

A CDB can run in different undo modes. You can configure a CDB to have one active undo tablespace for the entire CDB or a separate undo tablespace for each container in the CDB. You can specify the undo mode during CDB creation, and you can change the undo mode after the CDB is created.

When you choose to have one active undo tablespace for the entire CDB, shared undo is used, and local undo is disabled. In this configuration, there is one active undo tablespace for a single-instance CDB. When local undo is enabled, there is one undo tablespace for each container in a single instance configuration. For an Oracle RAC CDB, each PDB has one undo tablespace in each node in which it is open. With shared undo, only a common user who has the appropriate privileges and whose current container is the root can create an undo tablespace.

The best practice is to use local undo for a CDB. Shared undo is supported primarily for upgrade and transitional purposes only. Although there is minor overhead associated with local undo when compared with shared undo, the benefits of local undo make it preferable in most environments. Local undo makes unplug operations and point in time recovery faster, and it is required for some features, such as relocating a PDB. By default, DBCA creates new CDBs with local undo enabled.

In a CDB, the `UNDO_MANAGEMENT` initialization parameter must be set to `AUTO`, and an undo tablespace is required to manage the undo data.

When local undo is not enabled, undo tablespaces are visible in static data dictionary views and dynamic performance (V\$) views when the current container is the root. Undo tablespaces are visible only in dynamic performance views when the current container is a PDB.

Also, when local undo is disabled, Oracle Database silently ignores undo tablespace and rollback segment operations when the current container is a PDB.

 **See Also:**

- ["Setting the Undo Mode in a CDB Using ALTER DATABASE"](#)
- ["About the Current Container"](#)
- *Oracle Database Administrator's Guide* for information about managing undo



### 4.2.1.10 Plan the Services for Your Application

Plan for the database services required to meet the needs of your applications.

The root and each PDB might require several services. You can create services for the root or for individual PDBs.

Database services have an optional `PDB` property. You can create services and associate them with a particular PDB by specifying the `PDB` property. Services with a null `PDB` property are associated with the CDB root.

You can also use the `DBMS_SERVICE` supplied PL/SQL package to create services and associate them with PDBs. When you run `CREATE_SERVICE` procedure, the service is associated with the current container.

You can manage services with the `SRVCTL` utility, Oracle Enterprise Manager Cloud Control, and the `DBMS_SERVICE` supplied PL/SQL package.

When you create a PDB, a new default service for the PDB is created automatically. The service has the same name as the PDB. You cannot manage this service with the `SRVCTL` utility. However, you can create user-defined services and customize them for your applications.

#### See Also:

- ["Managing Services for PDBs"](#)
- *Oracle Database Administrator's Guide* to learn about database services and using `SRVCTL` with a single-instance database
- *Oracle Real Application Clusters Administration and Deployment Guide* for information about using the `SRVCTL` utility with an Oracle RAC database

### 4.2.1.11 Learn How to Start Up and Shut Down a CDB

Familiarize yourself with the principles and options of starting up and shutting down a database instance and mounting and opening a CDB.

In a CDB, the CDB root and all containers share a single database instance, or, when using Oracle RAC, multiple concurrent instances. You can start up and shut down an entire CDB, which in turn determines the state of hosted PDBs. When the CDB is open, you can control the open mode of PDBs by using either an `ALTER PLUGGABLE DATABASE` statement in the context of the CDB or PDB to open or close hosted PDBs. To maintain backward compatibility, `ALTER DATABASE OPEN` and `ALTER DATABASE CLOSE` statements are supported when they are executed and a PDB is the current container. You can also use the SQL\*Plus `STARTUP` command and the SQL\*Plus `SHUTDOWN` command when a PDB is the current container. However, the SQL\*Plus `STARTUP MOUNT` command is a CDB-only operation and cannot be used when a PDB is the current container.

 **See Also:**

- ["Modifying the Open Mode of One or More PDBs"](#)
- ["Modifying a PDB with the ALTER PLUGGABLE DATABASE Statement"](#)
- *Oracle Database Administrator's Guide* for information about starting up a database

### 4.2.1.12 Plan for Oracle RAC

If you plan to use Oracle RAC, then plan for an Oracle RAC environment.

The Oracle RAC documentation describes special considerations for a CDB in an Oracle RAC environment. See your platform-specific Oracle RAC installation guide for information about creating a CDB in an Oracle RAC environment.

 **See Also:**

*Oracle Real Application Clusters Administration and Deployment Guide*

## 4.2.2 Prerequisites for CDB Creation

You must complete prerequisites before creating a new CDB.

Before you can create a new CDB, the following prerequisites must be met:

- Ensure that the prerequisites described in ["Prerequisites for a Multitenant Environment"](#) are met.
- Sufficient memory must be available to start the Oracle Database instance.  
Size the memory required by a CDB to accommodate the workload of each of its containers and the number of containers.
- Sufficient disk storage space must be available for the planned PDBs on the computer that runs Oracle Database. In an Oracle RAC environment, sufficient shared storage must be available.

The disk storage space required by a CDB is the sum of the space requirements for all PDBs that will reside in the CDB.

These prerequisites are discussed in the *Oracle Database Installation Guide* or *Oracle Grid Infrastructure Installation and Upgrade Guide* specific to your operating system. If you use the Oracle Universal Installer, then it will guide you through your installation and provide help in setting environment variables and establishing directory structure and authorizations.

## 4.3 Creating a CDB

You can create a CDB using DBCA or by manually issuing the `CREATE DATABASE SQL` statement.

 **Note:**

Oracle strongly recommends using the Database Configuration Assistant (DBCA) template deployment instead of the `CREATE DATABASE SQL` statement to create a CDB, because using DBCA is a more automated approach, and your CDB is ready to use when DBCA completes.

This section contains the following topics:

- [About CDB Creation with DBCA](#)  
Oracle strongly recommends using the Database Configuration Assistant (DBCA) to create a CDB.
- [About CDB Creation with SQL Statements](#)  
Creating a CDB using the `CREATE DATABASE SQL` statement is similar to creating a non-CDB.
- [Creating a CDB with the CREATE DATABASE Statement](#)  
When you use the `CREATE DATABASE` statement to create a CDB, you must complete additional actions before you have an operational CDB.
- [Creating a CDB with the CREATE DATABASE Statement: Examples](#)  
These examples create a CDB named `newcdb`.

## 4.3.1 About CDB Creation with DBCA

Oracle strongly recommends using the Database Configuration Assistant (DBCA) to create a CDB.

DBCA offers the following advantages over alternative techniques:

- Creation is largely automated.
- DBCA enables you to specify the number of PDBs in the CDB when it is created.
- When DBCA completes, the CDB is ready to use.
- After a CDB is created, you can use DBCA to do the following:
  - Clone local PDBs
  - Plug in and unplug PDBs
  - Duplicate a CDB (silent mode only)

Depending on the type of install that you select, Oracle Universal Installer (OUI) can launch DBCA. You can also launch DBCA as a standalone tool at any time after Oracle Database installation.

You can use DBCA to create a CDB in either of the following modes:

- Interactive mode  
This mode provides a graphical interface and guided workflow for creating and configuring a CDB.
- Noninteractive mode (also called *silent mode*)

This mode enables you to script a preconfigured CDB template deployment with customized PDB seed databases that are suitable for cloning. Run DBCA in silent mode by specifying command-line arguments, a response file, or both.

 **See Also:**

- *Oracle Database Administrator's Guide* to learn how to create a database with DBCA
- *Oracle Database 2 Day DBA*
- The DBCA online help

## 4.3.2 About CDB Creation with SQL Statements

Creating a CDB using the `CREATE DATABASE` SQL statement is similar to creating a non-CDB.

This section describes additional requirements for creating a CDB. When you create a CDB using `CREATE DATABASE`, you must do the following:

- Enable PDBs
- Specify the names and locations of the CDB root files
- Specify the names and locations of the `PDB$SEED` files

 **Note:**

Using the `CREATE DATABASE` SQL statement is a more manual approach to creating a CDB than using DBCA.

This section contains the following topics:

- [About Enabling PDBs](#)  
To create a CDB, the `CREATE DATABASE` statement must include the `ENABLE PLUGGABLE DATABASE` clause.
- [About the Names and Locations of the Files for Root and the PDB Seed](#)  
The `CREATE DATABASE` statement uses the root files (such as data files) to generate the names of the files for `PDB$SEED`.
- [About the Attributes of the Data Files for PDB\\$SEED](#)  
You can use the PDB seed (`PDB$SEED`) as a template to create new containers.
- [About the CDB Undo Mode](#)  
Add the `undo_mode_clause` to an `ENABLE PLUGGABLE DATABASE` clause to specify the undo mode of the CDB.

**See Also:**

*Oracle Database Concepts* for information about the files in a CDB

### 4.3.2.1 About Enabling PDBs

To create a CDB, the `CREATE DATABASE` statement must include the `ENABLE PLUGGABLE DATABASE` clause.

This clause affects the `CREATE DATABASE` statement as follows:

- `ENABLE PLUGGABLE DATABASE` is included  
The statement creates a CDB with the root and `PDB$SEED`. You can never change the CDB into a non-CDB.
- `ENABLE PLUGGABLE DATABASE` is not included  
The newly created database is a non-CDB, which means that it does not include the CDB root or `PDB$SEED`. The non-CDB can never contain PDBs.

### 4.3.2.2 About the Names and Locations of the Files for Root and the PDB Seed

The `CREATE DATABASE` statement uses the root files (such as data files) to generate the names of the files for `PDB$SEED`.

You must specify the names and locations of the files for root and `PDB$SEED`. After the `CREATE DATABASE` statement completes successfully, you can use `PDB$SEED` and its files to create new PDBs. You cannot modify the PDB seed after it is created.

You must specify the names and locations of the files for `PDB$SEED` in one of the following ways:

1. The `SEED FILE_NAME_CONVERT` clause
2. Oracle Managed Files
3. The `PDB_FILE_NAME_CONVERT` initialization parameter

If you use more than technique, then the `CREATE DATABASE` statement uses one technique in the order of precedence of the preceding list. For example, if you use all techniques, then the `CREATE DATABASE` statement only uses the specifications in the `SEED FILE_NAME_CONVERT` clause because it is first in the list.

This section contains the following topics:

- [The `SEED FILE\_NAME\_CONVERT` Clause](#)  
The `SEED FILE_NAME_CONVERT` clause of the `CREATE DATABASE` statement specifies how to generate the names of the `PDB$SEED` files using the names of the CDB root files.
- [Oracle Managed Files](#)  
When Oracle Managed Files is enabled, it can determine the names and locations of the `PDB$SEED` files.

- [The PDB\\_FILE\\_NAME\\_CONVERT Initialization Parameter](#)  
The `PDB_FILE_NAME_CONVERT` initialization parameter can specify the names and locations of the seed's files.

**See Also:**

["Creating a PDB from Scratch"](#)

#### 4.3.2.2.1 The SEED FILE\_NAME\_CONVERT Clause

The `SEED FILE_NAME_CONVERT` clause of the `CREATE DATABASE` statement specifies how to generate the names of the `PDB$SEED` files using the names of the CDB root files.

You can use this clause to specify one of the following options:

- One or more file name patterns and replacement file name patterns, in the following form:

```
'string1' , 'string2' , 'string3' , 'string4' , ...
```

The *string2* file name pattern replaces the *string1* file name pattern, and the *string4* file name pattern replaces the *string3* file name pattern. You can use as many pairs of file name pattern and replacement file name pattern strings as required.

If you specify an odd number of strings (the last string has no corresponding replacement string), then an error is returned. Do not specify more than one pattern/replace string that matches a single file name or directory.

File name patterns cannot match files or directories managed by Oracle Managed Files.

- `NONE` when no file names should be converted. Omitting the `SEED FILE_NAME_CONVERT` clause is the same as specifying `NONE`.

#### Example 4-1 SEED FILE\_NAME\_CONVERT Clause

This `SEED FILE_NAME_CONVERT` clause generates file names for the `PDB$SEED` files in the `/oracle/pdbseed/` directory using file names in the `/oracle/dbs` directory.

```
SEED FILE_NAME_CONVERT = ('/oracle/dbs/', '/oracle/pdbseed/')
```

**See Also:**

*Oracle Database SQL Language Reference* for the syntax of the `SEED FILE_NAME_CONVERT` clause

### 4.3.2.2 Oracle Managed Files

When Oracle Managed Files is enabled, it can determine the names and locations of the `PDB$SEED` files.



#### See Also:

*Oracle Database Administrator's Guide*

### 4.3.2.2.3 The `PDB_FILE_NAME_CONVERT` Initialization Parameter

The `PDB_FILE_NAME_CONVERT` initialization parameter can specify the names and locations of the seed's files.

To use this technique, ensure that the `PDB_FILE_NAME_CONVERT` initialization parameter is included in the initialization parameter file when you create the CDB.

File name patterns specified in this initialization parameter cannot match files or directories managed by Oracle Managed Files.



#### See Also:

*Oracle Database Reference*

### 4.3.2.3 About the Attributes of the Data Files for `PDB$SEED`

You can use the PDB seed (`PDB$SEED`) as a template to create new containers.

The attributes of the data files for the CDB root `SYSTEM` and `SYSAUX` tablespaces might not be suitable for the PDB seed. In this case, you can specify different attributes for the PDB seed data files by using the `tablespace_datafile` clauses. Use these clauses to specify attributes for all data files comprising the `SYSTEM` and `SYSAUX` tablespaces in the PDB seed. The values inherited from the root are used for any attributes whose values have not been provided.

The syntax of the `tablespace_datafile` clauses is the same as the syntax for a data file specification, excluding the name and location of the data file and the `REUSE` attribute. You can use the `tablespace_datafile` clauses with any of the methods for specifying the names and locations of the PDB seed's data files described in "[About the Names and Locations of the Files for Root and the PDB Seed](#)".

The `tablespace_datafile` clauses do not specify the names and locations of the PDB seed's data files. Instead, they specify the attributes of `SYSTEM` and `SYSAUX` data files in the PDB seed that differ from those in the root. If `SIZE` is not specified in the `tablespace_datafile` clause for a tablespace, then data file size for the tablespace is set to a predetermined fraction of the size of a corresponding root data file.

### Example 4-2 Using the `tablespace_datafile` Clauses

Assume the following `CREATE DATABASE` clauses specify the names, locations, and attributes of the data files that comprise the `SYSTEM` and `SYSAUX` tablespaces in the root.

```
DATAFILE '/u01/app/oracle/oradata/newcdb/system01.dbf' SIZE 325M REUSE
SYSAUX DATAFILE '/u01/app/oracle/oradata/newcdb/sysaux01.dbf' SIZE 325M
REUSE
```

You can use the following `tablespace_datafile` clauses to specify different attributes for these data files:

```
SEED
  SYSTEM DATAFILES
    SIZE 125M AUTOEXTEND ON NEXT 10M MAXSIZE UNLIMITED
  SYSAUX DATAFILES
    SIZE 100M
```

In this example, the data files for the PDB seed's `SYSTEM` and `SYSAUX` tablespaces inherit the `REUSE` attribute from the root's data files. However, the following attributes of the PDB seed's data files differ from the root's:

- The data file for the `SYSTEM` tablespace is 125 MB for the PDB seed and 325 MB for the root.
- `AUTOEXTEND` is enabled for the PDB seed's `SYSTEM` data file, and it is disabled by default for the root's `SYSTEM` data file.
- The data file for the `SYSAUX` tablespace is 100 MB for the PDB seed and 325 MB for the root.



#### See Also:

*Oracle Database SQL Language Reference* for information about data file specifications

### 4.3.2.4 About the CDB Undo Mode

Add the `undo_mode_clause` to an `ENABLE PLUGGABLE DATABASE` clause to specify the undo mode of the CDB.

The `undo_mode_clause` specifies whether the CDB undo mode is local or shared. Local undo mode means that every container in the CDB uses local undo. To configure local undo mode for the CDB, specify `LOCAL UNDO ON`. Shared undo mode means that there is one active undo tablespace for a single-instance CDB, or for an Oracle RAC CDB, there is one active undo tablespace for each instance. To configure shared undo mode for the CDB, specify `LOCAL UNDO OFF`. If the `undo_mode_clause` is not added to the `ENABLE PLUGGABLE DATABASE` clause, then shared undo mode is the default.



### 4.3.3 Creating a CDB with the CREATE DATABASE Statement

When you use the `CREATE DATABASE` statement to create a CDB, you must complete additional actions before you have an operational CDB.

These actions include building views on the data dictionary tables and installing standard PL/SQL packages in the root. Perform these actions by running the supplied `catcdb.sql` script, which installs all components required by a CDB.

#### Prerequisites

Note the following prerequisites:

- The instructions in this section apply to *single-instance database installations only*. See the Oracle Real Application Clusters (Oracle RAC) installation guide for your platform for instructions for creating an Oracle RAC CDB.
- If you are using Oracle ASM to manage your disk storage, then you must start the Oracle ASM instance and configure your disk groups before performing these steps.
- The `ENABLE_PLUGGABLE_DATABASE` initialization parameter must be set to `true`.

#### To create a CDB with the CREATE DATABASE statement:

1. Complete steps 1 - 8 in the “Creating a Database with the `CREATE DATABASE` Statement” topic in *Oracle Database Administrator’s Guide*.

In a CDB, the `DB_NAME` initialization parameter specifies the name of the root. Also, it is common practice to set the `SID` to the name of the root. The maximum number of characters for this name is 30. For more information, see the discussion of the `DB_NAME` initialization parameter in *Oracle Database Reference*.

2. Use the `CREATE DATABASE` statement to create a new CDB.

See the examples in ["Creating a CDB Using Oracle Managed Files: Example"](#) and ["Creating a CDB Without Using Oracle Managed Files"](#).

#### Tip:

If your `CREATE DATABASE` statement fails, and if you did not complete Step 7 in the “Creating a Database with the `CREATE DATABASE` Statement” topic in *Oracle Database Administrator’s Guide*, then ensure that there is not a preexisting server parameter file (SPFILE) for this instance that is setting initialization parameters in an unexpected way. For example, an SPFILE contains a setting for the complete path to all control files, and the `CREATE DATABASE` statement fails if those control files do not exist. Ensure that you shut down and restart the instance (with `STARTUP NOMOUNT`) after removing an unwanted SPFILE.

3. Run the `catcdb.sql` SQL script.

Enter the following in SQL\*Plus to run the script:

```
@?/rdbms/admin/catcdb.sql
```

4. When prompted by the script, enter the log file directory for parameter 1 and the log file name for parameter 2.

For following example enters `/tmp` for the first prompt and `create_cdb.log` for the second prompt:

```
SQL> host perl -I &&rdbms_admin &&rdbms_admin_catcdb --logDirectory &&1
--logFilename &&2
Enter value for 1: /tmp
Enter value for 2: create_cdb.log
```

5. When prompted by the script, enter any other required information.

For example, the scripts prompts for administrator passwords and the temporary tablespace name:

```
Enter new password for SYS: *****
Enter new password for SYSTEM: *****
Enter temporary tablespace name: TEMP
```

6. After `catcdb.sql` completes, perform steps 12 - 14 in the “Creating a Database with the `CREATE DATABASE` Statement” topic in *Oracle Database Administrator's Guide*.

#### See Also:

- *Oracle Database Administrator's Guide* to learn more about `CREATE DATABASE` clauses and Oracle Managed Files
- *Oracle Real Application Clusters Administration and Deployment Guide* for more information on Oracle RAC
- *Oracle Automatic Storage Management Administrator's Guide*
- *Oracle Database SQL Language Reference* to learn more about the clauses and parameter values for the `CREATE DATABASE` statement

## 4.3.4 Creating a CDB with the `CREATE DATABASE` Statement: Examples

These examples create a CDB named `newcdb`.

The examples assume that you completed steps 1 - 8 in the “Creating a Database with the `CREATE DATABASE` Statement” topic in *Oracle Database Administrator's Guide*.

This section contains the following topics:

- [Creating a CDB Without Using Oracle Managed Files](#)  
The following statement creates a CDB named `newcdb`. This name must agree with the `DB_NAME` parameter in the initialization parameter file.
- [Creating a CDB Using Oracle Managed Files: Example](#)  
This example illustrates creating a CDB with Oracle Managed Files, which enables you to use a much simpler `CREATE DATABASE` statement.

### 4.3.4.1 Creating a CDB Without Using Oracle Managed Files

The following statement creates a CDB named `newcdb`. This name must agree with the `DB_NAME` parameter in the initialization parameter file.

#### Assumptions

This example assumes the following:

- The initialization parameter file specifies the number and location of control files with the `CONTROL_FILES` parameter.
- The directory `/u01/app/oracle/oradata/newcdb` exists.
- The directory `/u01/app/oracle/oradata/pdbseed` exists.
- The directories `/u01/logs/my` and `/u02/logs/my` exist.

This example includes the `ENABLE PLUGGABLE DATABASE` clause to create a CDB with the root and the PDB seed. This example also includes the `SEED FILE_NAME_CONVERT` clause to specify the names and locations of the PDB seed's files. This example also includes `tablespace_datafile` clauses that specify attributes of the PDB seed data files for the `SYSTEM` and `SYSAUX` tablespaces that differ from the root data files. This example includes the `undo_mode_clause` to specify that the CDB undo mode is local.

```
CREATE DATABASE newcdb
  USER SYS IDENTIFIED BY sys_password
  USER SYSTEM IDENTIFIED BY system_password
  LOGFILE GROUP 1 ('/u01/logs/my/redo01a.log', '/u02/logs/my/redo01b.log')
    SIZE 100M BLOCKSIZE 512,
    GROUP 2 ('/u01/logs/my/redo02a.log', '/u02/logs/my/redo02b.log')
    SIZE 100M BLOCKSIZE 512,
    GROUP 3 ('/u01/logs/my/redo03a.log', '/u02/logs/my/redo03b.log')
    SIZE 100M BLOCKSIZE 512
  MAXLOGHISTORY 1
  MAXLOGFILES 16
  MAXLOGMEMBERS 3
  MAXDATAFILES 1024
  CHARACTER SET AL32UTF8
  NATIONAL CHARACTER SET AL16UTF16
  EXTENT MANAGEMENT LOCAL
  DATAFILE '/u01/app/oracle/oradata/newcdb/system01.dbf'
    SIZE 700M REUSE AUTOEXTEND ON NEXT 10240K MAXSIZE UNLIMITED
  SYSAUX DATAFILE '/u01/app/oracle/oradata/newcdb/sysaux01.dbf'
    SIZE 550M REUSE AUTOEXTEND ON NEXT 10240K MAXSIZE UNLIMITED
  DEFAULT TABLESPACE deftbs
    DATAFILE '/u01/app/oracle/oradata/newcdb/deftbs01.dbf'
    SIZE 500M REUSE AUTOEXTEND ON MAXSIZE UNLIMITED
  DEFAULT TEMPORARY TABLESPACE tempts1
    TEMPFILE '/u01/app/oracle/oradata/newcdb/temp01.dbf'
    SIZE 20M REUSE AUTOEXTEND ON NEXT 640K MAXSIZE UNLIMITED
  UNDO TABLESPACE undotbs1
    DATAFILE '/u01/app/oracle/oradata/newcdb/undotbs01.dbf'
    SIZE 200M REUSE AUTOEXTEND ON NEXT 5120K MAXSIZE UNLIMITED
  ENABLE PLUGGABLE DATABASE
  SEED
```

```
FILE_NAME_CONVERT = ('/u01/app/oracle/oradata/newcdb/',  
                    '/u01/app/oracle/oradata/pdbseed/')  
SYSTEM DATAFILES SIZE 125M AUTOEXTEND ON NEXT 10M MAXSIZE UNLIMITED  
SYSaux DATAFILES SIZE 100M  
USER_DATA TABLESPACE usertbs  
  DATAFILE '/u01/app/oracle/oradata/pdbseed/usertbs01.dbf'  
  SIZE 200M REUSE AUTOEXTEND ON MAXSIZE UNLIMITED  
LOCAL UNDO ON;
```

A CDB is created with the following characteristics:

- The CDB is named `newcdb`. Its global database name is `newcdb.us.example.com`, where the domain portion (`us.example.com`) is taken from the initialization parameter file. See *Oracle Database Administrator's Guide* for information about determining the global database name.
- Three control files are created as specified by the `CONTROL_FILES` initialization parameter, which was set before CDB creation in the initialization parameter file. See *Oracle Database Administrator's Guide* for a sample initialization parameter file and *Oracle Database Administrator's Guide* for information about specifying control files.
- The passwords for user accounts `SYS` and `SYSTEM` are set to the values that you specified. The passwords are case-sensitive. The two clauses that specify the passwords for `SYS` and `SYSTEM` are not mandatory in this release of Oracle Database. However, if you specify either clause, then you must specify both clauses. For further information about the use of these clauses, see *Oracle Database Administrator's Guide* for information about specifying passwords for users `SYS` and `SYSTEM`.
- The new CDB has three online redo log file groups, each with two members, as specified in the `LOGFILE` clause. `MAXLOGFILES`, `MAXLOGMEMBERS`, and `MAXLOGHISTORY` define limits for the redo log. See *Oracle Database Administrator's Guide* for information about choosing the number of redo log files. The block size for the redo logs is set to 512 bytes, the same size as physical sectors on disk. The `BLOCKSIZE` clause is optional if block size is to be the same as physical sector size (the default). Typical sector size and thus typical block size is 512. Permissible values for `BLOCKSIZE` are 512, 1024, and 4096. For newer disks with a 4K sector size, optionally specify `BLOCKSIZE` as 4096. See *Oracle Database Administrator's Guide* for more information about planning the block size of redo log files.
- `MAXDATAFILES` specifies the maximum number of data files that can be open in the CDB. This number affects the initial sizing of the control file. For a CDB, set `MAXDATAFILES` to a high number that anticipates the aggregate number of data files for all containers, in addition to the CDB root files.

 **Note:**

You can set several limits during CDB creation. Some of these limits are limited by and affected by operating system limits. For example, if you set `MAXDATAFILES`, then Oracle Database allocates enough space in the control file to store `MAXDATAFILES` file names, even if the CDB has only one data file initially. However, because the maximum control file size is limited and operating system dependent, you might not be able to set all `CREATE DATABASE` parameters at their theoretical maximums.

For more information about setting limits during CDB creation, see the *Oracle Database SQL Language Reference* and your operating system-specific Oracle documentation.

- The `AL32UTF8` character set is used to store data in this CDB.
- The `AL16UTF16` character set is specified as the `NATIONAL CHARACTER SET` used to store data in columns specifically defined as `NCHAR`, `NCLOB`, or `NVARCHAR2`.
- The `SYSTEM` tablespace, consisting of the operating system file `/u01/app/oracle/oradata/newcdb/system01.dbf`, is created as specified by the `DATAFILE` clause. If a file with that name already exists, then it is overwritten.
- The `SYSTEM` tablespace is created as a locally managed tablespace. See *Oracle Database Administrator's Guide* for information about creating a locally managed `SYSTEM` tablespace.
- A `SYSAUX` tablespace is created, consisting of the operating system file `/u01/app/oracle/oradata/newcdb/sysaux01.dbf` as specified in the `SYSAUX DATAFILE` clause. See *Oracle Database Administrator's Guide* for information about the `SYSAUX` tablespace.
- The `DEFAULT TABLESPACE` clause creates and names a default permanent tablespace for this CDB.
- The `DEFAULT TEMPORARY TABLESPACE` clause creates and names a default temporary tablespace for the root of this CDB. See *Oracle Database Administrator's Guide* for information about creating a default temporary tablespace.
- The `UNDO TABLESPACE` clause creates and names an undo tablespace that is used to store undo data for this CDB. In a CDB, an undo tablespace is required to manage the undo data, and the `UNDO_MANAGEMENT` initialization parameter must be set to `AUTO`. If you omit this parameter, then it defaults to `AUTO`. See *Oracle Database Administrator's Guide* for information about creating an undo tablespace.
- Redo log files will not initially be archived, because the `ARCHIVELOG` clause is not specified in this `CREATE DATABASE` statement. This is customary during CDB creation. You can later use an `ALTER DATABASE` statement to switch to `ARCHIVELOG` mode. The initialization parameters in the initialization parameter file for `newcdb` relating to archiving are `LOG_ARCHIVE_DEST_1` and `LOG_ARCHIVE_FORMAT`. See *Oracle Database Administrator's Guide* for information about managing archived redo log files.
- The `ENABLE PLUGGABLE DATABASE` clause creates a CDB with the root and the PDB seed.

- `SEED` is required for the `FILE_NAME_CONVERT` clause and the `tablespace_datafile` clauses.
- The `FILE_NAME_CONVERT` clause generates file names for the PDB seed's files in the `/u01/app/oracle/oradata/pdbseed` directory using file names in the `/u01/app/oracle/oradata/newcdb` directory.
- The `SYSTEM DATAFILES` clause specifies attributes of the PDB seed `SYSTEM` tablespace data file(s) that differ from the root's.
- The `SYSAUX DATAFILES` clause specifies attributes of the PDB seed `SYSAUX` tablespace data file(s) that differ from the root's.
- The `USER_DATA TABLESPACE` clause creates and names the PDB seed's tablespace for storing user data and database options such as Oracle XML DB. PDBs created using the PDB seed include this tablespace and its data file. The tablespace and data file specified in this clause are not used by the root.
- The `LOCAL UNDO ON` clause sets the CDB undo mode to local, which means that each container in the CDB uses local undo.

When the CDB is created in local undo mode, the PDB seed includes an undo tablespace so that any new PDB created from the PDB seed has an undo tablespace. When a PDB is created by plugging it in or cloning a remote PDB, and the source PDB was in shared undo mode, an undo tablespace is created for the PDB automatically the first time the PDB is opened.

 **Note:**

- Ensure that all directories used in the `CREATE DATABASE` statement exist. The `CREATE DATABASE` statement does not create directories.
- If you are not using Oracle Managed Files, then every tablespace clause must include a `DATAFILE` or `TEMPFILE` clause.
- If CDB creation fails, then you can look at the alert log to determine the reason for the failure and to determine corrective actions. See *Oracle Database Administrator's Guide* for information about viewing the alert log. If you receive an error message that contains a process number, then examine the trace file for that process. Look for the trace file that contains the process number in the trace file name. See *Oracle Database Administrator's Guide* for more information.
- To resubmit the `CREATE DATABASE` statement after a failure, you must first shut down the instance and delete any files created by the previous `CREATE DATABASE` statement.

#### 4.3.4.2 Creating a CDB Using Oracle Managed Files: Example

This example illustrates creating a CDB with Oracle Managed Files, which enables you to use a much simpler `CREATE DATABASE` statement.

To use Oracle Managed Files, the initialization parameter `DB_CREATE_FILE_DEST` must be set. This parameter defines the base directory for the various CDB files that the CDB creates and automatically names.

The following statement is an example of setting this parameter in the initialization parameter file:

```
DB_CREATE_FILE_DEST='/u01/app/oracle/oradata'
```

This example sets the parameter Oracle ASM storage:

```
DB_CREATE_FILE_DEST = +data
```

This example includes the `ENABLE PLUGGABLE DATABASE` clause to create a CDB with the root and the PDB seed. This example does not include the `SEED FILE_NAME_CONVERT` clause because Oracle Managed Files determines the names and locations of the PDB seed's files. However, this example does include `tablespace_datafile` clauses that specify attributes of the PDB seed data files for the `SYSTEM` and `SYSAUX` tablespaces that differ from the root data files.

With Oracle Managed Files and the following `CREATE DATABASE` statement, the CDB creates the `SYSTEM` and `SYSAUX` tablespaces, creates the additional tablespaces specified in the statement, and chooses default sizes and properties for all data files, control files, and redo log files. Note that these properties and the other default CDB properties set by this method might not be suitable for your production environment, so it is recommended that you examine the resulting configuration and modify it if necessary.

```
CREATE DATABASE newcdb
USER SYS IDENTIFIED BY sys_password
USER SYSTEM IDENTIFIED BY system_password
EXTENT MANAGEMENT LOCAL
DEFAULT TABLESPACE users
DEFAULT TEMPORARY TABLESPACE temp
UNDO TABLESPACE undotbs1
ENABLE PLUGGABLE DATABASE
  SEED
    SYSTEM DATAFILES SIZE 125M AUTOEXTEND ON NEXT 10M MAXSIZE UNLIMITED
    SYSAUX DATAFILES SIZE 100M;
```

A CDB is created with the following characteristics:

- The CDB is named `newcdb`. Its global database name is `newcdb.us.example.com`, where the domain portion (`us.example.com`) is taken from the initialization parameter file. See *Oracle Database Administrator's Guide* for information about determining the global database name.
- The passwords for user accounts `SYS` and `SYSTEM` are set to the values that you specified. The passwords are case-sensitive. The two clauses that specify the passwords for `SYS` and `SYSTEM` are not mandatory in this release of Oracle Database. However, if you specify either clause, then you must specify both clauses. For further information about the use of these clauses, see *Oracle Database Administrator's Guide* for information about specifying passwords for users `SYS` and `SYSTEM`.
- The `DEFAULT TABLESPACE` clause creates and names a default permanent tablespace for this CDB.



- The `DEFAULT TEMPORARY TABLESPACE` clause creates and names a default temporary tablespace for the root of this CDB. See *Oracle Database Administrator's Guide* for information about creating a default temporary tablespace.
- The `UNDO TABLESPACE` clause creates and names an undo tablespace that is used to store undo data for this CDB. In a CDB, an undo tablespace is required to manage the undo data, and the `UNDO_MANAGEMENT` initialization parameter must be set to `AUTO`. If you omit this parameter, then it defaults to `AUTO`. See *Oracle Database Administrator's Guide* for information about creating an undo tablespace.
- Redo log files will not initially be archived, because the `ARCHIVELOG` clause is not specified in this `CREATE DATABASE` statement. This is customary during CDB creation. You can later use an `ALTER DATABASE` statement to switch to `ARCHIVELOG` mode. The initialization parameters in the initialization parameter file for `newcdb` relating to archiving are `LOG_ARCHIVE_DEST_1` and `LOG_ARCHIVE_FORMAT`. See *Oracle Database Administrator's Guide* for information about managing archived redo log files.
- The `ENABLE PLUGGABLE DATABASE` clause creates a CDB with the root and the PDB seed.
- `SEED` is required for the `tablespace_datafile` clauses.
- The `SYSTEM DATAFILES` clause specifies attributes of the PDB seed's `SYSTEM` tablespace data file(s) that differ from the root's.
- The `SYSAUX DATAFILES` clause specifies attributes of the PDB seed's `SYSAUX` tablespace data file(s) that differ from the root's.

## 4.4 Configuring EM Express for a CDB

For a CDB, you can configure Oracle Enterprise Manager Database Express (EM Express) for the root and for each PDB by setting a global HTTPS port, or you can set a different port for every container in the CDB.

You can set a global port, which enables you to use EM Express to connect to all PDBs in the CDB using the HTTP or HTTPS port for the CDB. Alternatively, you can set a different HTTP or HTTPS port for every container in a CDB.

### To configure EM Express for a CDB:

1. In SQL\*Plus, access a container in a CDB.  
The user must have common `SYSDBA` administrative privilege, and you must exercise this privilege using `AS SYSDBA` at connect time. The container can be the root or a PDB.  
See "[About Container Access in a CDB](#)".
2. Set the port in one of the following ways:
  - To set the global port, connect to the `CDB$ROOT`, and issue the following SQL statement to configure the global port for the CDB:

```
exec DBMS_XDB_CONFIG.SETGLOBALPORTENABLED(TRUE);
```



- To set the HTTP port for the current container, run the following procedure:

```
exec DBMS_XDB_CONFIG.SETHTTPPORT(http_port_number);
```

Replace *http\_port\_number* with the appropriate HTTP port number.

- To set the HTTPS port for the current container, run the following procedure:

```
exec DBMS_XDB_CONFIG.SETHTTPSPORT(https_port_number);
```

Replace *https\_port\_number* with the appropriate HTTPS port number.

### 3. Access EM Express in one of the following ways:

- To use the global port, enter the EM Express URL provided by Database Configuration Assistant (DBCA) when it configured the CDB that includes the PDB. When the EM Express login screen appears, specify your administrator credentials, and enter the name of the PDB that you want to connect to in the **Container Name** field.

- The URL for the HTTP port for a container:

```
http://database_hostname:http_port_number/em/
```

Replace *database\_hostname* with the host name of the computer on which the database instance is running, and replace *http\_port\_number* with the appropriate HTTP port number.

- The URL for the HTTPS port for a container:

```
https://database_hostname:https_port_number/em/
```

Replace *database\_hostname* with the host name of the computer on which the database instance is running, and replace *https\_port\_number* with the appropriate HTTPS port number.

When connected to the root, EM Express displays data and enables actions that apply to the entire CDB. When connected to a PDB, EM Express displays data and enables actions that apply to the PDB only.

#### Note:

If the listener is not configured on port 1521, then you must manually configure the port for EM Express. See *Oracle Database 2 Day DBA* for instructions.

#### See Also:

*Oracle Database 2 Day DBA* for more information about EM Express

## 4.5 After Creating a CDB

After creation, a CDB consists of the root and the PDB seed.

The root contains system-supplied metadata and common users that can administer the PDBs. The PDB seed is a template that you can use to create new PDBs. The following graphic shows a newly created CDB.

**Figure 4-1 A Newly Created CDB**

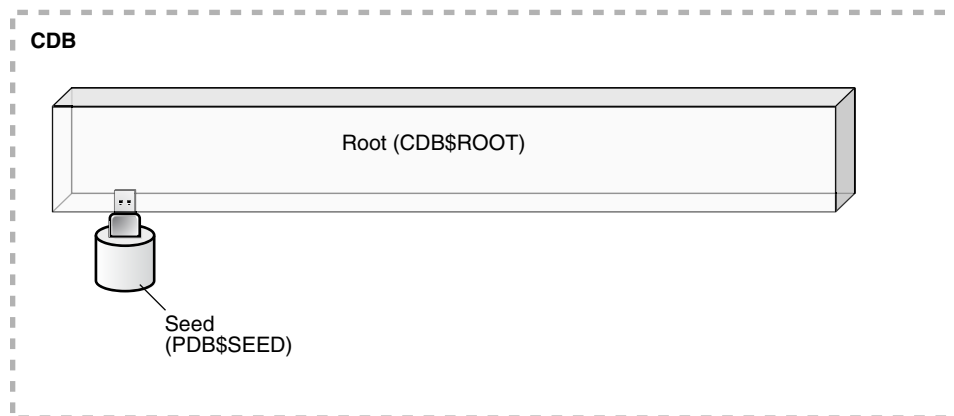

In a CDB, the root contains minimal user data or no user data. User data resides in the PDBs. Therefore, after creating a CDB, one of the first tasks is to add the PDBs that will contain the user data.

The following graphic shows a CDB with PDBs.

**Figure 4-2 CDB with PDBs**

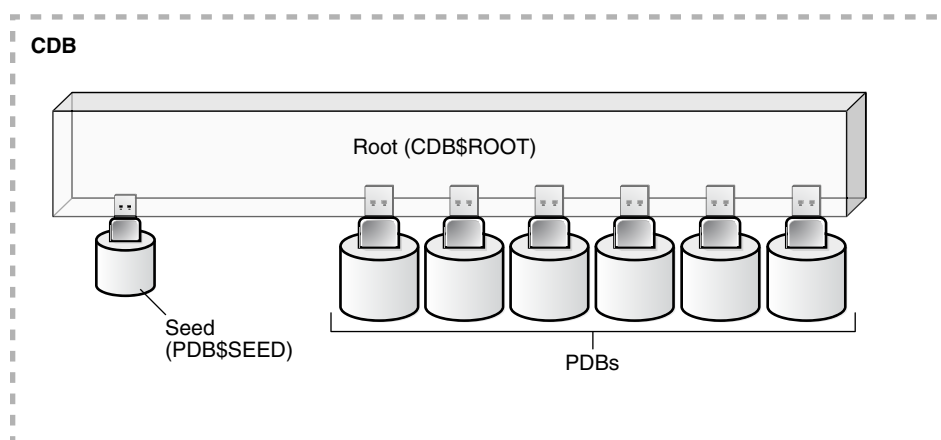

You have the option of creating one or more application containers. An application container consists of an application root and application PDBs, and it stores data for one or more applications. An application container can store application common objects, which contain user data that can be shared by the application PDBs in the

application container. It can also contain an application seed for fast creation of application PDBs in an application container.

**Figure 4-3 Application Containers in a CDB**

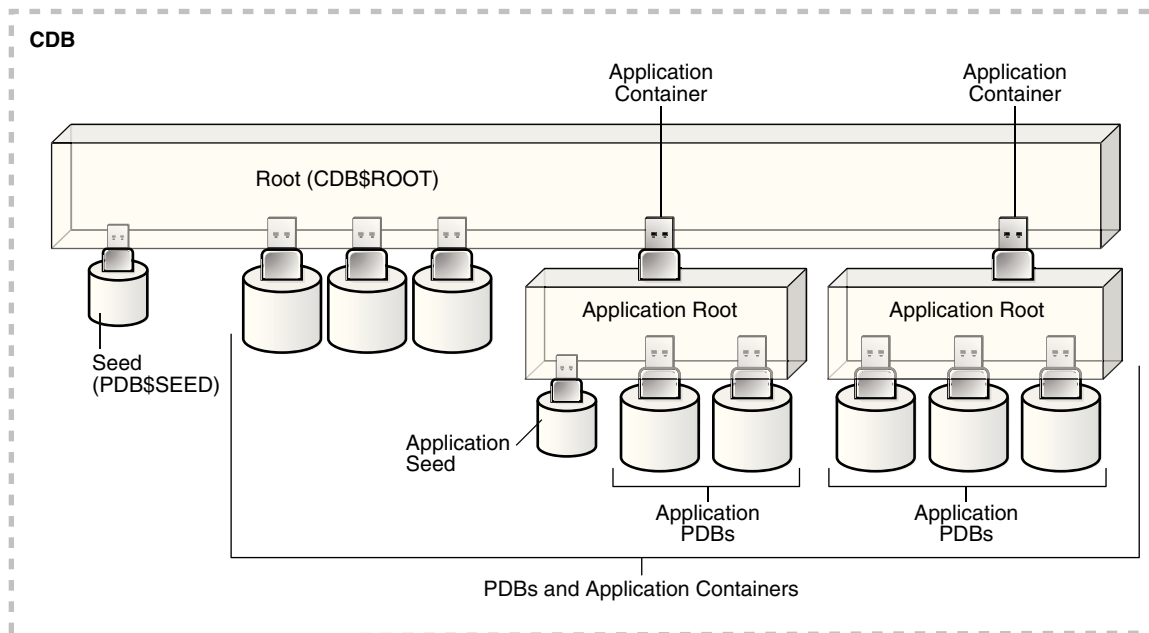

When you have added the PDBs and application containers to the CDB, the physical structure of a CDB is very similar to the physical structure of a non-CDB. A CDB contains the following files:

- One control file
- One active online redo log for a single-instance CDB, or one active online redo log for each instance of an Oracle RAC CDB
- Sets of temp files

There is one default temporary tablespace for the root of the CDB and one for each PDB, application root, and application PDB.

- Sets of system data files

The primary physical difference between a CDB and a non-CDB is in the data files. A non-CDB has only one set of system data files. In contrast, a CDB includes one set of system data files for each container in the CDB, including a set of system data files for each PDB, application root, and application PDB. In addition, a CDB has one set of user-created data files for each container. If the CDB is in local undo mode, then each container also has its own undo tablespace and associated data files.

- Sets of user-created data files

Each PDB has its own set of non-system data files. These data files contain the user-defined schemas and database objects for the PDB.

For backup and recovery of a CDB, Recovery Manager (RMAN) is recommended. PDB point-in-time recovery (PDB PITR) must be performed with RMAN. By default, RMAN turns on control file autobackup for a CDB. It is strongly recommended that

control file autobackup is enabled for a CDB, to ensure that PDB PITR can undo data file additions or deletions.

 [Video](#)

Because the physical structure of a CDB and a non-CDB are similar, most management tasks are the same for a CDB and a non-CDB. However, some administrative tasks are specific to CDBs. The following chapters describe these tasks:

- ["Creating and Removing PDBs and Application Containers"](#)

This chapter documents the following tasks:

- Creating a PDB using the PDB seed
- Creating a PDB by cloning an existing PDB or Non-CDB
- Creating a PDB by relocating it
- Creating a PDB as a proxy PDB
- Plugging in a PDB
- Unplugging a PDB
- Dropping a PDB

- ["Creating and Removing Application Containers and Seeds"](#)

This chapter documents the following tasks:

- Creating application containers
- Creating application seeds
- Unplugging application containers
- Unplugging application seeds
- Dropping application containers
- Dropping application seeds

- ["Administering a CDB"](#)

This chapter documents the following tasks:

- Connecting to a container
- Switching into a container
- Modifying a CDB
- Modifying the root
- Changing the open mode of a PDB
- Executing DDL statements in a CDB
- Shutting down the CDB instance

- ["Administering CDBs and PDBs with Cloud Control"](#)

This chapter documents the following tasks:

- Managing CDB storage and schema objects
- Managing per-container storage and schema objects
- Monitoring storage and schema alerts

- Switching into a container
- Changing the open mode of a PDB
- ["Administering PDBs"](#)

This chapter documents the following tasks:

  - Connecting to a PDB
  - Modifying a PDB
  - Managing services associated with PDBs
- ["Administering Application Containers"](#)

This chapter documents the following tasks:

  - Managing applications in an application container, including installing, upgrading, and patching applications
  - Managing application common objects
  - Issuing DML statements on containers in an application container
  - Partitioning by PDB with container maps
- ["Monitoring CDBs and PDBs"](#)

This chapter documents the following tasks:

  - Querying views for monitoring a CDB and its PDBs
  - Running sample queries that provide information about a CDB and its PDBs
- ["Using Oracle Resource Manager for PDBs"](#)

This chapter documents the following tasks:

  - Creating resource plans in a CDB
  - Managing resource plans in a CDB
- ["Using Oracle Scheduler with a CDB"](#)

This chapter documents the following topics:

  - DBMS\_SCHEDULER invocations in a CDB
  - Job coordinator and slave processes in a CDB
  - Using DBMS\_JOB
  - Processes to close a PDB
  - New and changed views



#### See Also:

- *Oracle Database Concepts* for a multitenant architecture documentation roadmap
- *Oracle Database Backup and Recovery User's Guide* for information about RMAN

# Part III

## Creating and Removing PDBs and Application Containers

You can create PDBs, application containers, and application seeds using a variety of techniques.

For example, you can create a PDB from scratch, cloning an existing PDB or non-CDB, or plug in an unplugged PDB. You can also remove PDBs from a CDB.

### Note:

You can complete the tasks in this part using SQL\*Plus or Oracle SQL Developer.

This part contains the following chapters:

- [Overview of PDB Creation](#)  
A CDB supports multiple techniques for creating PDBs.
- [Creating a PDB from Scratch](#)  
Use the `CREATE PLUGGABLE DATABASE` statement to create a PDB in a CDB using the files of the PDB seed (`PDB$SEED`).
- [Cloning a PDB or Non-CDB](#)  
You can create a PDB by cloning a local PDB, a remote PDB, or a non-CDB.
- [Relocating a PDB](#)  
You can move a PDB to a different CDB or application container.
- [Plugging In an Unplugged PDB](#)  
You can create a PDB by plugging an unplugged PDB into a CDB.
- [Creating a PDB as a Proxy PDB](#)  
You can create a PDB as a proxy PDB by referencing it in a remote CDB.
- [Removing a PDB](#)  
You can remove a plugged-in PDB from a CDB by unplugging it, dropping it, or relocating it.
- [Creating and Removing Application Containers and Seeds](#)  
You can create application containers and application seeds in several different ways. You can also remove application containers from a CDB, and you can remove application seeds from application containers.

### Related Topics

- [Tools for a Multitenant Environment](#)  
You can use various tools to configure and administer a multitenant environment.

# 5

## Overview of PDB Creation

A CDB supports multiple techniques for creating PDBs.

The created PDB automatically includes a full data dictionary including metadata and internal links to system-supplied objects in the CDB root. You must define every PDB from a single root: either the [CDB root](#) or an [application root](#).

Each PDB has a globally unique identifier (GUID). The PDB GUID is primarily used to generate names for directories that store the PDB's files, including both Oracle Managed Files directories and non-Oracle Managed Files directories.

This chapter contains the following topics:

- [Techniques for Creating a PDB](#)  
You can create a PDB with various techniques, all of which require the `CREATE PLUGGABLE DATABASE` statement.
- [PDB Storage](#)  
However you choose to create a PDB, you must decide on the tablespaces and files that will store the data.
- [Service Name Conversion](#)  
An important aspect of PDB creation is managing the renaming of database services.
- [Summary of Clauses for Creating a PDB](#)  
When you create a PDB with the `CREATE PLUGGABLE DATABASE` statement, various clauses are available based on different factors.
- [General Prerequisites for PDB Creation](#)  
Before creating a PDB, you must meet certain prerequisites.

### 5.1 Techniques for Creating a PDB

You can create a PDB with various techniques, all of which require the `CREATE PLUGGABLE DATABASE` statement.

Creating a PDB is the process of associating it with a CDB or an application container.

The following graphic depicts the options for creating a PDB.

**Figure 5-1 Options for Creating a PDB**

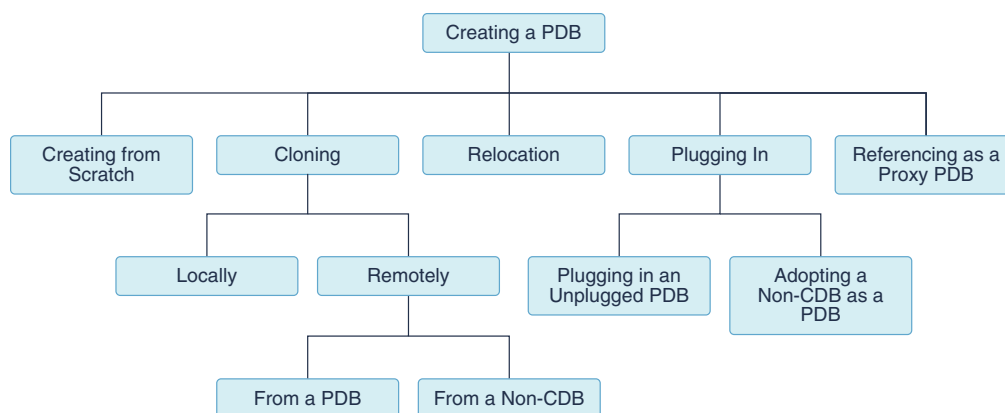

The following table describes the creation techniques. An additional technique, which is not covered in this manual, is to use the `Duplicate` command in Recovery Manager to copy a PDB from one CDB to another CDB.

**Table 5-1 Techniques for Creating a PDB**

Technique	Description	More Information
Create a PDB from scratch	Create a PDB in a CDB using the files of the PDB seed or application seed. This technique copies the files associated with the seed to a new location and associates the copied files with the new PDB. This is the default creation mechanism. The other techniques require either a source database (PDB or non-CDB) or XML.	<a href="#">"Creating a PDB from Scratch"</a>
Clone an existing PDB or non-CDB	Create a PDB by cloning a source PDB or non-CDB. A source can be a PDB in the local CDB, a PDB in a remote CDB, a PDB in a local or remote application container, or a non-CDB. This technique copies the files associated with the source to a new location and associates the copied files with the new PDB.	<a href="#">"Cloning a PDB or Non-CDB"</a>
Relocate a PDB to a different CDB	Create a PDB by relocating it from one CDB to another. This technique moves the files associated with the PDB to a new location.	<a href="#">"Relocating a PDB"</a>
Plug an unplugged PDB into a CDB	Create a PDB by using the XML metadata file that describes the PDB and the files associated with the PDB to plug it into the CDB.	<a href="#">"Plugging In an Unplugged PDB"</a>
Reference a PDB as a proxy PDB	Create a PDB as a proxy PDB by referencing a different PDB with a database link. The referenced PDB can be in the same CDB as the proxy PDB, or it can be in a different CDB.	<a href="#">"Creating a PDB as a Proxy PDB"</a>



Table 5-1 (Cont.) Techniques for Creating a PDB

Technique	Description	More Information
Create a PDB from a non-CDB, and then plug the PDB into a CDB	Create a PDB by adopting a non-CDB into a PDB. You can use the <code>DBMS_PDB</code> package to create an unplugged PDB from an Oracle Database 12c non-CDB. You can then plug the unplugged PDB into the CDB.	<a href="#">"Options for Creating a PDB from a Non-CDB"</a>

You can unplug a PDB when you want to plug it into a different CDB. You can unplug or drop a PDB when you no longer need it. An unplugged PDB is not usable until it is plugged into a CDB.

This section contains the following topics:

- [Current Container and PDB Creation](#)  
You can use the `CREATE PLUGGABLE DATABASE` statement to create PDBs, application containers, application seeds, and application PDBs.
- [Options for Creating a PDB from a Non-CDB](#)  
You have multiple options for moving a non-CDB into a PDB.

#### See Also:

- ["Creating and Removing Application Containers"](#)
- ["Unplugging a PDB from a CDB"](#)
- ["Dropping a PDB"](#)
- *Oracle Database Backup and Recovery User's Guide* to learn how to copy a PDB using the `DUPLICATE` command
- *Oracle Database SQL Language Reference* for more information about the `CREATE PLUGGABLE DATABASE` statement

## 5.1.1 Current Container and PDB Creation

You can use the `CREATE PLUGGABLE DATABASE` statement to create PDBs, application containers, application seeds, and application PDBs.

When you create a PDB, the current container—CDB root or application root—determines the association of the PDB. The SQL statements that create PDBs and application PDBs are the same. For example, when you run `CREATE PLUGGABLE DATABASE` statement in the CDB root, the PDB belongs to the CDB root. When you run `CREATE PLUGGABLE DATABASE` statement in an application root, the application PDB belongs to the application root.

When the CDB root is the current container, create an application root by running a `CREATE PLUGGABLE DATABASE` statement with the `AS APPLICATION CONTAINER` clause. When cloning, relocating, or plugging in a PDB to an application container, the application name and version of the PDB must match the application name and version of the application container.

## 5.1.2 Options for Creating a PDB from a Non-CDB

You have multiple options for moving a non-CDB into a PDB.

You can accomplish this task in the following ways:

- Clone a non-CDB

This is the simplest way to create a PDB using a non-CDB, but it requires copying the files of the non-CDB to a new location.

Both the CDB and the non-CDB must be running Oracle Database 12c Release 1 (12.1.0.2) or later. If your current non-CDB uses an Oracle Database release before Oracle Database 12c Release 1 (12.1.0.2), then you must upgrade the non-CDB to a later release to use this technique.

- Generate an XML metadata file by using the `DBMS_PDB` package

The XML metadata file describes the database files of the non-CDB so that you can plug it into a CDB.

This method requires more steps than creating a PDB by cloning a non-CDB, but it enables you to create a PDB using a non-CDB without moving the non-CDB files in some situations.

To use this technique, the non-CDB must run Oracle Database 12c or later. If your current non-CDB uses a release before Oracle Database 12c, then you must upgrade to a later release.

- Export the data from the non-CDB and import it into a PDB using Oracle Data Pump

When you import, specify the connect identifier for the PDB after the user name. For example, if the connect identifier for the PDB is `hrpdb`, then enter the following when you run the Oracle Data Pump Import utility:

```
impdp user_name@hrpdb ...
```

If the Oracle Database release of the non-CDB is Oracle Database 11g Release 2 (11.2.0.3) or later, then you can use full transportable export/import to move the data. When transporting a non-CDB from an Oracle Database 11g Release 2 (11.2.0.3) or later Oracle Database 11g database to Oracle Database 12c or later, the `VERSION` Data Pump export parameter must be set to `12.0.0.0.0` or higher.

If the Oracle Database release of the non-CDB is before Oracle Database 11g Release 2 (11.2.0.3), then you can use transportable tablespaces to move the data, or you can perform a full database export/import.

- Replicate data from the non-CDB to a PDB using GoldenGate

When the PDB catches up with the non-CDB, you fail over to the PDB.

See the Oracle GoldenGate documentation.

 **See Also:**

- ["Cloning a PDB or Non-CDB"](#)
- ["Adopting a Non-CDB as a PDB"](#)
- *Oracle Database Upgrade Guide* for information about upgrading
- *Oracle Database Administrator's Guide* for information about transporting data

## 5.2 PDB Storage

However you choose to create a PDB, you must decide on the tablespaces and files that will store the data.

This section contains the following topics:

- [Storage Limits](#)  
The optional `STORAGE` clause of the `CREATE PLUGGABLE DATABASE` statement specifies storage limits for PDBs.
- [Default Tablespace](#)  
The `DEFAULT TABLESPACE` clause of the `CREATE PLUGGABLE DATABASE` statement specifies the default tablespace for the new PDB.
- [User Tablespaces](#)  
The `USER_TABLESPACES` clause of the `CREATE PLUGGABLE DATABASE` statement specifies which tablespaces are available in the new PDB.
- [PDB File Locations](#)  
In the `CREATE PLUGGABLE DATABASE` statement, you can specify the locations of files used by the new PDB.

### 5.2.1 Storage Limits

The optional `STORAGE` clause of the `CREATE PLUGGABLE DATABASE` statement specifies storage limits for PDBs.

The `STORAGE` clause specifies the following limits:

- The amount of storage that can be used by all tablespaces that belong to the PDB  
Use `MAXSIZE` and a size clause to specify a limit, or set `MAXSIZE` to `UNLIMITED` to indicate no limit.
- The amount of storage that can be used by unified audit OS spillover (.bin format) files in the PDB  
Use `MAX_AUDIT_SIZE` and a size clause to specify a limit, or set `MAX_AUDIT_SIZE` to `UNLIMITED` to indicate no limit.
- The amount of diagnostics (trace files and incident dumps) in the Automatic Diagnostic Repository (ADR) that can be used by the PDB  
Use `MAX_DIAG_SIZE` and a size clause to specify a limit, or set `MAX_DIAG_SIZE` to `UNLIMITED` to indicate no limit.

If `STORAGE UNLIMITED` is set, or if there is no `STORAGE` clause, then there are no storage limits for the PDB.

The following are examples that use the `STORAGE` clause.

#### Example 5-1 STORAGE Clause That Specifies a Storage Limit

This `STORAGE` clause specifies that the storage used by all tablespaces that belong to the PDB must not exceed 2 gigabytes.

```
STORAGE (MAXSIZE 2G)
```

#### Example 5-2 STORAGE Clause That Specifies Unlimited Storage

This `STORAGE` clause specifies unlimited storage for all tablespaces that belong to the PDB.

```
STORAGE (MAXSIZE UNLIMITED)
```



#### See Also:

*Oracle Database SQL Language Reference* for the syntax of the `STORAGE` clause

## 5.2.2 Default Tablespace

The `DEFAULT TABLESPACE` clause of the `CREATE PLUGGABLE DATABASE` statement specifies the default tablespace for the new PDB.

Oracle Database will assign the default tablespace to any non-`SYSTEM` users who do not have a different permanent tablespace specified.

When you create the PDB from the PDB seed or an application seed and specify the `DEFAULT TABLESPACE` clause, Oracle Database creates a smallfile tablespace and sets it as the default tablespace for the PDB. When you create the PDB using a method other than the using the PDB seed or application seed, such as cloning a PDB or plugging in an unplugged PDB, the default tablespace must be a tablespace that already exists in the source PDB.

#### Example 5-3 DEFAULT TABLESPACE Clause

```
DEFAULT TABLESPACE sales
```

## 5.2.3 User Tablespaces

The `USER_TABLESPACES` clause of the `CREATE PLUGGABLE DATABASE` statement specifies which tablespaces are available in the new PDB.

You can use this clause to separate the data for multiple schemas into different PDBs. For example, when you move a non-CDB to a PDB, and the non-CDB had several schemas that each supported a different application, you can use this clause to

separate the data belonging to each schema into a separate PDB. This technique assumes that each schema used a separate tablespace in the non-CDB.

You can use this clause to specify one of the following options:

- List one or more tablespaces to include.
- Specify `ALL`, the default, to include all tablespaces.
- Specify `ALL EXCEPT` to include all tablespaces, except for the tablespaces listed.
- Specify `NONE` to exclude all tablespaces.
- If the creation mode of the user tablespaces must be different from the creation mode for the Oracle-supplied tablespaces (such as `SYSTEM` and `SYSAUX`), then specify one of the following in the `USER_TABLESPACES` clause:
  - `COPY`: The files of the tablespaces are copied to a new location.
  - `MOVE`: The files of the tablespaces are moved to a new location.
  - `NOCOPY`: The files of the tablespaces are not copied or moved.
  - `SNAPSHOT COPY`: The tablespaces are cloned with storage snapshots.
  - `NO DATA`: The data model definition of the tablespaces is cloned but not the tablespaces' data.

When the compatibility level of the CDB is 12.2.0 or higher, the tablespaces that are excluded by this clause are created offline in the new PDB, and they have no data files associated with them. When the compatibility level of the CDB is lower than 12.2.0, the tablespaces that are excluded by this clause are offline in the new PDB, and all data files that belong to these tablespaces are unnamed and offline.

This clause does not apply to the `SYSTEM`, `SYSAUX`, or `TEMP` tablespaces. Do not include these tablespaces in a tablespace list for this clause.

The following are examples that use the `USER_TABLESPACES` clause.

#### **Example 5-4 USER\_TABLESPACES Clause That Includes One Tablespace**

Assume that the non-CDB or PDB from which a PDB is being created includes the following tablespaces: `tbs1`, `tbs2`, and `tbs3`. This `USER_TABLESPACES` clause includes the `tbs2` tablespace, but excludes the `tbs1` and `tbs3` tablespaces.

```
USER_TABLESPACES=('tbs2')
```

#### **Example 5-5 USER\_TABLESPACES Clause That Includes a List of Tablespaces**

Assume that the non-CDB or PDB from which a PDB is being created includes the following tablespaces: `tbs1`, `tbs2`, `tbs3`, `tbs4`, and `tbs5`. This `USER_TABLESPACES` clause includes the `tbs1`, `tbs4`, and `tbs5` tablespaces, but excludes the `tbs2` and `tbs3` tablespaces.

```
USER_TABLESPACES=('tbs1','tbs4','tbs5')
```

### Example 5-6 USER\_TABLESPACES Clause That Includes All Tablespaces Except for Listed Ones

Assume that the non-CDB or PDB from which a PDB is being created includes the following tablespaces: `tbs1`, `tbs2`, `tbs3`, `tbs4`, and `tbs5`. This `USER_TABLESPACES` clause includes the `tbs2` and `tbs3` tablespaces, but excludes the `tbs1`, `tbs4`, and `tbs5` tablespaces.

```
USER_TABLESPACES=ALL EXCEPT('tbs1','tbs4','tbs5')
```

### Example 5-7 USER\_TABLESPACES in a Different Creation Mode

This example shows a full `CREATE PLUGGABLE DATABASE` statement that plugs in a non-CDB and only includes the `tbs3` user tablespace from the non-CDB. The example copies the files for Oracle-supplied tablespaces (such as `SYSTEM` and `SYSAUX`) to a new location, but moves the files of the `tbs3` user tablespace.

```
CREATE PLUGGABLE DATABASE ncdb USING '/disk1/oracle/ncdb.xml'  
  COPY  
  FILE_NAME_CONVERT = ('/disk1/oracle/dbs/', '/disk2/oracle/ncdb/')  
  USER_TABLESPACES=('tbs3') MOVE;
```

## 5.2.4 PDB File Locations

In the `CREATE PLUGGABLE DATABASE` statement, you can specify the locations of files used by the new PDB.

The term "file name" means both the name and the location of a file. The `CREATE PLUGGABLE DATABASE` statement has the following clauses that indicate the file names of the new PDB being created:

- The `FILE_NAME_CONVERT` clause specifies the names of the PDB's files after the PDB is created.

Use this clause when the files are not yet at their ultimate destination, and you want to copy or move them during PDB creation. You can use this clause in any `CREATE PLUGGABLE DATABASE` statement.

- The `CREATE_FILE_DEST` clause specifies the default Oracle Managed Files file system directory or Oracle ASM disk group for the PDB's files.

Use this clause to enable Oracle Managed Files for the new PDB, independent of any Oracle Managed Files default location specified in the root for the CDB. You can use this clause in any `CREATE PLUGGABLE DATABASE` statement.

When necessary, you can use both clauses in the same `CREATE PLUGGABLE DATABASE` statement. In addition, the following initialization parameters can control the location of the new PDB files:

- The `DB_CREATE_FILE_DEST` initialization parameter set in the root

This initialization parameter specifies the default location for Oracle Managed Files for the CDB. When this parameter is set in a PDB, it specifies the default location for Oracle Managed Files for the PDB.

- The `PDB_FILE_NAME_CONVERT` initialization parameter

This initialization parameter maps names of existing files to new file names when processing a `CREATE PLUGGABLE DATABASE` statement.

The following table shows the precedence order when both clauses are used in the same `CREATE PLUGGABLE DATABASE` statement, and both initialization parameters are set. For each clause and initialization parameter, the table also shows whether the files created by the `CREATE PLUGGABLE DATABASE` statement will use Oracle Managed Files or not.

**Table 5-2 Summary of File Location Clauses and Initialization Parameters**

Clause or Initialization Parameter	Precedence Order	Will the Files Created by <code>CREATE PLUGGABLE DATABASE</code> Use Oracle Managed Files?
<code>FILE_NAME_CONVERT</code> clause	1	No
<code>CREATE_FILE_DEST</code> clause	2	Yes
<code>DB_CREATE_FILE_DEST</code> initialization parameter	3	Yes
<code>PDB_FILE_NAME_CONVERT</code> initialization parameter	4	No

Regarding the use of Oracle Managed Files, the table only applies to files created by the `CREATE PLUGGABLE DATABASE` statement. Files created for the PDB after the PDB has been created might or might not use Oracle Managed Files.

In addition, if `FILE_NAME_CONVERT` and `CREATE_FILE_DEST` are both specified in the `CREATE PLUGGABLE DATABASE` statement, then the `FILE_NAME_CONVERT` setting is used for the files being placed during PDB creation, and the `CREATE_FILE_DEST` setting is used to set the `DB_CREATE_FILE_DEST` initialization parameter in the PDB. In this case, Oracle Managed Files controls the location of the files for the PDB after PDB creation.

 **Note:**

The `PATH_PREFIX` clause does not affect files created by Oracle Managed Files.

This section contains the following topics:

- [FILE\\_NAME\\_CONVERT Clause](#)  
If the PDB will not use Oracle Managed Files, then the `FILE_NAME_CONVERT` clause of the `CREATE PLUGGABLE DATABASE` statement specifies how to generate the names of files (such as data files) using the names of existing files.
- [CREATE\\_FILE\\_DEST Clause](#)  
The `CREATE_FILE_DEST` clause of the `CREATE PLUGGABLE DATABASE` statement enables Oracle Managed Files for the PDB and specifies the default file system directory or Oracle ASM disk group for the PDB files.
- [Restrictions on PDB File Locations](#)  
The `PATH_PREFIX` clause of the `CREATE PLUGGABLE DATABASE` statement ensures that all directory object paths associated with the PDB are restricted to the specified directory or its subdirectories.

 **See Also:**

Oracle Database Reference to learn more about `DB_CREATE_FILE_DEST` and `PDB_FILE_NAME_CONVERT`

### 5.2.4.1 FILE\_NAME\_CONVERT Clause

If the PDB will not use Oracle Managed Files, then the `FILE_NAME_CONVERT` clause of the `CREATE PLUGGABLE DATABASE` statement specifies how to generate the names of files (such as data files) using the names of existing files.

You can use this clause to specify one of the following options:

- One or more file name patterns and replacement file name patterns, in the following form:

```
'string1' , 'string2' , 'string3' , 'string4' , ...
```

The *string2* file name pattern replaces the *string1* file name pattern, and the *string4* file name pattern replaces the *string3* file name pattern. You can use as many pairs of file name pattern and replacement file name pattern strings as required.

If you specify an odd number of strings (the last string has no corresponding replacement string), then an error is returned. Do not specify more than one pattern/replace string that matches a single file name or directory.

- `NONE` when no files should be copied or moved during PDB creation. Omitting the `FILE_NAME_CONVERT` clause is the same as specifying `NONE`.

You can use the `FILE_NAME_CONVERT` clause in any `CREATE PLUGGABLE DATABASE` statement.

When the `FILE_NAME_CONVERT` clause is not specified in a `CREATE PLUGGABLE DATABASE` statement, either Oracle Managed Files or the `PDB_FILE_NAME_CONVERT` initialization parameter specifies how to generate the names of the files. If you use both Oracle Managed Files and the `PDB_FILE_NAME_CONVERT` initialization parameter, then Oracle Managed Files takes precedence. The `FILE_NAME_CONVERT` clause takes precedence when it is specified.

File name patterns specified in the `FILE_NAME_CONVERT` clause cannot match files or directories managed by Oracle Managed Files.

#### Example 5-8 FILE\_NAME\_CONVERT Clause

This `FILE_NAME_CONVERT` clause generates file names for the new PDB in the `/oracle/pdb5` directory using file names in the `/oracle/dbs` directory.

```
FILE_NAME_CONVERT = ('/oracle/dbs/', '/oracle/pdb5/')
```



 **See Also:**

- ["Example 19-7"](#)
- *Oracle Database Administrator's Guide*
- *Oracle Database SQL Language Reference* for the syntax of the `FILE_NAME_CONVERT` clause
- *Oracle Database Reference* for information about the `PDB_FILE_NAME_CONVERT` initialization parameter

## 5.2.4.2 CREATE\_FILE\_DEST Clause

The `CREATE_FILE_DEST` clause of the `CREATE PLUGGABLE DATABASE` statement enables Oracle Managed Files for the PDB and specifies the default file system directory or Oracle ASM disk group for the PDB files.

The PDB data files and temp files are restricted to the specified directory and its subdirectories. If a file system directory is specified as the default location in this clause, then the directory must exist. Also, the user who runs the `CREATE PLUGGABLE DATABASE` statement must have the appropriate privileges to create files in the specified directory. Alternatively, you can specify the name of a directory object that exists in the CDB root (`CDB$ROOT`). The directory object points to the file system directory used by `CREATE_FILE_DEST`.

If there is a default Oracle Managed Files location for the CDB set in the CDB root, then the `CREATE_FILE_DEST` setting overrides the CDB root's setting, and the specified `CREATE_FILE_DEST` setting is used for the PDB.

If `CREATE_FILE_DEST=NONE` is specified, then Oracle Managed Files is disabled for the PDB.

When the `CREATE_FILE_DEST` clause is set to a value other than `NONE`, the `DB_CREATE_FILE_DEST` initialization parameter is set implicitly in the PDB with `SCOPE=SPFILE`.

If the CDB root uses Oracle Managed Files, and this clause is not specified, then the PDB inherits the Oracle Managed Files default location from the CDB root.

 **Note:**

This feature is available starting with Oracle Database 12c Release 1 (12.1.0.2).

### Example 5-9 CREATE\_FILE\_DEST Clause

This `CREATE_FILE_DEST` clause specifies `/oracle/pdb2/` as the default Oracle Managed Files file system directory for the new PDB.

```
CREATE_FILE_DEST = '/oracle/pdb2/'
```

**See Also:**

*Oracle Database Administrator's Guide*

### 5.2.4.3 Restrictions on PDB File Locations

The `PATH_PREFIX` clause of the `CREATE PLUGGABLE DATABASE` statement ensures that all directory object paths associated with the PDB are restricted to the specified directory or its subdirectories.

This clause also ensures that the following files associated with the PDB are restricted to the specified directory: the Oracle XML repository for the PDB, files created with a `CREATE PFILE` statement, and the export directory for Oracle wallets. Use this clause when you want to ensure that a PDB's files reside in a specific directory and its subdirectories.

You can use this clause to specify one of the following options:

- An absolute path that is used as a prefix for all file paths associated with the PDB.
- The name of a directory object that exists in the CDB root (`CDB$ROOT`). The directory object points to the absolute path to be used for `PATH_PREFIX`.
- `NONE` to indicate that there are no restrictions for the file paths. Omitting the `PATH_PREFIX` clause is the same as specifying `NONE`.

After a PDB is created, its `PATH_PREFIX` setting cannot be modified.

You can use the `PATH_PREFIX` clause in any `CREATE PLUGGABLE DATABASE` statement.

#### **Example 5-10** `PATH_PREFIX` Clause

This `PATH_PREFIX` clause ensures that all file paths associated with the PDB are restricted to the `/disk1/oracle/dbs/salespdb/` directory.

```
PATH_PREFIX = '/disk1/oracle/dbs/salespdb/'
```

Be sure to specify the path name so that it is properly formed when file names are appended to it. For example, on UNIX systems, be sure to end the path name with a forward slash (`/`).

 **Note:**

- After the `PATH_PREFIX` clause is specified for a PDB, existing directory objects might not work as expected, since the `PATH_PREFIX` string is always added as a prefix to all local directory objects in the PDB.
- The `PATH_PREFIX` clause does not affect files created by Oracle Managed Files.
- The `PATH_PREFIX` clause only applies to user-created directory objects. It does not apply to Oracle-supplied directory objects.
- The `PATH_PREFIX` clause does not apply to data files or temporary files. If you are using Oracle Managed Files, then use the `CREATE_FILE_DEST` clause to restrict the locations of data files and temporary files.

 **See Also:**

- ["About a Multitenant Environment"](#)
- ["Viewing Information About the Containers in a CDB"](#)

## 5.3 Service Name Conversion

An important aspect of PDB creation is managing the renaming of database services.

When the service name of a new PDB conflicts with an existing service name in the CDB, plug-in violations can result. The `SERVICE_NAME_CONVERT` clause of the `CREATE PLUGGABLE DATABASE` statement renames the user-defined services of the new PDB based on the service names of the source PDB. Using this clause, you can rename services and avoid plug-in violations.

You can use this clause to specify one of the following options:

- One or more service names and replacement service names, in the following form:

```
'string1' , 'string2' , 'string3' , 'string4' , ...
```

The *string2* service name replaces the *string1* service name, and the *string4* service name replaces the *string3* service name. You can use as many pairs of service names and replacement service names as required.

If you specify an odd number of strings (the last string has no corresponding replacement string), then an error is returned.

- `NONE` when no service names need to be renamed. Omitting the `SERVICE_NAME_CONVERT` clause is the same as specifying `NONE`.

You can use the `SERVICE_NAME_CONVERT` clause in any `CREATE PLUGGABLE DATABASE` statement, except for a `CREATE PLUGGABLE DATABASE` statement that creates a PDB from the PDB seed. The PDB seed cannot have user-defined services. However, you

can use this statement for a `CREATE PLUGGABLE DATABASE` statement that creates an application PDB from an application seed in an application container.



**Note:**

This clause does not apply to the default service for the PDB. The default service has the same name as the PDB.

**Example 5-11 SERVICE\_NAME\_CONVERT Clause**

This `SERVICE_NAME_CONVERT` clause uses renames the `salesrep` service to `salesperson`.

```
SERVICE_NAME_CONVERT = ('salesrep','salesperson')
```



**See Also:**

*Oracle Database SQL Language Reference*

## 5.4 Summary of Clauses for Creating a PDB

When you create a PDB with the `CREATE PLUGGABLE DATABASE` statement, various clauses are available based on different factors.

One factor is the technique you are using to create the PDB. You can determine which clauses to use by answering a series of questions.

The following table describes which `CREATE PLUGGABLE DATABASE` clauses to specify based on different factors.

**Table 5-3 Clauses for Creating a PDB**

Question	Yes	No	Clause Can Be Used Only When
Do you want to create an application container instead of a PDB?	Specify the <code>AS APPLICATION CONTAINER</code> clause.	Omit the <code>AS APPLICATION CONTAINER</code> clause.	Creating an application container in a CDB
Are you plugging a PDB into a CDB that contains one or more PDBs that were created by plugging in the same PDB?	Specify the <code>AS CLONE</code> clause to ensure that Oracle Database generates a unique PDB DBID, GUID, and other identifiers expected for the new PDB. The PDB is plugged in as a clone of the unplugged PDB to ensure that all of its identifiers are unique.	Omit the <code>AS CLONE</code> clause.	Plugging in an unplugged PDB

**Table 5-3 (Cont.) Clauses for Creating a PDB**

Question	Yes	No	Clause Can Be Used Only When
Do you want to create an application seed in an application container?	Specify the <code>AS SEED</code> clause.	Omit the <code>AS SEED</code> clause.	Creating an application seed in an application container
Do you want to use a <code>CREATE_FILE_DEST</code> clause to specify the Oracle Managed Files default location for the PDB files?  When creating a PDB from the PDB seed or an application seed, the source files are the files associated with the seed.	Include a <code>CREATE_FILE_DEST</code> clause that specifies the default file system directory or Oracle ASM disk group for the PDB's files.	Omit the <code>CREATE_FILE_DEST</code> clause. Use one of these techniques to specify the target locations of the files: <ul style="list-style-type: none"> <li>• <code>FILE_NAME_CONVERT</code> clause</li> <li>• Enable Oracle Managed Files for the CDB for it to determine the target locations.</li> <li>• Specify the target locations in the <code>PDB_FILE_NAME_CONVERT</code> initialization parameter.</li> </ul> See " <a href="#">PDB File Locations</a> ".	Creating a PDB from the PDB seed or an application seed  Cloning a PDB  Relocating a PDB  Plugging in an unplugged PDB
Do you want to specify a default permanent tablespace for the PDB?	Specify a <code>DEFAULT TABLESPACE</code> clause with the appropriate limits.  Oracle Database will assign to this tablespace any non- <code>SYSTEM</code> users for whom you do not specify a different permanent tablespace.  When creating a PDB from the PDB seed or an application seed, Oracle Database creates a <code>smallfile</code> tablespace and sets it as the default tablespace. When using a technique other than creation from the PDB seed or an application seed, the specified tablespace must exist in the source PDB.	Omit the <code>DEFAULT TABLESPACE</code> clause.  If you do not specify this clause, then the <code>SYSTEM</code> tablespace is the default permanent tablespace for non- <code>SYSTEM</code> users. Using the <code>SYSTEM</code> tablespace for non- <code>SYSTEM</code> users is not recommended.	Creating a PDB from the PDB seed or an application seed  Cloning a PDB  Relocating a PDB  Plugging in an unplugged PDB

**Table 5-3 (Cont.) Clauses for Creating a PDB**

Question	Yes	No	Clause Can Be Used Only When
<p>Do you want to use a <code>FILE_NAME_CONVERT</code> clause to specify the target locations of the files?</p> <p>When creating a PDB from the PDB seed or an application seed, the source files are the files associated with the seed.</p>	<p>Include a <code>FILE_NAME_CONVERT</code> clause that specifies the target locations of the files based on the names of the source files.</p>	<p>Omit the <code>FILE_NAME_CONVERT</code> clause.</p> <p>Use one of these techniques to specify the target locations of the files:</p> <ul style="list-style-type: none"> <li>• <code>CREATE_FILE_DEST</code> clause</li> <li>• Enable Oracle Managed Files for the CDB for it to determine the target locations.</li> <li>• Specify the target locations in the <code>PDB_FILE_NAME_CONVERT</code> initialization parameter.</li> </ul> <p>See "<a href="#">PDB File Locations</a>".</p>	<p>Creating a PDB from the PDB seed or an application seed</p> <p>Cloning a PDB</p> <p>Relocating a PDB</p> <p>Creating a proxy PDB (Only applies to data files in the <code>SYSTEM</code> and <code>SYSAUX</code> tablespaces.)</p> <p>Plugging in an unplugged PDB</p>
<p>Is the PDB a reference PDB with a dependent proxy PDB, and is the host name of its listener changing?</p>	<p>Include a <code>HOST</code> clause and specify the host name of the listener for the PDB being created.</p> <p>For example, you might have a listener network for the physical host name and default port and configure a second listener bound to a virtual host name and virtual IP address with a nondefault port number.</p>	<p>Omit the <code>HOST</code> clause.</p>	<p>Creating a PDB from the PDB seed or an application seed</p> <p>Cloning a PDB</p> <p>Relocating a PDB</p> <p>Plugging in an unplugged PDB</p>
<p>Do you want to specify the logging attribute of the tablespaces in the new PDB?</p>	<p>Include the <i>logging_clause</i>.</p>	<p>Omit the <i>logging_clause</i>.</p>	<p>Creating a PDB from the PDB seed or an application seed</p> <p>Cloning a PDB</p> <p>Plugging in an unplugged PDB</p>

**Table 5-3 (Cont.) Clauses for Creating a PDB**

Question	Yes	No	Clause Can Be Used Only When
Do you want to copy or move the files to a new location?	<p>Specify <code>COPY</code> to copy the files to a new location. <code>COPY</code> is the default. Specify <code>MOVE</code> to move the files to a new location. Use one of these techniques to specify the target location:</p> <ul style="list-style-type: none"> <li>• Include a <code>FILE_NAME_CONVERT</code> clause that specifies the target locations based on the names of the source files.</li> <li>• Include a <code>CREATE_FILE_DEST</code> clause that specifies the Oracle Managed Files default location for the PDB's files.</li> <li>• Enable Oracle Managed Files for it to determine the target locations.</li> <li>• Specify the target locations in the <code>PDB_FILE_NAME_CONVERT</code> initialization parameter.</li> </ul> <p>See "<a href="#">PDB File Locations</a>".</p>	Specify <code>NOCOPY</code> .	Plugging in an unplugged PDB
Do you want to specify that the data model definition of the source PDB is cloned but not the data of the source PDB?	Include the <code>NO DATA</code> clause.	Omit the <code>NO DATA</code> clause.	Cloning a PDB
Do you want to use multiple parallel execution servers to parallelize PDB creation?	<p>To let the CDB choose the degree of parallelism, include or omit the <code>PARALLEL</code> clause.</p> <p>To specify the degree of parallelism, specify the <code>PARALLEL</code> clause with an integer. For example, specify <code>PARALLEL 4</code> to indicate a degree of parallelism of 4.</p>	Specify <code>PARALLEL 0</code> or <code>PARALLEL 1</code> .	<p>Creating a PDB from the PDB seed or an application seed</p> <p>Cloning a PDB</p>

**Table 5-3 (Cont.) Clauses for Creating a PDB**

Question	Yes	No	Clause Can Be Used Only When
<p>Do you want to use a <code>PATH_PREFIX</code> clause to restrict file paths for the PDB for the following: directory objects, the Oracle XML repository for the PDB, files created with a <code>CREATE PFILE</code> statement, and the export directory for Oracle wallets?</p> <p>The <code>PATH_PREFIX</code> clause does not affect files created by Oracle Managed Files.</p>	<p>Include a <code>PATH_PREFIX</code> clause that specifies an absolute path.</p>	<p>Set the <code>PATH_PREFIX</code> clause to <code>NONE</code> or omit it.</p>	<p>Creating a PDB from the PDB seed or an application seed</p> <p>Cloning a PDB</p> <p>Relocating a PDB</p> <p>Plugging in an unplugged PDB</p>
<p>Is the PDB a reference PDB with a dependent proxy PDB, and is the port number of its listener changing to a value other than 1521?</p>	<p>Include a <code>PORT</code> clause and specify the port number of the listener for the PDB being created.</p> <p>For example, you might have a listener network for the physical host name and default port and configure a second listener bound to a virtual host name and virtual IP address with a nondefault port number.</p>	<p>Omit the <code>PORT</code> clause.</p>	<p>Creating a PDB from the PDB seed or an application seed</p> <p>Cloning a PDB</p> <p>Relocating a PDB</p> <p>Plugging in an unplugged PDB</p>
<p>Do you want to be able to refresh the PDB to propagate changes from the source PDB to the clone PDB?</p> <p>A refreshable PDB must be opened in read-only mode.</p>	<p>Include a <code>REFRESH MODE MANUAL</code> or <code>REFRESH MODE EVERY minutes</code> clause.</p>	<p>Omit the <code>REFRESH MODE</code> clause or include a <code>REFRESH MODE NONE</code> clause.</p>	<p>Cloning a PDB</p>
<p>Do you want to grant predefined Oracle roles to the <code>PDB_DBA</code> role locally in the PDB?</p> <p>The new administrator for the PDB is granted the <code>PDB_DBA</code> common role locally in the PDB. By default, the <code>CREATE PLUGGABLE DATABASE</code> statement does not grant the administrator or the role any privileges.</p>	<p>Include the <code>ROLES</code> clause and specify the predefined Oracle roles to grant to the <code>PDB_DBA</code> role. The specified roles are granted to the <code>PDB_DBA</code> role locally in the PDB. The user who runs the <code>CREATE PLUGGABLE DATABASE</code> statement does not need to be granted the specified roles. See <i>Oracle Database Security Guide</i> for information about predefined Oracle roles.</p>	<p>Omit the <code>ROLES</code> clause.</p>	<p>Creating a PDB from the PDB seed or an application seed</p> <p>Creating a proxy PDB</p>



**Table 5-3 (Cont.) Clauses for Creating a PDB**

Question	Yes	No	Clause Can Be Used Only When
Do you want to use a <code>SERVICE_NAME_CONVERT</code> clause to rename the user-defined services of the new PDB based on the service names of the source PDB?	Include a <code>SERVICE_NAME_CONVERT</code> clause that specifies the new name of a service and the service name it is replacing. Specify multiple service names and replacement service names if necessary.	Omit the <code>SERVICE_NAME_CONVERT</code> clause.	Creating a PDB from the application seed, but not a PDB seed Cloning a PDB Relocating a PDB Creating a proxy PDB (Only applies to data files in the <code>SYSTEM</code> and <code>SYSAUX</code> tablespaces.) Plugging in an unplugged PDB
Do you want to clone a PDB using a storage snapshot?	Specify a <code>SNAPSHOT COPY</code> clause to indicate that cloning is to be performed using storage snapshots.  Creating a PDB clone with storage snapshots is nearly instantaneous because it does not require copying the data files of the source PDB. <code>SNAPSHOT COPY</code> is supported only if the underlying file system supports storage snapshots.	Omit the <code>SNAPSHOT COPY</code> clause.	Cloning a PDB
Do you want to enable PDB snapshots for the new PDB?	Specify a <code>SNAPSHOT MODE</code> clause and specify <code>MANUAL</code> or <code>EVERY snapshot_interval [MINUTES HOURS]</code> .	Omit the <code>SNAPSHOT MODE</code> clause or specify <code>SNAPSHOT MODE NONE</code> .	Creating a PDB from the PDB seed or an application seed Cloning a PDB Relocating a PDB Creating a proxy PDB (Only applies to data files in the <code>SYSTEM</code> and <code>SYSAUX</code> tablespaces.) Plugging in an unplugged PDB

**Table 5-3 (Cont.) Clauses for Creating a PDB**

Question	Yes	No	Clause Can Be Used Only When
Are all source files in a single directory with new file names that would require multiple <code>SOURCE_FILE_NAME_CONVERT</code> entries?	Specify the <code>SOURCE_FILE_DIRECTORY</code> with the full absolute path to the source files.	Omit the <code>SOURCE_FILE_DIRECTORY</code> clause.	Plugging in an unplugged PDB using an XML file directly.  This clause does not apply to plugging in an unplugged PDB with a <code>.pdb</code> archive file.
Do the contents of the XML file accurately describe the locations of the source files?	Omit the <code>SOURCE_FILE_NAME_CONVERT</code> clause.	Use the <code>SOURCE_FILE_NAME_CONVERT</code> clause to specify the source file locations.	Plugging in an unplugged PDB using an XML file directly.  This clause does not apply to plugging in an unplugged PDB with a <code>.pdb</code> archive file.
Do you want to include the new PDB in one or more standby CDBs?	Specify <code>ALL</code> , <code>ALL EXCEPT</code> , or a list of standby CDBs.  When creating a remote clone, you can set the initialization parameter <code>STANDBY_PDB_SOURCE_FILE_DBLINK</code> to the name of the database link that points to the source PDB data files. The operation copies the data files only if the source PDB is open read-only.	Omit the <code>STANDBYS</code> clause or specify <code>NONE</code> .	Creating a PDB from the PDB seed or an application seed Cloning a PDB Relocating a PDB Plugging in an unplugged PDB
Do you want to limit the amount of storage that the PDB can use?	Specify a <code>STORAGE</code> clause with the appropriate limits.	Omit the <code>STORAGE</code> clause, or specify unlimited storage using the <code>STORAGE</code> clause.	Creating a PDB from the PDB seed or an application seed Cloning a PDB Relocating a PDB Plugging in an unplugged PDB
Do you want to reuse the temp file if a temp file exists in the target location?	Include the <code>TEMPFILE REUSE</code> clause.	Omit the <code>TEMPFILE REUSE</code> clause.  Ensure that there is no file with the same name as the new temp file in the target location.	Creating a PDB from the PDB seed or an application seed Cloning a PDB Relocating a PDB Plugging in an unplugged PDB

Table 5-3 (Cont.) Clauses for Creating a PDB

Question	Yes	No	Clause Can Be Used Only When
Do you want to specify which tablespaces are included in the new PDB and which tablespaces are excluded from the new PDB?	Include the <code>USER_TABLESPACES</code> clause and specify the tablespaces that are included in the new PDB.	Omit the <code>USER_TABLESPACES</code> clause.	Cloning a non-CDB Plugging in an unplugged PDB
Do you want to plug an unplugged PDB into a CDB?	Include the <code>USING filename</code> clause.  If you are plugging in a PDB to a primary CDB in a Data Guard scenario, then set the <code>STANDBY_PDB_SOURCE_FILE_DIRECTORY</code> initialization parameter to a standby location that contains the source data files for instantiating the PDB. If not found, then the standby database tries to locate the files in the OMF location. If not found in the OMF location, then copy the data files to the OMF location, and restart redo apply on the standby database.	Omit the <code>USING filename</code> clause.	Plugging in an unplugged PDB
Do you want to create a new PDB based on a PDB snapshot?	Include the <code>USING SNAPSHOT</code> clause and specify either the PDB snapshot name, SCN, or timestamp.	Exclude the <code>USING SNAPSHOT</code> clause.	Cloning a PDB snapshot
Do you want to clone a PDB that resides in Oracle ASM by splitting a mirror?	Include the <code>USING MIRROR COPY</code> clause and specify the name of the mirror copy and the source PDB.	Omit the <code>USING MIRROR COPY</code> clause.	Cloning a PDB that uses Oracle ASM storage

## 5.5 General Prerequisites for PDB Creation

Before creating a PDB, you must meet certain prerequisites.

Ensure that the following prerequisites are met before creating a PDB.

Table 5-4 Prerequisites for Creating PDBs

Prerequisite	See Also
The CDB must exist.	" <a href="#">Creating and Configuring a CDB</a> "
The CDB must be in read/write mode.	" <a href="#">Modifying the Open Mode of One or More PDBs</a> "
The current user must be a common user whose current container is the CDB root or an application container.	" <a href="#">Common Users in a CDB</a> "

Table 5-4 (Cont.) Prerequisites for Creating PDBs

Prerequisite	See Also
The current user must have the CREATE PLUGGABLE DATABASE system privilege.	<a href="#">"How Commonly Granted System Privileges Work"</a>
You must decide on a unique container name for each container. Each container name must be unique in a single CDB, and each container name must be unique within the scope of all the CDBs whose instances are reached through a specific listener.  The PDB name distinguishes a PDB from other PDBs in the CDB. PDB names follow the same rules as service names, which includes being case-insensitive.	<i>Oracle Database Net Services Reference</i> to learn the rules for service names
If you are creating a PDB in an Oracle Data Guard configuration with a physical standby database, then you must complete additional tasks before creating a PDB.	<i>Oracle Data Guard Concepts and Administration</i> for more information
If you are creating a PDB that includes data that was encrypted with Transparent Data Encryption, then you must complete additional tasks.	<i>Oracle Database Advanced Security Guide</i> for instructions
If you are creating a Database Vault-enabled PDB, then you must complete additional tasks.	<i>Oracle Database Vault Administrator's Guide</i> for instructions
If you are creating a PDB by cloning a non-CDB, and if you want the ability to recover the new PDB using backups of the source non-CDB, then you <i>must</i> execute <code>DBMS_PDB.EXPORTMANBACKUP</code> before cloning. When the source database is opened in read-write mode, execute the procedure as the last step before cloning. This procedure captures all backup metadata in the data dictionary.  When relocating a PDB to a different CDB, executing <code>DBMS_PDB.EXPORTMANBACKUP</code> is not necessary. Unplugging the PDB automatically exports the backup metadata.	<i>Oracle Database Backup and Recovery User's Guide</i> for instructions

**See Also:**

- ["About the Current Container"](#)
- *Oracle Database PL/SQL Packages and Types Reference* to learn more about `DBMS_PDB.EXPORTMANBACKUP`

# 6

## Creating a PDB from Scratch

Use the `CREATE PLUGGABLE DATABASE` statement to create a PDB in a CDB using the files of the PDB seed (`PDB$SEED`).

You can also use this statement to create an application PDB in an application container using the files of an application seed or the PDB seed.

This chapter contains the following topics:

- [About Creating a PDB from Scratch](#)  
Use the `CREATE PLUGGABLE DATABASE` statement to create a new PDB by using the files of the PDB seed or an application PDB from the files of an application seed or the PDB seed.
- [Creating a PDB](#)  
Using the `CREATE PLUGGABLE DATABASE` statement, you can create a PDB from the PDB seed, and you can create an application PDB from an application seed or the PDB seed.
- [Creating a PDB: Examples](#)  
These examples create a new PDB named `salespdb` and a `salesadm` local administrator given different factors.

### See Also:

*Oracle Database SQL Language Reference* for more information about the `CREATE PLUGGABLE DATABASE` statement

### 6.1 About Creating a PDB from Scratch

Use the `CREATE PLUGGABLE DATABASE` statement to create a new PDB by using the files of the PDB seed or an application PDB from the files of an application seed or the PDB seed.

The statement copies these files to a new location and associates them with the new PDB. The following figure illustrates how this technique creates a new PDB in a CDB with the CDB root as the current container.

Figure 6-1 Create a PDB in the CDB Root Using the PDB\$SEED Files

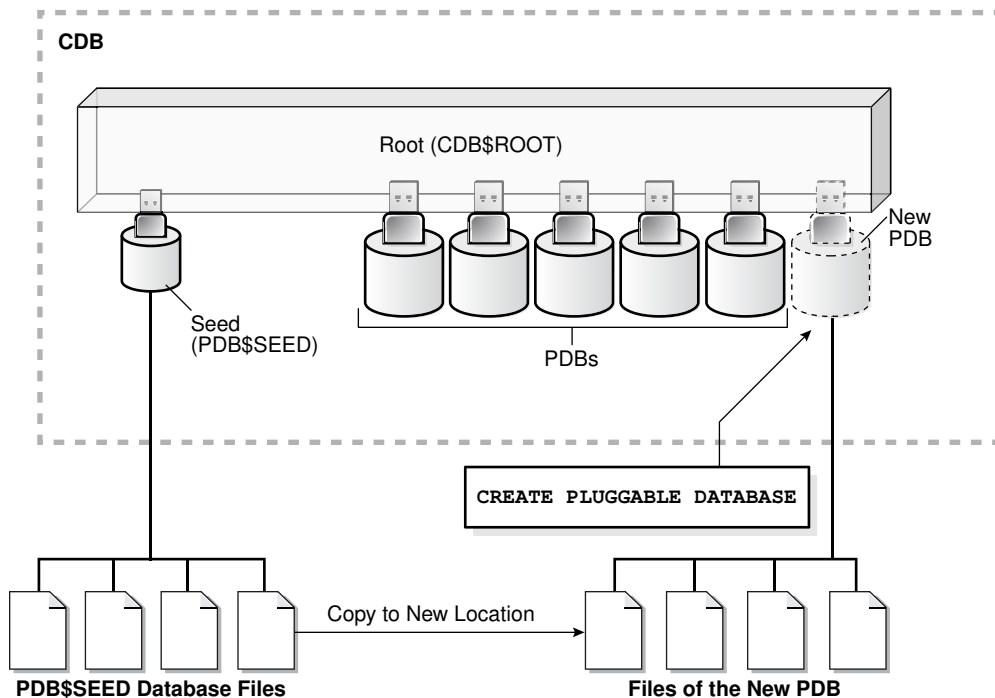

The following figure illustrates how this technique creates a new application PDB in an application container with the application root as the current container.

**Figure 6-2 Create a PDB in an Application Root Using the Application Seed Files**

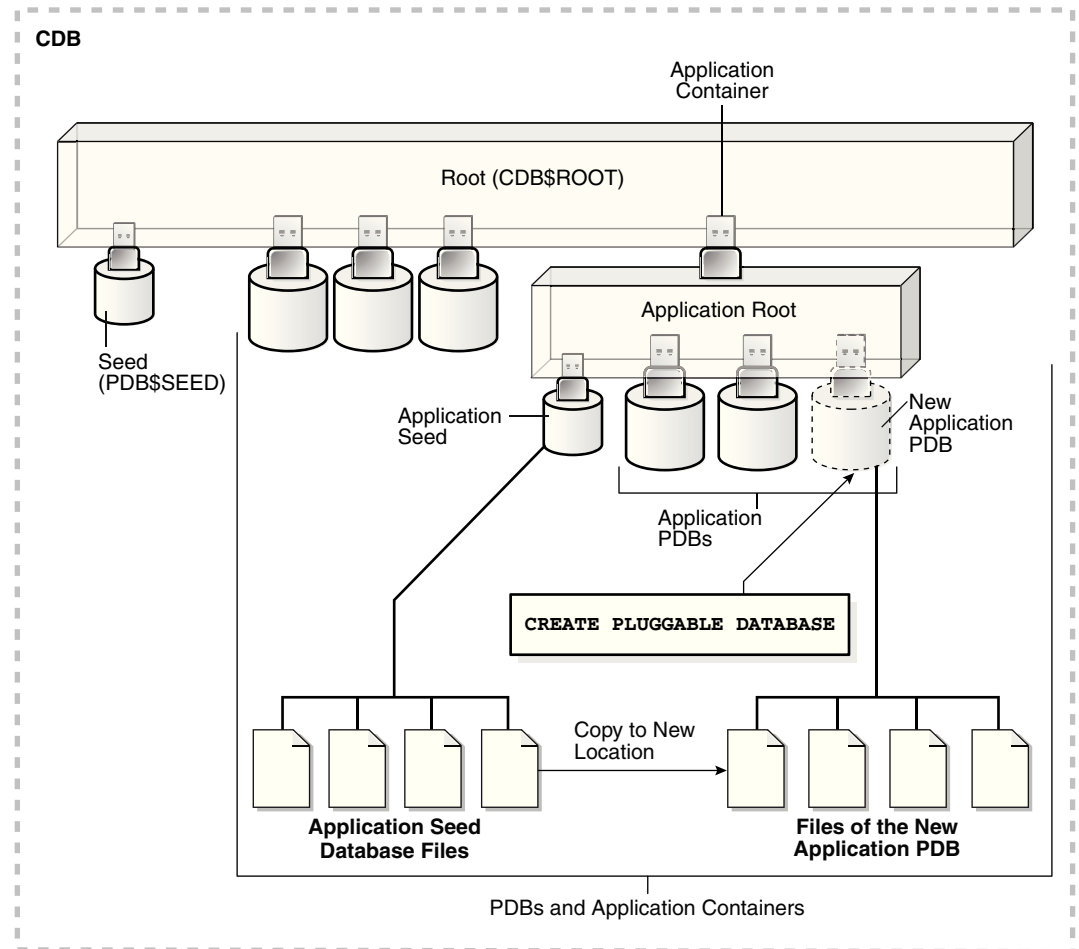

 **See Also:**

When an application container includes an application seed, and a `CREATE PLUGGABLE DATABASE` statement is run in the application root to create an application PDB from the seed, the application PDB is created using the application seed. However, when an application container does not include an application seed, and a `CREATE PLUGGABLE DATABASE` statement is run in the application root to create an application PDB from the seed, the application PDB is created using the PDB seed (`PDB$SEED`).

When you create a new PDB or application PDB from the seed, you must specify an administrator for the PDB or application PDB in the `CREATE PLUGGABLE DATABASE` statement. The statement creates the administrator as a local user in the PDB and grants the `PDB_DBA` role locally to the administrator.

Before creating a PDB using the PDB seed or an application seed, address the questions that apply to creating a PDB from the seed in [Table 5-3](#). The table describes

which `CREATE PLUGGABLE DATABASE` clauses you must specify based on different factors.

 **See Also:**

- ["PDB Storage"](#)
- ["Creating an Application PDB"](#)

## 6.2 Creating a PDB

Using the `CREATE PLUGGABLE DATABASE` statement, you can create a PDB from the PDB seed, and you can create an application PDB from an application seed or the PDB seed.

### Prerequisites

Before creating a PDB from the PDB seed (`PDB$SEED`) or an application PDB from an application seed or the PDB seed, complete the prerequisites described in ["General Prerequisites for PDB Creation"](#).

### To create a PDB:

1. In SQL\*Plus, ensure that the current container is the CDB root or an application root.

When the current container is the CDB root, the PDB is created in the CDB using the files of the PDB seed.

When the current container is an application root, the application PDB is created in the application container using the files of the application seed. If there is no application seed in the application container, then the application PDB is created in the application container using the files of the PDB seed.

2. Run the `CREATE PLUGGABLE DATABASE` statement, and specify a local administrator for the PDB. Specify other clauses when they are required.

After you create the PDB, it is in mounted mode, and its status is `NEW`. You can view the open mode of a PDB by querying the `OPEN_MODE` column in the `V$PDBS` view. You can view the status of a PDB by querying the `STATUS` column of the `CDB_PDBS` or `DBA_PDBS` view.

A new default service is created for the PDB. The service has the same name as the PDB and can be used to access the PDB. Oracle Net Services must be configured properly for clients to access this service.

3. Open the new PDB in read/write mode.

You must open the new PDB in read/write mode for Oracle Database to complete the integration of the new PDB into the CDB. An error is returned if you attempt to open the PDB in read-only mode. After the PDB is opened in read/write mode, its status is `NORMAL`.

4. Back up the PDB.

A PDB cannot be recovered unless it is backed up.



A local user with the name of the specified local administrator is created and granted the `PDB_DBA` common role locally in the PDB. If this user was not granted administrator privileges during PDB creation, then use the `SYS` and `SYSTEM` common users to administer to the PDB.

 **Note:**

If an error is returned during PDB creation, then the PDB being created might be in an `UNUSABLE` state. You can check a PDB's state by querying the `CDB_PDBS` or `DBA_PDBS` view, and you can learn more about PDB creation errors by checking the alert log. An unusable PDB can only be dropped, and it must be dropped before a PDB with the same name as the unusable PDB can be created.

 **See Also:**

- ["About Container Access in a CDB"](#)
- ["Modifying the Open Mode of One or More PDBs"](#) for more information
- *Oracle Database Backup and Recovery User's Guide* for information about backing up a PDB

## 6.3 Creating a PDB: Examples

These examples create a new PDB named `salespdb` and a `salesadm` local administrator given different factors.

In addition to creating the `salespdb` PDB, this statement grants the `PDB_DBA` role to the PDB administrator `salesadm` and grants the specified predefined Oracle roles to the `PDB_DBA` role locally in the PDB.

In each example, the root to which the new PDB belongs depends on the current container when the `CREATE PLUGGABLE DATABASE` statement is run:

- When the current container is the CDB root, the new PDB is created in the CDB root.
- When the current container is an application root in an application container, the new PDB is created as an application PDB in the application root.

This section contains the following examples:

- [Creating a PDB Using No Clauses: Example](#)  
This example shows the simplest way to create a PDB.
- [Creating a PDB and Granting Predefined Oracle Roles to the PDB Administrator: Example](#)  
This example uses the `ROLES` parameter to grant a predefined role.

- [Creating a PDB Using Multiple Clauses: Example](#)  
This example creating a PDB using the `STORAGE`, `DEFAULT TABLESPACE`, `PATH_PREFIX`, and `FILE_NAME_CONVERT` clauses.

### 6.3.1 Creating a PDB Using No Clauses: Example

This example shows the simplest way to create a PDB.

This example assumes the following factors:

- Storage limits are not required for the PDB. Therefore, the `STORAGE` clause is not required.
- The PDB does not require a default tablespace.
- The `PATH_PREFIX` clause is not required.
- The `FILE_NAME_CONVERT` clause and the `CREATE_FILE_DEST` clause are not required.

Either Oracle Managed Files is enabled for the CDB, or the `PDB_FILE_NAME_CONVERT` initialization parameter is set. The files associated with the PDB seed or application seed will be copied to a new location based on the Oracle Managed Files configuration or the initialization parameter setting.

- There is no file with the same name as the new temp file that will be created in the target location. Therefore, the `TEMPFILE REUSE` clause is not required.
- No predefined Oracle roles need to be granted to the `PDB_DBA` role.

The following statement creates the PDB:

```
CREATE PLUGGABLE DATABASE salespdb ADMIN USER salesadm IDENTIFIED BY  
password;
```

#### See Also:

- *Oracle Database Administrator's Guide* for information about using Oracle Managed Files
- *Oracle Database Reference* for information about the `PDB_FILE_NAME_CONVERT` initialization parameter
- *Oracle Database Security Guide* for guidelines about choosing passwords

### 6.3.2 Creating a PDB and Granting Predefined Oracle Roles to the PDB Administrator: Example

This example uses the `ROLES` parameter to grant a predefined role.

This example assumes the following factors:

- Storage limits are not required for the PDB. Therefore, the `STORAGE` clause is not required.
- The PDB does not require a default tablespace.
- The `PATH_PREFIX` clause is not required.
- The `FILE_NAME_CONVERT` clause and the `CREATE_FILE_DEST` clause are not required.

Either Oracle Managed Files is enabled, or the `PDB_FILE_NAME_CONVERT` initialization parameter is set. The files associated with the PDB seed or application seed will be copied to a new location based on the Oracle Managed Files configuration or the initialization parameter setting.

- There is no file with the same name as the new temp file that will be created in the target location. Therefore, the `TEMPFILE REUSE` clause is not required.
- The `PDB_DBA` role should be granted the following predefined Oracle role locally: `DBA`.

The following statement creates the PDB:

```
CREATE PLUGGABLE DATABASE salespdb
  ADMIN USER salesadm IDENTIFIED BY password
  ROLES=(DBA);
```

#### See Also:

- *Oracle Database Administrator's Guide* for information about using Oracle Managed Files
- *Oracle Database Reference* for information about the `PDB_FILE_NAME_CONVERT` initialization parameter
- *Oracle Database Security Guide* for guidelines about choosing passwords

### 6.3.3 Creating a PDB Using Multiple Clauses: Example

This example creating a PDB using the `STORAGE`, `DEFAULT TABLESPACE`, `PATH_PREFIX`, and `FILE_NAME_CONVERT` clauses.

This example assumes the following factors:

- Storage limits must be enforced for the PDB. Therefore, the `STORAGE` clause is required. Specifically, all tablespaces that belong to the PDB must not exceed 2 gigabytes.
- A default permanent tablespace is required for any non-administrative users for which you do not specify a different permanent tablespace. Specifically, this example creates a default permanent tablespace named `sales` with the following characteristics:
  - The single data file for the tablespace is `sales01.dbf`, and the statement creates it in the `/disk1/oracle/dbs/salespdb` directory.

- The `SIZE` clause specifies that the initial size of the tablespace is 250 megabytes.
- The `AUTOEXTEND` clause enables automatic extension for the file.
- The path prefix must be added to the PDB directory object paths. Therefore, the `PATH_PREFIX` clause is required. In this example, the path prefix `/disk1/oracle/dbs/salespdb/` is added to the PDB's directory object paths.
- The `CREATE_FILE_DEST` clause will not be used, Oracle Managed Files is not enabled, and the `PDB_FILE_NAME_CONVERT` initialization parameter is not set. Therefore, the `FILE_NAME_CONVERT` clause is required. Specify the location of the data files for the PDB seed or application seed on your system. In this example, Oracle Database copies the files from `/disk1/oracle/dbs/pdbseed` to `/disk1/oracle/dbs/salespdb`.
- There is no file with the same name as the new temp file that will be created in the target location. Therefore, the `TEMPFILE REUSE` clause is not required.
- No predefined Oracle roles need to be granted to the `PDB_DBA` role.

The following statement creates the PDB:

```
CREATE PLUGGABLE DATABASE salespdb
  ADMIN USER salesadm IDENTIFIED BY password
  STORAGE (MAXSIZE 2G)
  DEFAULT TABLESPACE sales
  DATAFILE '/disk1/oracle/dbs/salespdb/sales01.dbf' SIZE 250M AUTOEXTEND
ON
  PATH_PREFIX = '/disk1/oracle/dbs/salespdb/'
  FILE_NAME_CONVERT = ('/disk1/oracle/dbs/pdbseed/', '/disk1/oracle/dbs/
salespdb/');
```

#### See Also:

- "[Example 19-7](#)" to learn how to view the location of the data files for the PDB seed or application seed
- *Oracle Database SQL Language Reference* for more information about the `DEFAULT TABLESPACE` clause
- *Oracle Database Security Guide* for guidelines about choosing passwords

# 7

## Cloning a PDB or Non-CDB

You can create a PDB by cloning a local PDB, a remote PDB, or a non-CDB.

This chapter contains the following topics:

- [About Cloning a PDB](#)  
To clone a PDB from a source PDB or from a non-CDB, use the `CREATE PLUGGABLE DATABASE` statement.
- [Cloning a Local PDB: Basic Steps](#)  
You can clone a local PDB by executing `CREATE PLUGGABLE DATABASE` and specify the source PDB in the `FROM` clause.
- [Cloning a Local PDB: Examples](#)  
The following examples clone a local source PDB named `pdb1` to a target PDB named `pdb2` given different factors.
- [Cloning a Remote PDB: Basic Steps](#)  
You can create a PDB by cloning a remote PDB. After the cloning operation, the source and the target PDB are in different locations.
- [Cloning a Remote PDB or Non-CDB: Examples](#)  
These examples clone a remote PDB or non-CDB given different factors.
- [After Cloning a PDB](#)  
Certain rules regarding users and tablespaces apply after cloning a PDB.
- [Materializing a Snapshot Copy PDB](#)  
You can materialize a snapshot copy PDB by running an `ALTER PLUGGABLE DATABASE` statement with the `MATERIALIZED` clause. Materializing a snapshot copy PDB copies all data blocks.

### 7.1 About Cloning a PDB

To clone a PDB from a source PDB or from a non-CDB, use the `CREATE PLUGGABLE DATABASE` statement.

This technique clones a source PDB or non-CDB as a new PDB and automatically plugs the clone into the CDB. To use this technique, you must include a `FROM` clause that specifies the source. The source is the existing PDB or non-CDB that you want to clone. The target PDB is the clone of the source. The source can be any of the following:

- Local PDB
- PDB in a remote CDB
- Non-CDB

The `CREATE PLUGGABLE DATABASE` statement copies the files associated with the source to a new location and associates the files with the target PDB. When the CDB is in `ARCHIVELOG` mode and local undo mode, the source PDB can be open in read/

write mode and operational during the cloning process. This technique is known as **hot cloning**.

 **Note:**

If you clone a PDB, and if the source database has encrypted data or a keystore set, then you must provide the keystore password by including the keystore identified by *keystore\_password* clause in the `CREATE PLUGGABLE DATABASE ... FROM SQL` statement. You must provide this password even if the source database is using an auto-login software keystore. You can determine whether the source database has encrypted data or a keystore by querying the `DBA_ENCRYPTED_COLUMNS` data dictionary view.

A typical use for cloning is creation of test PDBs. Cloning enables you to create one or more clones of a PDB or non-CDB and safely test them in isolation. For example, you might test a new or modified application on a cloned PDB before using the application with a production PDB.

This section contains the following topics:

- [About Cloning a Local PDB](#)  
The simplest form of cloning copies a PDB from a CDB into the same CDB.
- [About Cloning a Remote PDB](#)  
When the source is a PDB in a remote CDB, you must use a database link to clone the PDB into the local CDB.
- [About Cloning a Non-CDB](#)  
When the source is a non-CDB, you must specify a database link to the non-CDB in the `FROM` clause.
- [About Cloning an Application PDB](#)  
In all cloning scenarios, when you run the `CREATE PLUGGABLE DATABASE` statement in the application root, the cloned PDB is created in the application container.
- [About Refreshable Clone PDBs](#)  
The `CREATE PLUGGABLE DATABASE ... REFRESH MODE` statement clones a source PDB and configures the clone to be refreshable. Refreshing the clone PDB updates it with redo accumulated since the last redo log apply.
- [About Cloning PDBs from PDB Snapshots](#)  
A **PDB snapshot** is a database-managed, point-in-time copy of a PDB. A **snapshot clone PDB** is a PDB created from a snapshot.
- [About Snapshot Copy PDBs](#)  
A **snapshot copy PDB** is a PDB that has been created using a `CREATE PLUGGABLE DATABASE ... SNAPSHOT COPY` statement.
- [About Split Mirror Clone PDBs](#)  
In Oracle ASM, a split mirror is the process of detaching a point-in-time media copy from a parent copy. After the split, updates to the parent do not affect the child copy.

**See Also:**

*Oracle Database Advanced Security Guide* to learn about cloning a source with encrypted data or a keystore set

## 7.1.1 About Cloning a Local PDB

The simplest form of cloning copies a PDB from a CDB into the same CDB.

**Note:**

You cannot use the `FROM` clause in the `CREATE PLUGGABLE DATABASE` statement to create a PDB from the PDB seed (`PDB$SEED`) or from an application seed.

The following figure illustrates how to clone a local PDB.

**Figure 7-1 Clone a Local PDB**

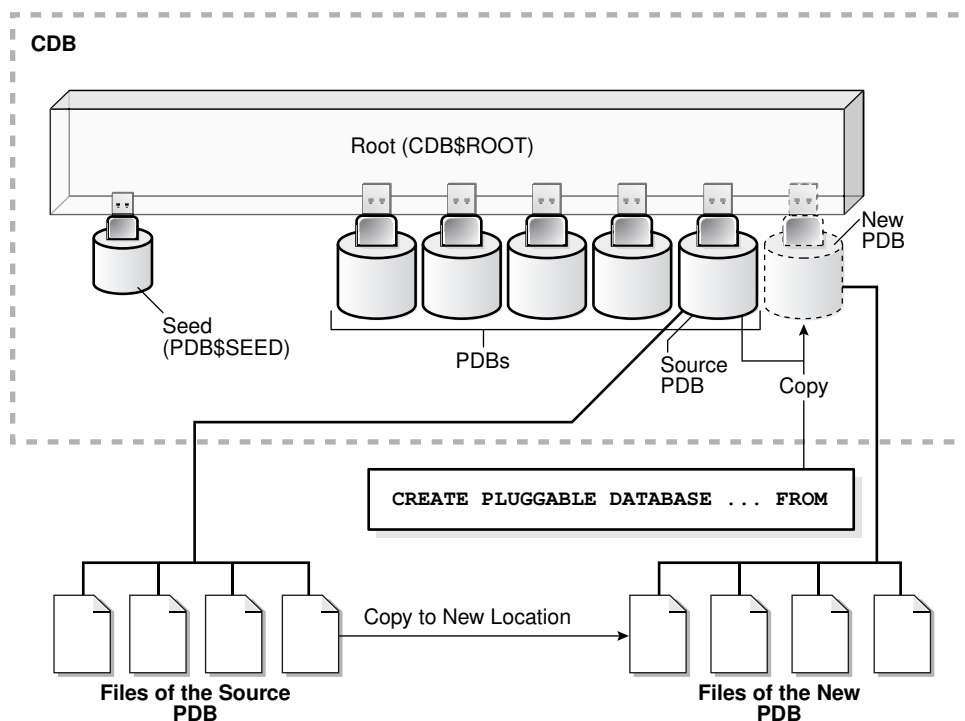

Before cloning a PDB, address the questions that apply to cloning a PDB in "Table 5-3". The table describes which `CREATE PLUGGABLE DATABASE` clauses to specify based on different factors.

Starting in Oracle Database 18c, you can clone a local PDB using DBCA.

 **See Also:**

- ["Determining the Current Container ID or Name"](#)
- ["Creating a PDB from Scratch"](#) to learn how to create a PDB from the seed
- ["Cloning a Local PDB Using DBCA: Example"](#)
- ["Creating an Application PDB"](#)

## 7.1.2 About Cloning a Remote PDB

When the source is a PDB is in a remote CDB, you must use a database link to clone the PDB into the local CDB.

The database link must exist in the *local* CDB (not the remote CDB). When you issue the `CREATE PLUGGABLE DATABASE` statement from the root of the local CDB, you must specify a database link to the remote CDB that contains the PDB being cloned in the `FROM` clause. The database link connects from the local CDB to either to the root of the remote CDB or to the remote source PDB.

The following figure illustrates how this technique creates a new PDB when the source PDB is remote.



Figure 7-2 Creating a PDB by Cloning a Remote PDB

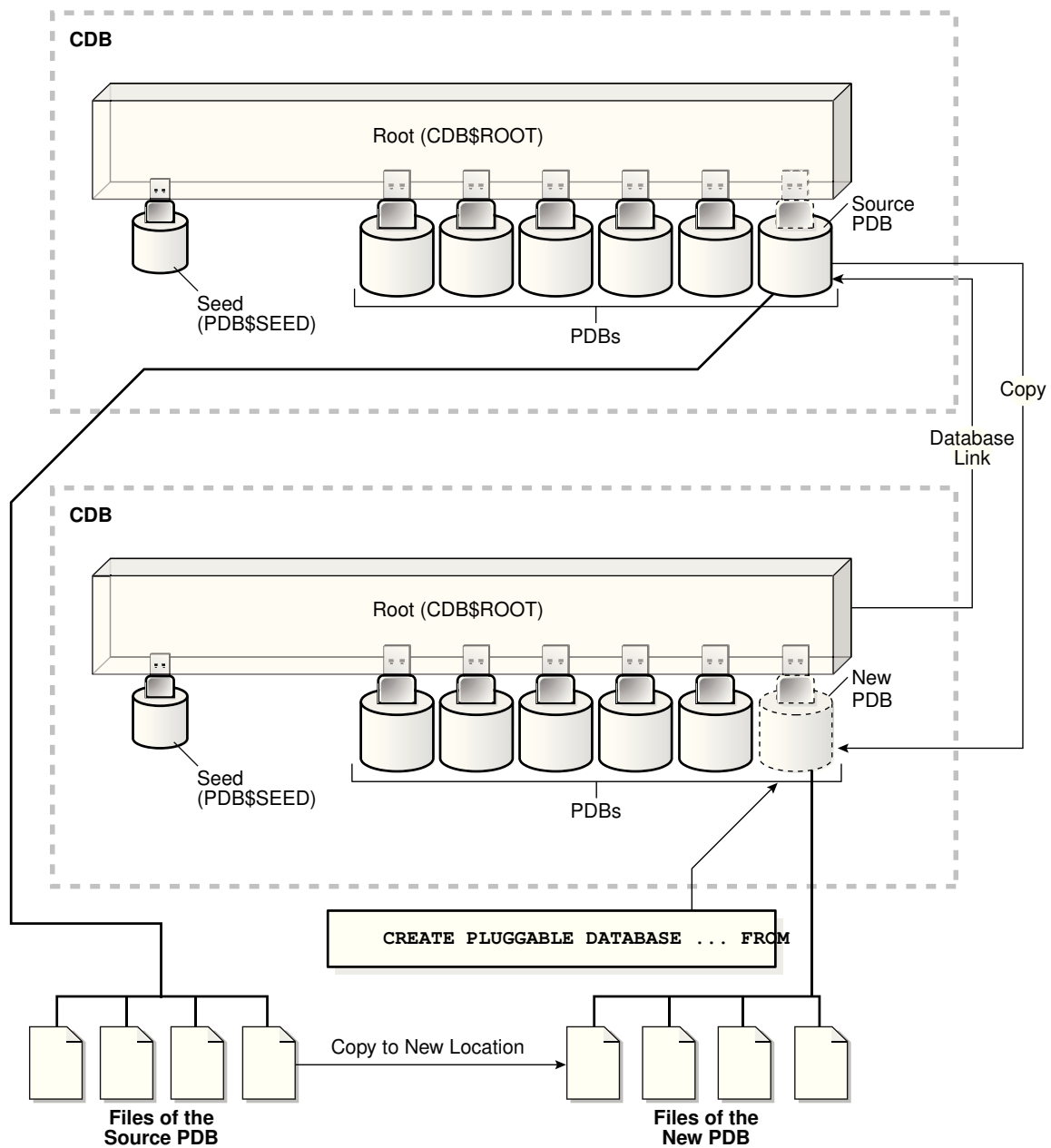

### 7.1.3 About Cloning a Non-CDB

When the source is a non-CDB, you must specify a database link to the non-CDB in the `FROM` clause.

The following figure illustrates how this technique creates a new PDB when the source is a remote non-CDB.

Figure 7-3 Creating a PDB by Cloning a Non-CDB

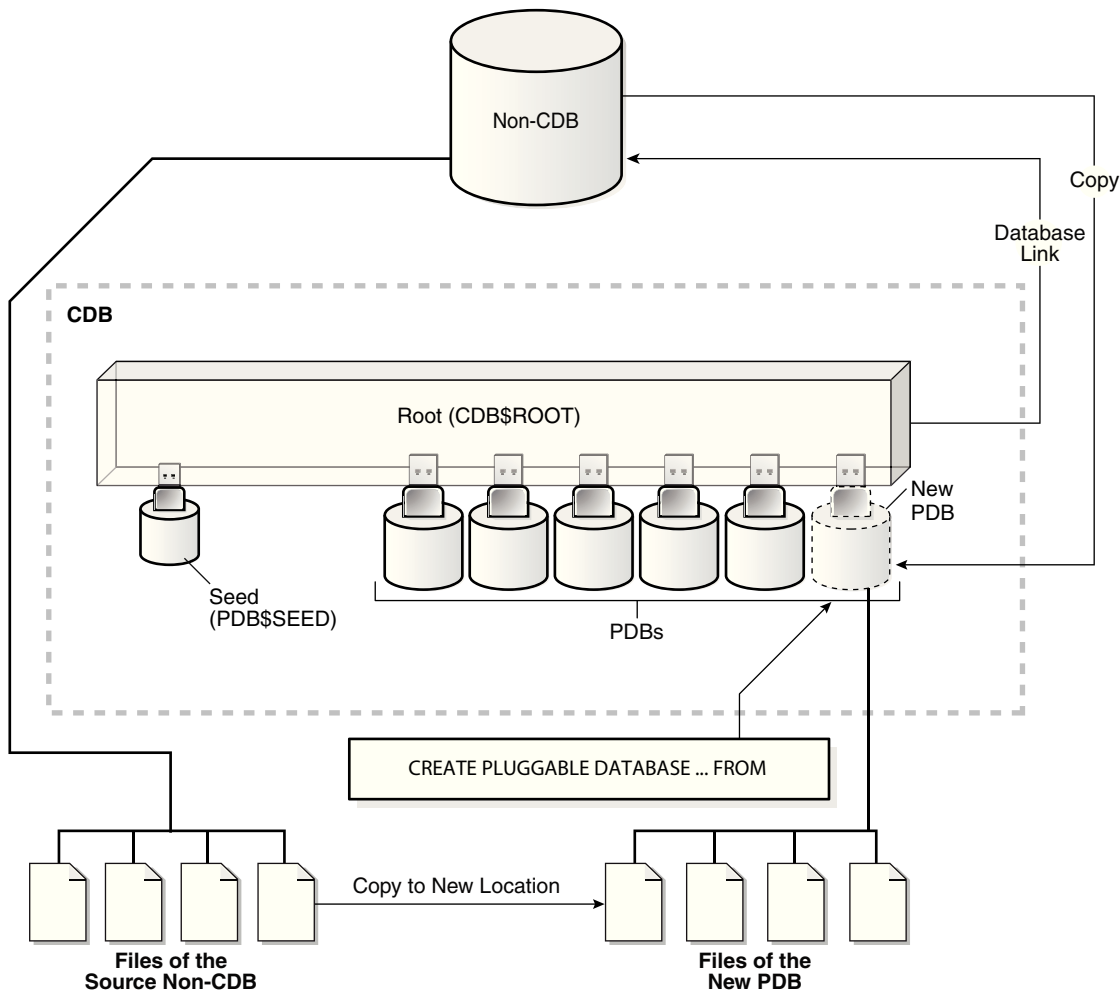

## 7.1.4 About Cloning an Application PDB

In all cloning scenarios, when you run the `CREATE PLUGGABLE DATABASE` statement in the application root, the cloned PDB is created in the application container.

The application name and version of the source PDB must match the application name and version of the application container.

The following graphic illustrates how this technique creates a new application PDB in an application container by cloning a local source application PDB. The source PDB can also be a PDB plugged into the local CDB root, a PDB plugged into a remote CDB root, or an application PDB plugged into a remote application root.

Figure 7-4 Clone a PDB in an Application Container

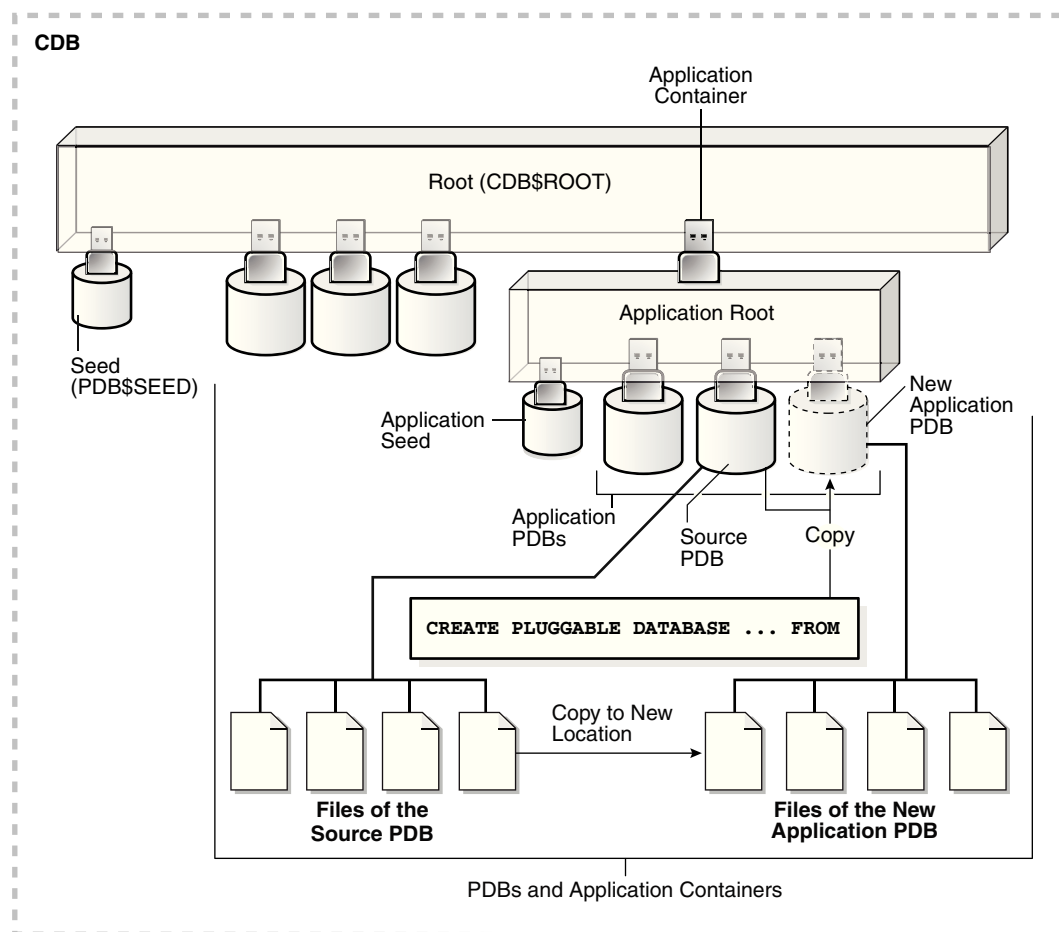

 **See Also:**  
"PDB Storage"

## 7.1.5 About Refreshable Clone PDBs

The `CREATE PLUGGABLE DATABASE ... REFRESH MODE` statement clones a source PDB and configures the clone to be refreshable. Refreshing the clone PDB updates it with redo accumulated since the last redo log apply.

This section contains the following topics:

- [Purpose of Refreshable Clone PDBs](#)  
The cloning operation for production PDBs can take a long time.
- [Automatic and Manual Refresh Modes](#)  
You can configure the clone PDB to refresh automatically at set intervals, or you can refresh it manually with the `ALTER PLUGGABLE DATABASE REFRESH` statement.

- [Requirements for Refreshable Clone PDBs](#)  
Creation of a refreshable clone PDB requires a database link. The database link can point to the same CDB or a different CDB.

### 7.1.5.1 Purpose of Refreshable Clone PDBs

The cloning operation for production PDBs can take a long time.

If PDBs are cloned infrequently to avoid a drag on the system, then the clone data becomes stale. A refreshable clone PDB solves this problem. When a refreshable clone is stale, you can quickly refresh it with recent redo. A typical practice is to maintain a “golden master” refreshable clone of a production PDB, and then take snapshot clones of the golden master for development and testing.

You can reverse the roles for source and clone PDBs using an `ALTER PLUGGABLE DATABASE ... SWITCHOVER` statement. This capability is useful in the following situations:

- **Planned switchover**  
The CDB hosting the source PDB may experience significantly more overhead than the CDB hosting the clone PDB. To achieve load balancing, you can reverse the roles, making the clone the new source PDB, and the source PDB the new clone.
- **Unplanned switchover**  
The source PDB may suffer an unplanned failure. In this case, you can make the clone PDB the new source PDB, and resume normal operations.

#### See Also:

- ["Managing Refreshable Clone PDBs"](#)
- *Oracle Database SQL Language Reference* to learn more about `ALTER PLUGGABLE DATABASE ... SWITCHOVER`

### 7.1.5.2 Automatic and Manual Refresh Modes

You can configure the clone PDB to refresh automatically at set intervals, or you can refresh it manually with the `ALTER PLUGGABLE DATABASE REFRESH` statement.

The `REFRESH MODE` clause is supported only in a `CREATE PLUGGABLE DATABASE ... FROM` statement. You can use this clause to specify one of the following options:

- Specify `REFRESH MODE NONE`, the default, to create a PDB that is not refreshable.  
You can change a refreshable clone PDB into an ordinary PDB by including the `REFRESH MODE NONE` clause in an `ALTER PLUGGABLE DATABASE` statement and then opening the PDB in read/write mode. You cannot change an ordinary PDB into a refreshable clone PDB. After a refreshable clone PDB is converted to an ordinary PDB, you cannot change it back into a refreshable clone PDB.
- Specify `REFRESH MODE MANUAL` to create a refreshable PDB that must be refreshed manually.

- Specify `REFRESH MODE EVERY number_of_minutes MINUTES` to create a refreshable PDB that is refreshed automatically after the specified number of minutes has passed. A refreshable PDB that uses automatic refresh can also be refreshed manually.

 **Note:**

- When you create a refreshable PDB, you can set the `REMOTE_RECOVERY_FILE_DEST` initialization parameter in the PDB. This initialization parameter specifies a directory from which to read archive log files during refresh operations if the source PDB is not available over its database link.
- If new data files are created in the source PDB, then the `PDB_FILE_NAME_CONVERT` initialization parameter must be set in the CDB to convert the data file paths from the source PDB to the clone PDB.

**Example 7-1 A REFRESH MODE Clause That Specifies Automatic Refresh**

This refresh mode clause specifies that a refreshable PDB is refreshed automatically every two hours (120 minutes):

```
REFRESH MODE EVERY 120 MINUTES
```

 **See Also:**

- ["Cloning a Remote PDB: Basic Steps"](#)
- ["Refreshing a PDB"](#)

### 7.1.5.3 Requirements for Refreshable Clone PDBs

Creation of a refreshable clone PDB requires a database link. The database link can point to the same CDB or a different CDB.

A refreshable clone PDB must be in either of the following states:

- Closed

A refreshable PDB must be closed when a refresh is performed. If it is not closed when automatic refresh is attempted, then the refresh is deferred until the next scheduled refresh. If it is not closed when a user attempts to perform manual refresh, then an error is reported.
- Open in read-only mode

The refreshable PDB must be kept in read-only mode to prevent out-of-sync changes on the refreshable PDB which do not occur on the source PDB. The refreshable PDB is intended to serve as a clone master and as such must accurately reflect the source PDB at the refreshed point in time.

## 7.1.6 About Cloning PDBs from PDB Snapshots

A **PDB snapshot** is a database-managed, point-in-time copy of a PDB. A **snapshot clone PDB** is a PDB created from a snapshot.

Starting in Oracle Database 19c, the behavior of PDB snapshots depends on the setting of the `CLONEDB` initialization parameter:

- `CLONEDB=TRUE`  
You can take snapshots of PDBs that are in read/write mode or read-only mode. The first snapshot of the PDB contains full copies of the original PDB files, but subsequent snapshots of the same PDB contain sparse files.
- `CLONEDB=FALSE`  
You can only take snapshots of read-only PDBs. Every snapshot is a full copy of the source PDB files. In this case, if you create a clone PDB based on a PDB snapshot, then the source PDB must remain read-only for the lifetime of the clone PDB.

 **Note:**

See *Oracle Database Licensing Information User Manual* for details on which features are supported for different editions and services.

### PDB Snapshot Carousel

A PDB snapshot carousel is a library of up to 8 snapshots. The carousel enables you to perform a “hot clone” of a PDB to a specific SCN or point in time. A use case is to restore a snapshot from the carousel, typically the most recent snapshot, and then recover it to the required SCN or timestamp.

### Cloning a PDB from a PDB Snapshot

The `USING SNAPSHOT` clause of the `CREATE PLUGGABLE DATABASE` statement creates an active PDB from an existing PDB snapshot. To view the available PDB snapshots, query the `DBA_PDB_SNAPSHOTS` data dictionary view.

To clone a PDB from a snapshot, specify one of the following values in the `USING SNAPSHOT` clause:

- The PDB snapshot name
- The PDB snapshot SCN in the following form:

```
USING SNAPSHOT AT SCN scn
```

- The PDB snapshot timestamp in the following form:

```
USING SNAPSHOT AT TIME timestamp
```

If the PDB snapshot is a sparse copy (that is, it was created when `CLONEDB=TRUE` and was not the first snapshot taken of the source PDB), then the PDB cloned from this snapshot is also sparse.

#### See Also:

- ["User Interface for PDB Snapshot Carousel"](#)
- *Oracle Database SQL Language Reference* for the syntax and semantics of the `USING SNAPSHOT` clause
- *Oracle Database Licensing Information User Manual* for details on which features are supported for different editions and services

## 7.1.7 About Snapshot Copy PDBs

A **snapshot copy PDB** is a PDB that has been created using a `CREATE PLUGGABLE DATABASE ... SNAPSHOT COPY` statement.

This section contains the following topics:

- [How a Snapshot Copy PDB Differs from a Standard Clone](#)  
A snapshot copy PDB and a PDB snapshot created with the `USING SNAPSHOT` clause are distinct types of snapshots.
- [Storage Requirements for Snapshot Copy PDBs](#)  
When you specify the `SNAPSHOT COPY` clause in `CREATE PLUGGABLE DATABASE ... FROM sourcepdb`, all data files of the source PDB must reside in the same storage type.

### 7.1.7.1 How a Snapshot Copy PDB Differs from a Standard Clone

A snapshot copy PDB and a PDB snapshot created with the `USING SNAPSHOT` clause are distinct types of snapshots.

A snapshot copy PDB does not include a complete copy of the source data files. Rather, Oracle Database creates a storage-level snapshot of the underlying file system, and then creates the clone PDB from the snapshot.

Unlike a standard clone PDB, the snapshot copy PDB is dependent on the storage snapshot. Therefore, you cannot unplug this PDB from the CDB root or plug it in to an application root. Also, you cannot drop the storage snapshot on which the PDB is based. Instead, you must materialize the snapshot copy PDB, which converts it into a full PDB with non-sparse files.

In contrast, the `USING SNAPSHOT` clause creates a standalone PDB that does not need to be materialized. Note that you cannot create a snapshot copy PDB that is based on a PDB snapshot by including both the `USING SNAPSHOT` clause and the `SNAPSHOT COPY` clause. However, you can create a standalone clone PDB with `USING SNAPSHOT`, and then create a `SNAPSHOT COPY` PDB from the standalone PDB.

 **See Also:**

- ["Materializing a Snapshot Copy PDB"](#)
- ["How PDB Snapshot Carousel Works"](#)

## 7.1.7.2 Storage Requirements for Snapshot Copy PDBs

When you specify the `SNAPSHOT COPY` clause in `CREATE PLUGGABLE DATABASE ... FROM sourcepdb`, all data files of the source PDB must reside in the same storage type.

Storage requirements depend on the setting of the `CLONEDB` initialization parameter:

- `CLONEDB=FALSE`  
The underlying file system for the source PDB files must support storage snapshots. Such file systems include Oracle Automatic Storage Management Cluster File System (Oracle ACFS) and Direct NFS Client storage. Oracle Exadata supports snapshot copy functionality on ASM configured with sparse ASM grid disks.
- `CLONEDB=TRUE`  
The underlying file system for the source PDB files can be any local file system, network file system (NFS), or clustered file system that has Direct NFS enabled and supports sparse files. Most UNIX systems meet these requirements, including Oracle ACFS and ZFS. However, when `CLONEDB=TRUE`, the source PDB must remain in open read-only mode when clones exist.

Direct NFS Client enables an Oracle database to access network attached storage (NAS) devices directly, rather than using the operating system kernel NFS client. If the files of the source PDB are stored on Direct NFS Client storage, then the following additional requirements must be met:

- The source PDB files must be located on an NFS volume.
- Storage credentials must be stored in a Transparent Data Encryption keystore.
- The storage user must have the privileges required to create and destroy snapshots on the volume that hosts the files of the source PDB.
- Credentials must be stored in the keystore using an `ADMINISTER KEY MANAGEMENT ADD SECRET SQL` statement.

The following example configures an Oracle Database secret in a software keystore:

```
ADMINISTER KEY MANAGEMENT
  ADD SECRET 'secret' FOR CLIENT 'client_name'
  USING TAG 'storage_user'
  IDENTIFIED BY keystore_password WITH BACKUP;
```

Run this statement to add a separate entry for each storage server in the configuration. In the previous example, the following values must be specified:

- *secret* is the storage password.



- *client\_name* is the storage server. On a Linux or UNIX platform, it is the name entered in `/etc/hosts` or the IP address of the storage server.
- *tag* is the user name passed to the storage server.
- *keystore\_password* is the password for the keystore.

You cannot unplug PDB clones created using the `SNAPSHOT COPY` clause. You can only drop them. Attempting to unplug a clone created using the `SNAPSHOT COPY` clause results in an error.

Storage clones are named and tagged using the GUID of the target PDB. You can query the `CLONETAG` column of `DBA_PDB_HISTORY` view to view clone tags for storage clones.

 **Note:**

Snapshot copy behavior and efficiency are vendor specific and may vary between vendors.

 **See Also:**

- *Oracle Automatic Storage Management Administrator's Guide* for more information about Oracle ACFS
- *Oracle Grid Infrastructure Installation and Upgrade Guide* for your operating system for information about Direct NFS Client
- *Oracle Database Advanced Security Guide* for more information about Transparent Data Encryption
- My Oracle Support Note 1597027.1 for more information about supported platforms for snapshot cloning of PDBs.
- *Oracle Exadata System Software User's Guide* for information about Exadata support for PDB clones created using the `SNAPSHOT COPY` clause

## 7.1.8 About Split Mirror Clone PDBs

In Oracle ASM, a split mirror is the process of detaching a point-in-time media copy from a parent copy. After the split, updates to the parent do not affect the child copy.

Starting in Oracle Database 18c, the parent copy can be a PDB rather than a storage volume. The split mirror clone PDB resides on the same media as the parent. The principal use case is to rapidly provision test and development PDBs in an Oracle ASM environment.

**Note:**

Oracle ASM flex and extended disk groups are required for split mirror clone PDBs.

Mirror refresh is refreshing a split mirror clone PDB with changes from the parent PDB. In effect, this operation is equivalent to deleting the mirror split, and then taking a new mirror split.

The basic procedure for creating a split mirror clone PDB is as follows:

1. Start SQL\*Plus, and connect to the CDB root.
2. Prepare the PDB to be cloned by issuing the `ALTER PLUGGABLE DATABASE ... PREPARE MIRROR COPY` statement.
3. Create a clone PDB from the parent by issuing the `CREATE PLUGGABLE DATABASE ... USING MIRROR COPY` statement.

To drop a split mirror clone PDB, enter `ALTER PLUGGABLE DATABASE ... DROP MIRROR COPY`.

The `V$ASM_DECLONE_INFO` view shows the relationship between the source PDB, the cloned PDB, and their file groups.

**See Also:**

*Oracle Automatic Storage Management Administrator's Guide*

## 7.2 Cloning a Local PDB: Basic Steps

You can clone a local PDB by executing `CREATE PLUGGABLE DATABASE` and specify the source PDB in the `FROM` clause.

### Prerequisites

You must meet the following prerequisites:

- Complete the prerequisites described in "[General Prerequisites for PDB Creation](#)".
- The current user must have the `CREATE PLUGGABLE DATABASE` system privilege in both the root and the source PDB.
- The source PDB cannot be closed.
- If the CDB is not in local undo mode, then the source PDB must be in open read-only mode. This requirement does not apply if the CDB is in local undo mode.
- If the CDB is not in `ARCHIVELOG` mode, then the source PDB must be in open read-only mode. This requirement does not apply if the CDB is in `ARCHIVELOG` mode.
- If you are creating an application PDB, then the application PDB must have the same character set and national character set as the application container.

If the database character set of the CDB is AL32UTF8, then the character set and national character set of the application container can be different from the CDB. However, all application PDBs in an application container must have same character set and national character set, matching that of the application container.

 **Note:**

You can use the `REFRESH MODE` clause to create a refreshable clone of a local PDB, but only if the database link loops back to the same CDB.

**To clone a local PDB:**

1. In SQL\*Plus, ensure that the current container is the CDB root or an application root.

When the current container is the CDB root, the PDB is created in the CDB. When the current container is an application root, the application PDB is created in the application container.

2. Run the `CREATE PLUGGABLE DATABASE` statement, and specify the source PDB in the `FROM` clause. Specify other clauses when required.

After cloning a local PDB, the source and target PDBs are in the same CDB. The new PDB is in mounted mode, and its status is `NEW`. You can view the open mode of a PDB by querying the `OPEN_MODE` column in the `V$PDBS` view. You can view the status of a PDB by querying the `STATUS` column of the `CDB_PDBS` or `DBA_PDBS` view.

A new default service is created for the PDB. The service has the same name as the PDB and can be used to access the PDB. Oracle Net Services must be configured properly for clients to access this service.

3. Open the new PDB in read/write mode.

You must open the new PDB in read/write mode for Oracle Database to complete the integration of the new PDB into the CDB. An error is returned if you attempt to open the PDB in read-only mode. After the PDB is opened in read/write mode, its status is `NORMAL`.

4. Back up the new PDB.

A PDB cannot be recovered unless it is backed up.

 **Note:**

If an error is returned during PDB creation, then the PDB being created might be in an `UNUSABLE` state. You can check the PDB state by querying the `CDB_PDBS` or `DBA_PDBS` view. You can learn more about PDB creation errors by checking the alert log. An unusable PDB can only be dropped, and it must be dropped before you can create a PDB with the same name as the unusable PDB.

 **See Also:**

- ["About the Current Container" and "About Container Access in a CDB"](#)
- ["About the CDB Undo Mode"](#)
- ["Modifying the Open Mode of One or More PDBs"](#)
- *Oracle Database Backup and Recovery User's Guide* to learn how to back up a PDB

## 7.3 Cloning a Local PDB: Examples

The following examples clone a local source PDB named `pdb1` to a target PDB named `pdb2` given different factors.

In each example, the root to which the new PDB belongs depends on the current container when the `CREATE PLUGGABLE DATABASE` statement is run:

- When the current container is the CDB root, the database creates the PDB in the CDB root.
- When the current container is an application root in an application container, the database creates an application PDB in the application root.

This section contains the following topics:

- [Cloning a Local PDB Using No Clauses: Example](#)  
This example shows the simplest way to clone a PDB.
- [Cloning a Local PDB Using DBCA: Example](#)  
This example clones a PDB using the silent mode of DBCA. Hot cloning is supported.
- [Cloning a Local PDB with the `PATH\_PREFIX` Clause: Example](#)  
This example explains how to clone a local PDB with the `PATH_PREFIX`, `FILE_NAME_CONVERT`, and `SERVICE_NAME_CONVERT` clauses.
- [Cloning a Local PDB Using the `STORAGE` Clause: Example](#)  
This example clones a local PDB using the `FILE_NAME_CONVERT`, `STORAGE`, and `SERVICE_NAME_CONVERT` clauses.
- [Cloning a Local PDB with the `NO DATA` Clause: Example](#)  
This example clones the data model definition of the PDB, but does not clone the data in the PDB.
- [Cloning a PDB from a PDB Snapshot: Scenario](#)  
This scenario creates a new PDB from a PDB snapshot by executing `CREATE PLUGGABLE DATABASE ... USING SNAPSHOT`.
- [Creating a Snapshot Copy PDB: Example](#)  
This example uses the `SNAPSHOT COPY` clause to create a snapshot copy PDB.

### 7.3.1 Cloning a Local PDB Using No Clauses: Example

This example shows the simplest way to clone a PDB.

This example assumes the following factors:

- The `PATH_PREFIX` clause is not required.
- The `FILE_NAME_CONVERT` clause and the `CREATE_FILE_DEST` clause are not required.

Either Oracle Managed Files is enabled, or the `PDB_FILE_NAME_CONVERT` initialization parameter is set. Therefore, the `FILE_NAME_CONVERT` clause is not required. The files will be copied to a new location based on the Oracle Managed Files configuration or the initialization parameter setting.

- Storage limits are not required for the PDB. Therefore, the `STORAGE` clause is not required.
- There is no file with the same name as the new temp file that will be created in the target location. Therefore, the `TEMPFILE REUSE` clause is not required.

The following statement clones the `pdb2` PDB from the `pdb1` PDB:

```
CREATE PLUGGABLE DATABASE pdb2 FROM pdb1;
```

#### See Also:

- *Oracle Database Administrator's Guide* for more information about Oracle Managed Files
- *Oracle Database Reference* for information about the `PDB_FILE_NAME_CONVERT` initialization parameter

## 7.3.2 Cloning a Local PDB Using DBCA: Example

This example clones a PDB using the silent mode of DBCA. Hot cloning is supported.

This example assumes the following factors:

- The source CDB is a single-instance database with the SID `orcl`.
- The source PDB is `pdb1`. You intend for `pdb1` to remain open during the cloning operation, which means that local undo and `ARCHIVELOG` mode are enabled in the CDB. Otherwise, DBCA closes the PDB during the clone operation, and after receiving confirmation, opens the source PDB in read-only mode.
- The new PDB is `pdb2`.
- You are running DBCA in noninteractive mode.

The following command clones the `pdb2` PDB from the `pdb1` PDB:

```
./dbca -silent
-createpluggabledatabase
-sourcedb orcl
-createpdbfrom PDB
-pdbName pdb2
-sourcepdb pdb1
```

 **See Also:**

*Oracle Database Administrator's Guide* for the DBCA command reference

### 7.3.3 Cloning a Local PDB with the PATH\_PREFIX Clause: Example

This example explains how to clone a local PDB with the `PATH_PREFIX`, `FILE_NAME_CONVERT`, and `SERVICE_NAME_CONVERT` clauses.

This example assumes the following factors:

- The path prefix must be added to the PDB's directory object paths. Therefore, the `PATH_PREFIX` clause is required. In this example, the path prefix `/disk2/oracle/pdb2/` is added to the PDB's directory object paths.
- The `FILE_NAME_CONVERT` clause is required to specify the target locations of the copied files. In this example, the files are copied from `/disk1/oracle/pdb1` to `/disk2/oracle/pdb2`.

The `CREATE_FILE_DEST` clause is not used, and neither Oracle Managed Files nor the `PDB_FILE_NAME_CONVERT` initialization parameter is used to specify the target locations of the copied files.

To view the location of the data files for a PDB, run the query in "Example 19-7".

- Storage limits are not required for the PDB. Therefore, the `STORAGE` clause is not required.
- There is no file with the same name as the new temp file that will be created in the target location. Therefore, the `TEMPFILE REUSE` clause is not required.
- The PDB that is being cloned (`pdb1`) has two user-defined services: `salesrep_ca` and `orders_ca` for the sales representatives and order entry personnel in California. The new services will be for the sales representatives and order entry personnel in Oregon, and the service names will be renamed to `salesrep_or` and `orders_or`, respectively, in the cloned PDB (`pdb2`).
- Future tablespaces created within the PDB will be created with the `NOLOGGING` attribute by default. This feature is available starting with Oracle Database 12c Release 1 (12.1.0.2).

The following statement clones the `pdb2` PDB from the `pdb1` PDB:

```
CREATE PLUGGABLE DATABASE pdb2 FROM pdb1
  PATH_PREFIX = '/disk2/oracle/pdb2/'
  FILE_NAME_CONVERT = ('/disk1/oracle/pdb1/', '/disk2/oracle/pdb2/')
  SERVICE_NAME_CONVERT =
('salesrep_ca', 'salesrep_or', 'orders_ca', 'orders_or')
  NOLOGGING;
```

## 7.3.4 Cloning a Local PDB Using the STORAGE Clause: Example

This example clones a local PDB using the `FILE_NAME_CONVERT`, `STORAGE`, and `SERVICE_NAME_CONVERT` clauses.

This example assumes the following factors:

- The `PATH_PREFIX` clause is not required.
- The `FILE_NAME_CONVERT` clause is required to specify the target locations of the copied files. In this example, the files are copied from `/disk1/oracle/pdb1` to `/disk2/oracle/pdb2`.

The `CREATE_FILE_DEST` clause is not used, and neither Oracle Managed Files nor the `PDB_FILE_NAME_CONVERT` initialization parameter is used to specify the target locations of the copied files.

To view the location of the data files for a PDB, run the query in [Example 19-7](#).

- Storage limits must be enforced for the PDB. Therefore, the `STORAGE` clause is required. Specifically, all tablespaces that belong to the PDB must not exceed 2 gigabytes.
- The source PDB (`pdb1`) has two user-defined services: `salesrep_ca` and `orders_ca` for the sales representatives and order entry personnel in California. The new services will be for the sales representatives and order entry personnel in Oregon, and the service names will be renamed to `salesrep_or` and `orders_or`, respectively, in the cloned PDB (`pdb2`).
- There is no file with the same name as the new temp file that will be created in the target location. Therefore, the `TEMPFILE REUSE` clause is not required.

The following statement clones the `pdb2` PDB from the `pdb1` PDB:

```
CREATE PLUGGABLE DATABASE pdb2 FROM pdb1
  FILE_NAME_CONVERT = ('/disk1/oracle/pdb1/', '/disk2/oracle/pdb2/')
  STORAGE (MAXSIZE 2G)
  SERVICE_NAME_CONVERT =
('salesrep_ca','salesrep_or','orders_ca','orders_or');
```

## 7.3.5 Cloning a Local PDB with the NO DATA Clause: Example

This example clones the data model definition of the PDB, but does not clone the data in the PDB.

This example assumes the following factors:

- The `NO DATA` clause is required because the goal is to clone the data model definition of the source PDB without cloning its data.
- The `PATH_PREFIX` clause is not required.
- The `FILE_NAME_CONVERT` clause and the `CREATE_FILE_DEST` clause are not required.

Either Oracle Managed Files is enabled, or the `PDB_FILE_NAME_CONVERT` initialization parameter is set. Therefore, the `FILE_NAME_CONVERT` clause is not

required. The process copies the files to a new location based on the Oracle Managed Files configuration or the initialization parameter setting.

- Storage limits are not required for the PDB. Therefore, the `STORAGE` clause is not required.
- There is no file with the same name as the new temp file that will be created in the target location. Therefore, the `TEMPFILE REUSE` clause is not required.

Assume that the source PDB `pdb1` has a large amount of data. The following steps illustrate how the clone does not contain the data of the source PDB when the operation is complete:

1. With the source PDB `pdb1` as the current container, query a table with a large amount of data:

```
SELECT COUNT(*) FROM tpch.lineitem;

COUNT(*)
-----
60001215
```

The table has over sixty million rows.

2. Clone the source PDB with the `NO DATA` clause:

```
CREATE PLUGGABLE DATABASE pdb2 FROM pdb1 NO DATA;
```

3. Open the cloned PDB:

```
ALTER PLUGGABLE DATABASE pdb2 OPEN;
```

4. With the cloned PDB `pdb2` as the current container, query the table that has a large amount of data in the source PDB:

```
SELECT COUNT(*) FROM tpch.lineitem;

COUNT(*)
-----
0
```

The table in the cloned PDB has no rows.

## 7.3.6 Cloning a PDB from a PDB Snapshot: Scenario

This scenario creates a new PDB from a PDB snapshot by executing `CREATE PLUGGABLE DATABASE ... USING SNAPSHOT`.

### Assumptions

This example assumes the following factors:

- A PDB snapshot carousel exists with 8 daily snapshots, named after the weekday, day of the month, and time when they were created: `pdb1_mon_2_1201`, `pdb1_tue_3_1201`, `pdb1_wed_4_1201`, and so on.



- The new PDB will be a clone of a snapshot named `pdb1_wed_4_1201`, which is a snapshot of `pdb1` taken last Wednesday on the 4th of the month at 12:01 a.m.
- The `PATH_PREFIX` clause is not required.
- The `FILE_NAME_CONVERT` clause and the `CREATE_FILE_DEST` clause are not required.

Either Oracle Managed Files is enabled, or the `PDB_FILE_NAME_CONVERT` initialization parameter is set. Therefore, the `FILE_NAME_CONVERT` clause is not required. The files will be copied to a new location based on the Oracle Managed Files configuration or the initialization parameter setting.

- Storage limits are not required for the PDB. Therefore, the `STORAGE` clause is not required.
- There is no file with the same name as the new temp file that will be created in the target location. Therefore, the `TEMPFILE REUSE` clause is not required.

#### To clone a PDB from a PDB snapshot:

1. In SQL\*Plus, ensure that the current container is the CDB root or an application root.

When the current container is the CDB root, the PDB is created in the CDB. When the current container is an application root, the application PDB is created in the application container.

2. Execute the `CREATE PLUGGABLE DATABASE` statement.

The following statement clones the `pdb1_copy` PDB from the PDB snapshot named `pdb1_wed_4_1201`:

```
CREATE PLUGGABLE DATABASE pdb1_copy FROM pdb1 USING SNAPSHOT
pdb1_wed_4_1201;
```



#### See Also:

["Configuring Automatic PDB Snapshots"](#)

## 7.3.7 Creating a Snapshot Copy PDB: Example

This example uses the `SNAPSHOT COPY` clause to create a snapshot copy PDB.

This example assumes the following factors:

- The new snapshot copy PDB will be created based on a PDB snapshot named `pdb1_snap3`, which is a PDB snapshot that is a copy of `pdb1` at a specific point in time and SCN.
- The `PATH_PREFIX` clause is not required.
- The `FILE_NAME_CONVERT` clause and the `CREATE_FILE_DEST` clause are not required.

Either Oracle Managed Files is enabled, or the `PDB_FILE_NAME_CONVERT` initialization parameter is set. Therefore, the `FILE_NAME_CONVERT` clause is not

required. The files will be copied to a new location based on the Oracle Managed Files configuration or the initialization parameter setting.

- Storage limits are not required for the PDB. Therefore, the `STORAGE` clause is not required.
- There is no file with the same name as the new temp file that will be created in the target location. Therefore, the `TEMPFILE REUSE` clause is not required.

Given the preceding factors, the following statement clones the `pdb1_snap_copy` PDB from the `pdb1_snap3` PDB snapshot:

```
CREATE PLUGGABLE DATABASE pdb1_snap_copy FROM pdb1 USING SNAPSHOT
pdb1_snap3 SNAPSHOT COPY;
```

After `pdb1_snap_copy` is created, it is dependent on the `pdb1_snap3` PDB snapshot. Therefore, you cannot drop `pdb1_snap3` when `pdb1_snap_copy` exists. However, you can transform `pd1_snap_copy` from a snapshot copy PDB into a regular PDB by running an `ALTER PLUGGABLE DATABASE ... MATERIALIZE` statement. Materializing the PDB means that `pdb1_snap_copy` no longer depends on `pdb1_snap3`, enabling you to drop `pdb1_snap3`.



#### See Also:

["Materializing a Snapshot Copy PDB"](#)

## 7.4 Cloning a Remote PDB: Basic Steps

You can create a PDB by cloning a remote PDB. After the cloning operation, the source and the target PDB are in different locations.

### General Prerequisites

The following prerequisites must be met:

- Complete the prerequisites described in ["General Prerequisites for PDB Creation"](#).
- The current user must have the `CREATE PLUGGABLE DATABASE` system privilege in the root of the CDB that will contain the target PDB.
- The source and target platforms must meet the following requirements:
  - They must have the same endianness.
  - The database options installed on the source platform must be the same as, or a subset of, the database options installed on the target platform.
- If you are creating an application PDB, then the application name and version of the source PDB must match the application name and version of the target application container.

### Prerequisites for Character Sets

- If the character set of the CDB to which the PDB is being cloned is not `AL32UTF8`, then the source and target must have compatible character sets and national

character sets. If the character set of the CDB to which the PDB is being cloned is AL32UTF8, then this requirement does not apply.

- If you are creating an application PDB, then the application PDB must have the same character set and national character set as the application container.

If the database character set of the CDB is AL32UTF8, then the character set and national character set of the application container can differ from the CDB. However, all application PDBs in an application container must have the same character set and national character set, matching that of the application container.

### Prerequisites for the Open Mode of the Source PDB

- The source PDB must not be closed.
- If the remote CDB is not in local undo mode, then the source PDB must be open in read-only mode.  
See "[About the CDB Undo Mode](#)".
- If the remote CDB is not in ARCHIVELOG mode, then the source PDB must be open in read-only mode.
- If you are creating a refreshable PDB, then the source PDB must be in ARCHIVELOG mode and local undo mode.

### Prerequisites for the Database Link

The following prerequisites must be met:

- A database link must enable a connection from the CDB to which the PDB is being cloned to the source PDB's CDB. The database link can connect to either the root of the CDB, to an application PDB if the source is an application PDB, or to the PDB.
- The user that the database link connects with must have the `CREATE PLUGGABLE DATABASE` system privilege.
- If the database link connects to the root in the CDB of the source PDB, then the user that the database link connects with must be a common user.
- In an Oracle Data Guard environment, if you are performing a remote clone of a PDB into a primary CDB, then on the standby CDB set the `STANDBY_PDB_SOURCE_FILE_DBLINK` initialization parameter. This parameter specifies the name of the database link used in `CREATE PLUGGABLE DATABASE ... FROM dblink`. The standby CDB attempts to copy the data files from the source PDB referenced in the database link, but only if the source PDB is open in read-only mode. Otherwise, you must copy data files to the Oracle Managed Files location on the standby CDB.

### To clone a remote PDB:

1. In SQL\*Plus, ensure that the current container is the root of the target CDB or the application root of the target application container.
2. Run the `CREATE PLUGGABLE DATABASE` statement, and specify the source PDB in the `FROM` clause. Specify other clauses when required.

After you create the PDB, it is in mounted mode, and its status is `NEW`. You can view the open mode of a PDB by querying the `OPEN_MODE` column in the `V$PDBS`

view. You can view the status of a PDB by querying the `STATUS` column of the `CDB_PDBS` or `DBA_PDBS` view.

A new default service is created for the PDB. The service has the same name as the PDB and can be used to access the PDB. Oracle Net Services must be configured properly for clients to access this service.

 **Note:**

If an error is returned during PDB creation, then the PDB being created might be in an `UNUSABLE` state. You can check the PDB state by querying the `CDB_PDBS` or `DBA_PDBS` view, and you can learn more about PDB creation errors by checking the alert log. An unusable PDB can only be dropped, and it must be dropped before a PDB with the same name as the unusable PDB can be created.

3. Open the new PDB in read/write mode.

You must open the new PDB in read/write mode for Oracle Database to complete the integration of the new PDB into the CDB. An error is returned if you attempt to open the PDB in read-only mode. After the PDB is opened in read/write mode, its status is `NORMAL`.

4. Back up the PDB.

A PDB cannot be recovered unless it is backed up.

 **See Also:**

- ["Refreshing a PDB"](#)
- ["Modifying the Open Mode of One or More PDBs"](#)
- *Oracle Database Backup and Recovery User's Guide* for information about backing up a PDB
- *Oracle Data Guard Concepts and Administration* to learn more about plugging in a PDB in an Oracle Data Guard environment
- *Oracle Database Globalization Support Guide* to learn about the requirements for the compatibility of character sets
- *Oracle Database Reference* for information about the `PDB_FILE_NAME_CONVERT` initialization parameter

## 7.5 Cloning a Remote PDB or Non-CDB: Examples

These examples clone a remote PDB or non-CDB given different factors.

In each example, the root to which the new PDB belongs depends on the current container when the `CREATE PLUGGABLE DATABASE` statement is run:

- When the current container is the CDB root, the new PDB is created in the CDB root.

- When the current container is an application root in an application container, the new PDB is created as an application PDB in the application root.

This section contains the following topics:

- [Cloning a Remote PDB Using No Clauses: Example](#)  
This example clones a remote source PDB named `pdb1` to a target PDB named `pdb2` given different factors.
- [Cloning a Remote Non-CDB: Example](#)  
This example creates a new PDB by cloning a remote source non-CDB named `mydb` to a target PDB named `pdb2` given different factors.
- [Creating a Refreshable Clone: Example](#)  
This example clones the remote `pdb1` to the target `pdb2` given different factors.

## 7.5.1 Cloning a Remote PDB Using No Clauses: Example

This example clones a remote source PDB named `pdb1` to a target PDB named `pdb2` given different factors.

This example assumes the following factors:

- The database link name to the remote PDB is `pdb1_link`.
- The `PATH_PREFIX` clause is not required.
- The `FILE_NAME_CONVERT` clause and the `CREATE_FILE_DEST` clause are not required.

Either Oracle Managed Files is enabled, or the `PDB_FILE_NAME_CONVERT` initialization parameter is set. The files will be copied to a new location based on the Oracle Managed Files configuration or the initialization parameter setting.

- Storage limits are not required for the PDB. Therefore, the `STORAGE` clause is not required.
- There is no file with the same name as the new temp file that will be created in the target location. Therefore, the `TEMPFILE REUSE` clause is not required.

The following statement clones the `pdb2` PDB from the `pdb1` remote PDB:

```
CREATE PLUGGABLE DATABASE pdb2 FROM pdb1@pdb1_link;
```

### See Also:

- *Oracle Database Administrator's Guide* for more information about Oracle Managed Files
- *Oracle Database Reference* for information about the `PDB_FILE_NAME_CONVERT` initialization parameter

## 7.5.2 Cloning a Remote Non-CDB: Example

This example creates a new PDB by cloning a remote source non-CDB named `mydb` to a target PDB named `pdb2` given different factors.

This example assumes the following factors:

- The database link name to the remote non-CDB is `mydb_link`.
- The `PATH_PREFIX` clause is not required.
- The `FILE_NAME_CONVERT` clause and the `CREATE_FILE_DEST` clause are not required.

Either Oracle Managed Files is enabled, or the `PDB_FILE_NAME_CONVERT` initialization parameter is set. The files will be copied to a new location based on the Oracle Managed Files configuration or the initialization parameter setting.

- Storage limits are not required for the PDB. Therefore, the `STORAGE` clause is not required.
- There is no file with the same name as the new temp file that will be created in the target location. Therefore, the `TEMPFILE REUSE` clause is not required.

The following statement creates the `pdb2` PDB from the remote non-CDB named `mydb`:

```
CREATE PLUGGABLE DATABASE pdb2 FROM mydb@mydb_link;
```

When the source database is a non-CDB, you can substitute `NON$CDB` for the name of the non-CDB. For example, the following statement is equivalent to the previous example:

```
CREATE PLUGGABLE DATABASE pdb2 FROM NON$CDB@mydb_link;
```



### See Also:

*Oracle Database Administrator's Guide* for more information about Oracle Managed Files

## 7.5.3 Creating a Refreshable Clone: Example

This example clones the remote `pdb1` to the target `pdb2` given different factors.

The clone is a refreshable copy of the source PDB. You can refresh the cloned PDB to update it with any changes made to the source PDB. This example assumes the following factors:

- The database link name to the remote PDB is `pdb1_link`.
- The `PATH_PREFIX` clause is not required.
- The `FILE_NAME_CONVERT` clause and the `CREATE_FILE_DEST` clause are not required.

Either Oracle Managed Files is enabled, or the `PDB_FILE_NAME_CONVERT` initialization parameter is set. The files will be copied to a new location based on the Oracle Managed Files configuration or the initialization parameter setting.

- Storage limits are not required for the PDB. Therefore, the `STORAGE` clause is not required.
- There is no file with the same name as the new temp file that will be created in the target location. Therefore, the `TEMPFILE REUSE` clause is not required.
- The refreshable clone will be refreshed automatically every 60 minutes.

 **Note:**

To create a refreshable PDB, the source PDB must be in `ARCHIVELOG` mode and local undo mode.

The following statement clones the `pdb2` PDB from the `pdb1` remote PDB:

```
CREATE PLUGGABLE DATABASE pdb2 FROM pdb1@pdb1_link REFRESH MODE EVERY 60
MINUTES;
```

 **See Also:**

- ["Managing Refreshable Clone PDBs"](#)
- *Oracle Database Administrator's Guide* for more information about Oracle Managed Files

## 7.6 After Cloning a PDB

Certain rules regarding users and tablespaces apply after cloning a PDB.

The following applies after cloning a PDB:

- Users in the PDB who used the default temporary tablespace of the source non-CDB or PDB use the default temporary tablespace of the cloned PDB. Users who used nondefault temporary tablespaces in the non-CDB or PDB continue to use the same local temporary tablespaces in the cloned PDB.
- When cloning a remote PDB, user-created common user accounts that existed in the source CDB but not in the target CDB do not have privileges granted commonly. However, if the target CDB has a common user with the same name as a common user in the PDB, then the latter is linked to the former and has the privileges granted to this common user in the target CDB.

If the cloned or plugged-in PDB has a common user account that does not exist in the target CDB, and if this user does not own objects in the PDB, then Oracle Database drops the user during the synchronization step; otherwise, the user

account is locked in the target PDB. You have the following options regarding locked accounts:

- Close the PDB, connect to the root, and create a common user account with the same name. When the PDB is opened in read/write mode, differences in roles and privileges granted commonly to the user account are resolved, and you can unlock the account. Privileges and roles granted locally to the user account remain unchanged during this process.
- Create a new local user account in the PDB and use Data Pump to export/import the locked user's data into the new local user's schema.
- Leave the user account locked.
- Drop the user account.

#### See Also:

- ["About Managing Tablespaces in a CDB"](#)
- ["Managing Services for PDBs"](#)
- ["Example 19-9"](#)
- *Oracle Database Concepts* for information about common users and local users
- *Oracle Database Security Guide* for information about creating a local user
- *Oracle Database Utilities* for information about using Oracle Data Pump with a CDB

## 7.7 Materializing a Snapshot Copy PDB

You can materialize a snapshot copy PDB by running an `ALTER PLUGGABLE DATABASE` statement with the `MATERIALIZED` clause. Materializing a snapshot copy PDB copies all data blocks.

When you create a snapshot copy PDB, it is dependent on the source PDB. Because of this dependency, you cannot drop the source PDB.

Materializing the snapshot copy PDB transforms the snapshot copy PDB, which uses sparse files, into a full PDB, which does *not* use sparse files. Therefore, it is no longer dependent on the source PDB, which can be dropped.



 **Note:**

A PDB snapshot created with the `USING SNAPSHOT` clause and a snapshot copy PDB created with the `SNAPSHOT COPY` clause are two distinct types of snapshots and should not be confused with each other. The `USING SNAPSHOT` clause creates a full PDB that does not need to be materialized. The `SNAPSHOT COPY` clause creates a sparse PDB that must be materialized if you want to drop the PDB snapshot on which it is based.

**To materialize a PDB snapshot:**

1. In SQL\*Plus, ensure that the current container is the snapshot copy PDB that is being materialized.
2. Run an `ALTER PLUGGABLE DATABASE` statement with the `MATERIALIZED` clause.

**Example 7-2 Materializing a Snapshot Copy PDB**

The following SQL statement materializes a snapshot copy PDB:

```
ALTER PLUGGABLE DATABASE MATERIALIZED;
```

 **See Also:**

- ["About Snapshot Copy PDBs"](#) for more information about snapshot copy PDBs
- ["Creating a Snapshot Copy PDB: Example"](#)

# 8

## Relocating a PDB

You can move a PDB to a different CDB or application container.

This chapter contains the following topics:

- [About PDB Relocation](#)  
During relocation, the source PDB can be open in read/write mode and fully functional.
- [Purpose of PDB Relocation](#)  
This technique is the fastest way to move a PDB with minimal or no down time. Otherwise, unplugging the source PDB requires a PDB outage until the PDB is plugged in to the target CDB.
- [How PDB Relocation Works](#)  
The operation moves the files associated with the PDB to a new location, adds the PDB to the target CDB, and then opens the PDB.
- [Creating a PDB by Relocating It](#)  
The `CREATE PLUGGABLE DATABASE ... RELOCATE` statement moves a PDB to a different container.

### 8.1 About PDB Relocation

During relocation, the source PDB can be open in read/write mode and fully functional.

When you open the relocated PDB for the first time, Oracle Database drains active sessions on the source PDB and redirects client connections to the relocated PDB services. Opening the relocated PDB initiates the shutdown of the original source PDB. The source and relocated PDBs are never open at the same time.

The following graphic shows the relocation of a common PDB (that is, not an application PDB) to a new CDB. The source PDB is plugged in to the CDB root, and the target PDB is plugged in to the CDB root. Note that the `CREATE PLUGGABLE DATABASE ... RELOCATE` statement copies the data blocks, undo blocks, and redo blocks to the new location. A database link is required.

Figure 8-1 Relocate a PDB into the Root Container

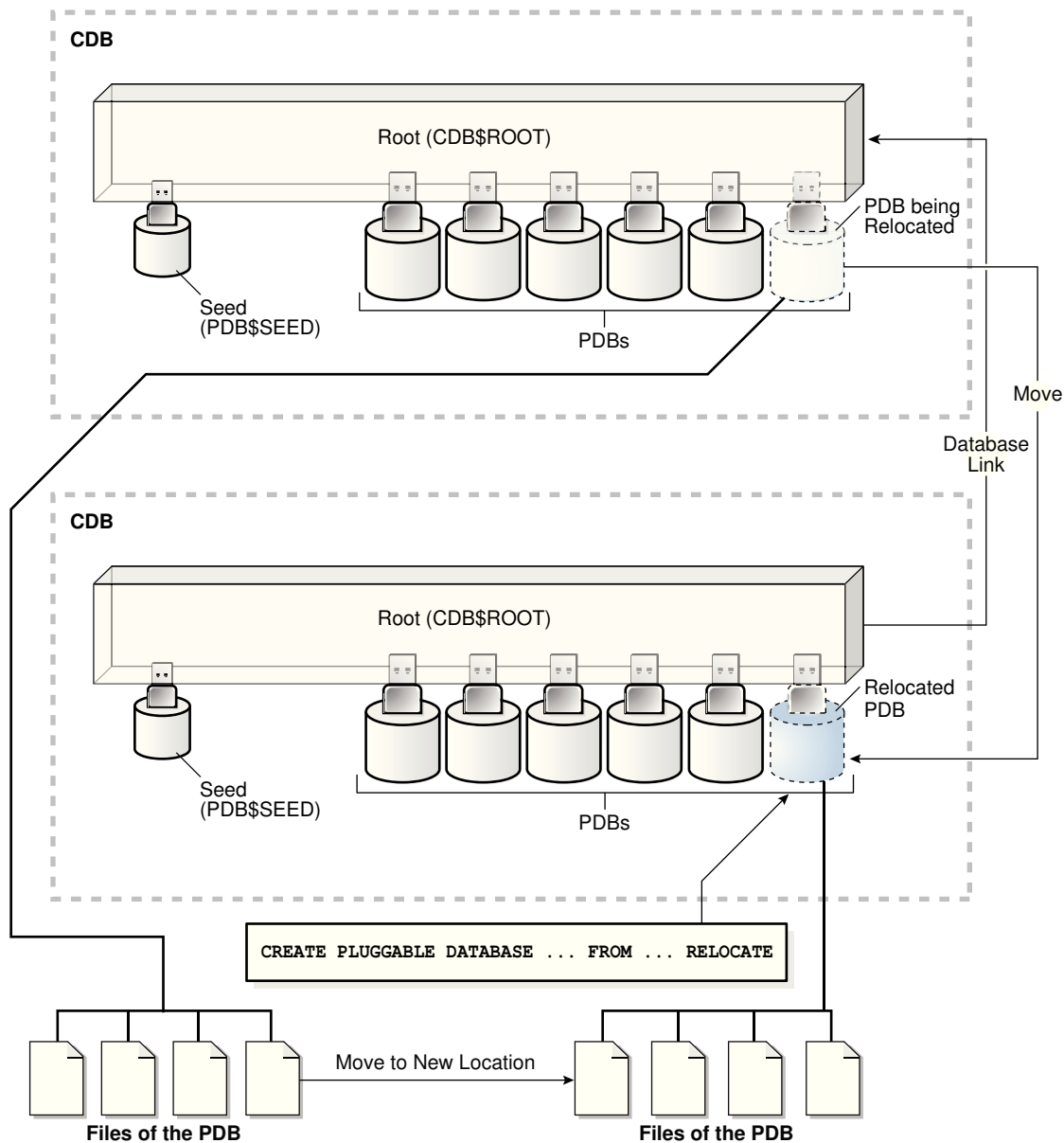

When the target PDB is an application PDB or application root, you have the following options:

- You can relocate a PDB into an application container as an application PDB. The target PDB can be in the same CDB or a different CDB.
- You can relocate an application PDB from one application root to another. The target PDB can be in the same CDB or a different CDB.
- You can relocate an empty application root from one CDB to another, but the application root must not have any hosted application PDBs.

The following graphic illustrates how this technique creates a new application PDB in an application container.

Figure 8-2 Relocate a PDB into an Application Container

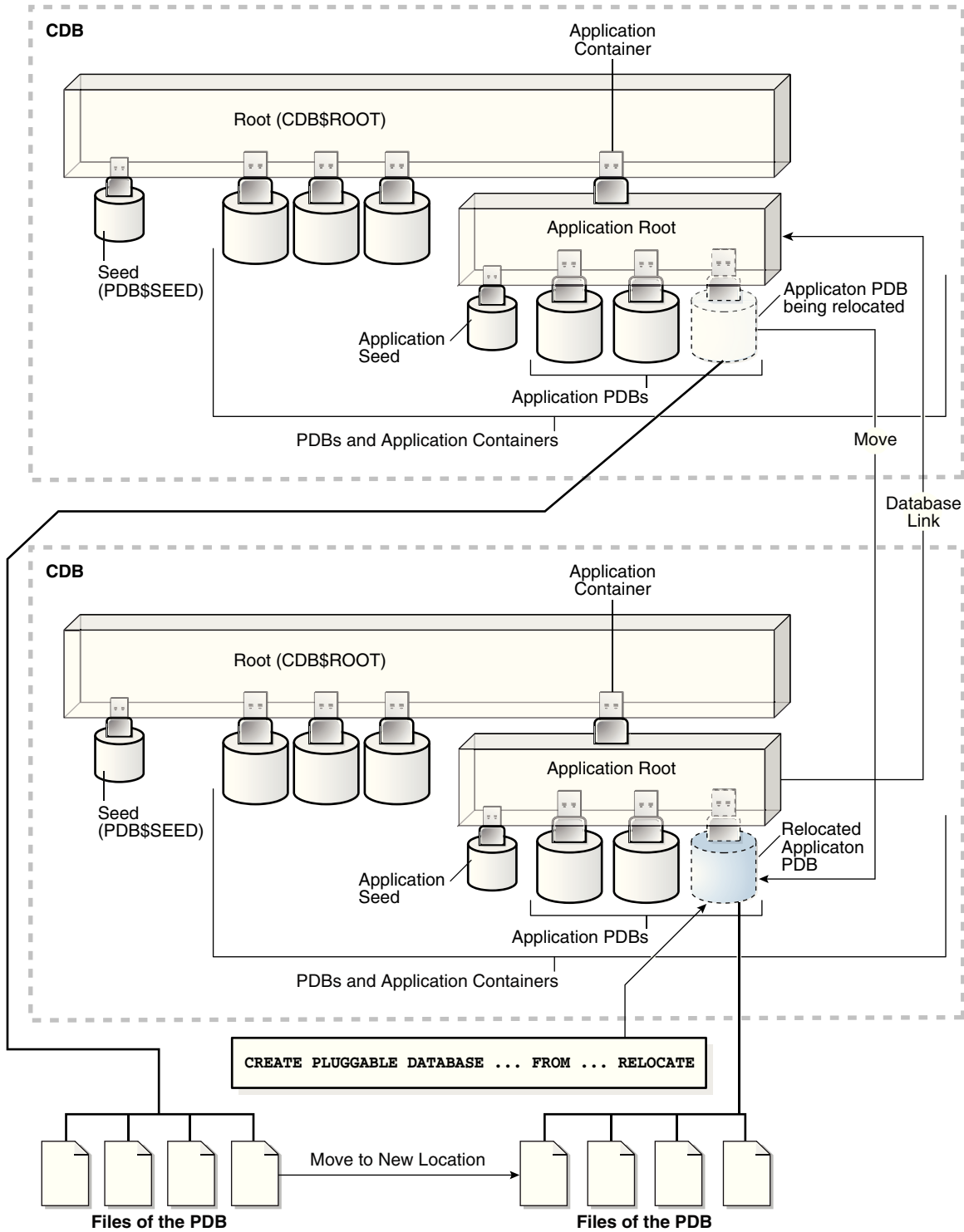

 **See Also:**  
"PDB Storage"

## 8.2 Purpose of PDB Relocation

This technique is the fastest way to move a PDB with minimal or no down time. Otherwise, unplugging the source PDB requires a PDB outage until the PDB is plugged in to the target CDB.

When moving a PDB between data centers, or from an on-premises environment to a cloud environment, all the data must physically move. For large PDBs, this process may take considerable time, possibly violating availability components of an SLA. PDB relocation eliminates the outage completely. You can relocate the PDB without taking the application offline, changing the application, or changing network connection strings.

## 8.3 How PDB Relocation Works

The operation moves the files associated with the PDB to a new location, adds the PDB to the target CDB, and then opens the PDB.

PDB relocation executes an online block level copy of the source PDB data files, redo, and undo while the source PDB is open with active sessions. When the target PDB comes online because of an `ALTER PLUGGABLE DATABASE OPEN` statement, Oracle Database terminates the active sessions and closes the source PDB.

Oracle Database 18c introduces database-generic session draining, where active sessions can exit gracefully under a timer. After the timer has expired, Oracle Database terminates all active sessions and reconnects them to the relocated PDB. This feature is enabled by default for all maintenance operations invoked at the database service and PDB levels: `stop service`, `relocate service`, `relocate PDB`, and `stop PDB`.

PDB relocation services are available in Oracle RAC and single-instance environments in which a PDB relocates between CDB instances in the same clustered database or between distinct CDBs. An example of finer-grained relocation in an Oracle RAC environment is service relocation between PDB instances. Oracle RAC and Oracle Clusterware offer a rich high availability environment that further minimizes the effect on connected clients during relocation. For example, shared storage may minimize or remove the necessity to copy data files.

This section contains the following topics:

 **Note:**

In an Oracle Clusterware environment, when relocating a PDB between different CDBs, you must create the non-default service resource using `SRVCTL`.

- [Server Session Draining When Relocating or Stopping PDBs](#)  
A key requirement of planned maintenance is draining or failing over PDB sessions so that application work is not interrupted.
- [Stages of PDB Relocation](#)  
The details of PDB relocation vary depending on the listener networks.

 **See Also:**

*Oracle Clusterware Administration and Deployment Guide* for the SRVCTL reference

### 8.3.1 Server Session Draining When Relocating or Stopping PDBs

A key requirement of planned maintenance is draining or failing over PDB sessions so that application work is not interrupted.

Beginning with Oracle Database 18c, the database automatically marks sessions for draining when a PDB is relocated or stopped. The database uses an extensible set of rules to determine when to drain a database session, which persists until a rule is satisfied. The rules include the following:

- Standard application server tests for validity
- Custom SQL tests for validity
- Request boundaries are in use and no request is active
- Request boundaries are in use and the current request has ended
- The session has one or more session states that are recoverable, and can be recreated at failover

A typical use case is application servers and pooled applications that test connections when borrowing from connection pools, returning connections to the pool, and at batch commits. When draining sessions, the database automatically intercepts the connection test, closes the connection, and then returns a failed status for the test. After receiving the failed status, the application layer can request a different connection. In this way, the application is not disrupted.

For an optimal configuration that minimizes the effect on the client, consider using Oracle RAC with FAN and Application Continuity.

 **See Also:**

*Oracle Real Application Clusters Administration and Deployment Guide* to learn more about draining database sessions for planned maintenance

### 8.3.2 Stages of PDB Relocation

The details of PDB relocation vary depending on the listener networks.

This section contains the following topics:

- [PDB Relocation in a Common Listener Network](#)  
When the source and target location share a common listener network, forwarding client connections is not necessary because the SQL\*Net layer forwards client connections implicitly.
- [PDB Relocation in Isolated Listener Networks](#)  
When independent listeners do not use cross-registration, the listener in the target CDB and source CDB have no knowledge of each other or of their respective published services.

### 8.3.2.1 PDB Relocation in a Common Listener Network

When the source and target location share a common listener network, forwarding client connections is not necessary because the SQL\*Net layer forwards client connections implicitly.

#### AVAILABILITY NORMAL

When the listener network is common, specify the `AVAILABILITY NORMAL` clause in `CREATE PLUGGABLE DATABASE ... RELOCATE`. This option is the default. The following situations are typical use cases for `AVAILABILITY NORMAL`:

- **Shared listener**  
If you use the same listener for the PDB in its old and new locations, then new connections are automatically routed to the new location when relocation completes. This situation is typical of a relocation between CDBs in the same host. In this case, the PDB is re-registered with the listener in its new location. Additional connection handling is not required.
- **Cross-registered listeners**  
If the PDBs use different listeners, and if you employ cross-registration of their respective listeners through configuration of the `local_listener` and `remote_listener` parameters, then relocation is seamless. The availability and location of the PDB's services are automatically registered with both listeners. This situation is typical of relocation between hosts within a data center, perhaps for load balancing purposes.

In shared and cross registered listener environments, services from all databases are published to the common listener network. For this reason, services for relocated PDBs are immediately known to the common listener network. To avoid service name space collisions, PDB service definitions must be unique in the common listener network.

#### Stages of Relocation in a Common Listener Network

1. The user issues `CREATE PLUGGABLE DATABASE ... RELOCATE AVAILABILITY NORMAL`.

This step executes a hot clone of the source PDB from its original location to its target location. The source PDB copies data files, undo blocks, and redo blocks to the target PDB as of an implicit begin SCN marker.

When this step completes, two transactionally consistent copies of this PDB exist: one in the source container and one in the target container. For the duration of the operation, processing continues uninterrupted on the source PDB. Users of an

application or applications connected to the source PDB are unaware that a relocation is underway.

All existing application connections, and new connections created during this step, continue to connect to the source PDB.

2. The user issues `ALTER PLUGGABLE DATABASE OPEN`.

The following actions occur in the background:

- a. The target PDB implicitly sets the end SCN marker, and applies any redo or undo required to complete media recovery to satisfy the implicit end SCN marker.
- b. When media recovery occurs on the target PDB, Oracle Database initiates active session draining on the source PDB.
- c. PDB services are registered with the listener and are available on the target CDB.
- d. The source PDB is closed.
- e. The target PDB opens in read/write mode.

This step completes the relocation of the PDB to the target CDB. At the end of the operation, connections point to the newly relocated PDB.

After the PDB is opened in read/write mode, its status is `NORMAL`. The database returns an error if you attempt to open the PDB in read-only mode.

 **See Also:**

- *Oracle Database Net Services Administrator's Guide* for more information about listener redirects
- *Oracle Real Application Clusters Administration and Deployment Guide* to learn more about using Application Continuity to drain and migration sessions before planned maintenance

### 8.3.2.2 PDB Relocation in Isolated Listener Networks

When independent listeners do not use cross-registration, the listener in the target CDB and source CDB have no knowledge of each other or of their respective published services.

#### AVAILABILITY MAX

The `AVAILABILITY MAX` clause in `CREATE PLUGGABLE DATABASE ... RELOCATE` implicitly instructs the SQL\*Net layer to reconfigure the original listener. This situation may be common when relocating a PDB between data centers. This configuration is intended to be temporary while the Oracle Internet Directory (OID) or LDAP server is updated or the client connections are modified.

If a local listener redirects to a Single Client Access Name (SCAN) listener in an Oracle RAC configuration, then this listener may need to further redirect the client connection request to another cluster node. Multiple redirects are not supported by Oracle Net listeners by default. Because any SCAN listener can route the connection



request to any node, set the `ALLOW_MULTIPLE_REDIRECTS_listener_name` parameter to the `listener_name` of every SCAN listener, and set it in every `listener.ora` file in the cluster. For example, if the SCAN listeners are named `listener_scan1`, `listener_scan2`, and `listener_scan3`, then the `listener.ora` file on every destination host should have the following settings:

```
ALLOW_MULTIPLE_REDIRECTS_LISTENER_SCAN1=YES  
ALLOW_MULTIPLE_REDIRECTS_LISTENER_SCAN2=YES  
ALLOW_MULTIPLE_REDIRECTS_LISTENER_SCAN3=YES
```

**▲ Caution:**

Do not set the `ALLOW_MULTIPLE_REDIRECTS_listener_name` parameter for node listeners because it may allow infinite redirection loops in certain network configurations.

### Stages of Relocation in an Isolated Listener Network

1. The user issues `CREATE PLUGGABLE DATABASE ... RELOCATE AVAILABILITY MAX`.

This step executes a hot clone of the source PDB from its original location to its target location. The source PDB copies data files, undo blocks, and redo blocks to the target PDB as of an implicit begin SCN marker.

2. The user issues `ALTER PLUGGABLE DATABASE OPEN`.

The following actions occur in the background:

- a. The target PDB implicitly sets the end SCN marker, and applies any redo or undo required to complete media recovery to satisfy the implicit end SCN marker.
- b. When media recovery occurs on the target PDB, Oracle Database initiates active session draining on the source PDB.
- c. The `LISTENER_NETWORKS` initialization parameter is implicitly updated in the source PDB with the forwarding address, and the listener PDB services for the source CDB are updated with the forwarding address.
- d. The target PDB opens in read-only mode while media recovery completes.  
At this stage, only queries of the target PDB are permitted. Queries behave exactly as if they had been run on the source PDB. However, connections attempting DML do not complete.
- e. Read-only connections are immediately forwarded to the new hosting listener, and new read/write connections are forwarded to the new hosting listener, where they spin until the target PDB is opened in a consistent state.
- f. The source PDB executes a `SHUTDOWN IMMEDIATE`, terminating persistent connections.
- g. The target PDB opens in read/write mode.

This step completes the relocation of the PDB to the target CDB. At the end of the operation, connections point to the newly relocated PDB.

After the PDB is opened in read/write mode, its status is `NORMAL`. The database returns an error if you attempt to open the PDB in read-only mode.

 **Note:**

An artifact known as a *tombstone PDB* remains in the source CDB to protect the PDB's namespace and preserve the listener forwarding configuration until the updates are complete. In the root of the source CDB, the tombstone PDB is visible in `V$CONTAINERS` with a status of `RELOCATED`. When you change the application connect strings to provide direct connections to the target PDB, you can drop the tombstone PDB from the source CDB.

 **See Also:**

- ["Creating an Application PDB"](#)
- *Oracle Database Net Services Administrator's Guide* for more information about listener redirects
- *Oracle Real Application Clusters Administration and Deployment Guide* to learn more about using Application Continuity to drain and migration sessions before planned maintenance

## 8.4 Creating a PDB by Relocating It

The `CREATE PLUGGABLE DATABASE ... RELOCATE` statement moves a PDB to a different container.

The *target CDB* is the CDB to which the PDB is being relocated. The *target PDB* is the relocated PDB. After the `CREATE PLUGGABLE DATABASE ... RELOCATE` operation completes, Oracle Database moves the PDB from the source CDB and then adds it to the target CDB.

### General Prerequisites

Address the questions that apply to relocating a PDB in "[Table 5-3](#)". The table describes which `CREATE PLUGGABLE DATABASE` clauses you must specify based on different factors. Also, complete the prerequisites described in "[General Prerequisites for PDB Creation](#)".

### Specific Prerequisites

Before relocating the PDB, you must meet the following prerequisites:

- The source CDB must be in local undo mode.

- In the source CDB, you must save the service and open state of the PDBs in all database instances. Log in to the CDB root as an administrator and issue the following statement:

```
ALTER PLUGGABLE DATABASE ALL SAVE STATE INSTANCES=ALL;
```

This step ensures that the PDB relocation operation automatically starts the PDB services in the target CDB.

- In the target CDB, the current user must have the `CREATE PLUGGABLE DATABASE` system privilege in the CDB root.
- If the target CDB is not in `ARCHIVELOG` mode, then the PDB must be in open read-only mode during the operation. This requirement does not apply if the target CDB is in `ARCHIVELOG` mode.
- The following prerequisites apply to the database link located in the target CDB:
  - A database link must enable a connection from the target CDB to the source CDB. The database link must connect to the root of the source CDB. If the PDB is an application PDB, then the database link must connect to its application root.
  - The user that the database link connects with in the PDB's current CDB must have either the `CREATE PLUGGABLE DATABASE` system privilege or the `SYSOPER` administrative privilege.
  - If the database link connects to the CDB root in the PDB's current CDB, then the user that the database link connects with must be a common user.
- The platforms of the source CDB and the target CDB must meet the following requirements:
  - They must have the same endianness.
  - The database options installed on the source platform must be the same as, or a subset of, the database options installed on the target platform.
- If the character set of the target CDB is not `AL32UTF8`, then the PDB's current CDB and the CDB to which it is being relocated must have compatible character sets and national character sets.

If the character set of the target CDB is `AL32UTF8`, then this requirement does not apply.
- If you are creating an application PDB, then the source PDB and target application container must have the same application name and version.

#### To relocate a PDB:

1. In SQL\*Plus, log in to the target CDB as a user with the `CREATE PLUGGABLE DATABASE` system privilege.
2. Ensure that the current container is the root of the target CDB or target application container.
3. Run the `CREATE PLUGGABLE DATABASE ... RELOCATE` statement with the `FROM` clause.

Specify the source PDB in the `FROM` clause, and include the `RELOCATE` clause. To redirect connections from the old location of the PDB to the new location, specify the `AVAILABILITY MAX` clause. Specify other clauses when they are required.

After you relocate the PDB, it is in mounted mode, and its status is `RELOCATING`. You can view the open mode of a PDB by querying the `OPEN_MODE` column in the `V$PDBS` view. You can view the status of a PDB by querying the `STATUS` column of the `CDB_PDBS` or `DBA_PDBS` view.

A new default service is created for the PDB. The service has the same name as the PDB and can be used to access the PDB. Oracle Net Services must be configured properly for clients to access this service.

4. Optionally, to determine the status of the file copy operation, query `V$SESSION_LONGOPS`.

The `OPNAMES` column shows `kpdbfCopyTaskCbk` for the data file copy and `kcrfremnoc` for the redo file copy.

5. Open the new PDB in read/write mode.

This step is required to complete the integration of the new PDB into the CDB. After the PDB is opened in read/write mode, its status is `NORMAL`. An error is returned if you attempt to open the PDB in read-only mode.

6. Back up the PDB.

A PDB cannot be recovered unless it is backed up.

#### Note:

If an error is returned during PDB relocation, then the PDB being created might be in an `UNUSABLE` state. You can check the PDB state by querying the `CDB_PDBS` or `DBA_PDBS` view, and you can learn more about PDB creation errors by checking the alert log. An unusable PDB can only be dropped, and it must be dropped before a PDB with the same name as the unusable PDB can be created.

### Example 8-1 Relocating a PDB from a Remote CDB

In this example, the root to which the new PDB belongs depends on the current container when the `CREATE PLUGGABLE DATABASE` statement is run:

- When the current container is the CDB root, the new PDB is created in the CDB root.
- When the current container is an application root in an application container, the new PDB is created as an application PDB in the application root.

This example relocates a PDB named `pdb1` from a remote CDB given different factors. This example assumes the following factors:

- The current user has the `CREATE PLUGGABLE DATABASE` system privilege in the root of the target CDB.
- The database link name to the source CDB is `lnk2src`. This database link was created with the following SQL statement:

```
CREATE PUBLIC DATABASE LINK lnk2src CONNECT TO c##myadmin IDENTIFIED
BY password USING 'MYCDB';
```

The common user `c##myadmin` has `SYSOPER` administrative privilege and `CREATE PLUGGABLE DATABASE` system privilege in the source CDB.

- The `PATH_PREFIX` clause is not required.
- The `FILE_NAME_CONVERT` clause and the `CREATE_FILE_DEST` clause are not required.

Either Oracle Managed Files is enabled, or the `PDB_FILE_NAME_CONVERT` initialization parameter is set. The files will be moved to a new location based on the Oracle Managed Files configuration or the initialization parameter setting.

- Storage limits are not required for the PDB. Therefore, the `STORAGE` clause is not required.
- There is no file with the same name as the new temp file that will be created in the target location. Therefore, the `TEMPFILE REUSE` clause is not required.
- Connections should be relocated automatically from the source PDB to the relocated PDB. Therefore, the `AVAILABILITY MAX` clause is included.

The following statement relocates the `pdb1` PDB from the source CDB to the current CDB:

```
CREATE PLUGGABLE DATABASE pdb1 FROM pdb1@lnk2src RELOCATE AVAILABILITY MAX;
```

#### See Also:

- ["About the CDB Undo Mode"](#)
- ["Modifying the Open Mode of One or More PDBs"](#)
- *Oracle Database Globalization Support Guide* for the compatibility requirements for character sets and national character sets
- *Oracle Database Backup and Recovery User's Guide* for information about backing up a PDB

# 9

## Plugging In an Unplugged PDB

You can create a PDB by plugging an unplugged PDB into a CDB.

This chapter contains the following topics:

- [About Plugging In an Unplugged PDB](#)  
The `USING` clause of the `CREATE PLUGGABLE DATABASE` statement specifies a XML metadata file or a compressed archive file with a `.pdb` extension.
- [About Adopting a Non-CDB as a PDB](#)  
To generate an XML file that describes a non-CDB, use the `DBMS_PDB.DESCRIBE` procedure. Afterward, plug in the non-CDB just as you plug in an unplugged PDB.
- [Plugging In an Unplugged PDB](#)  
Plug in a PDB with the `CREATE PLUGGABLE DATABASE ... USING` statement.
- [Adopting a Non-CDB as a PDB](#)  
You can adopt (move) a non-CDB into a PDB by using the `DBMS_PDB.DESCRIBE` procedure.
- [After Plugging in an Unplugged PDB](#)  
Certain rules regarding users and tablespaces apply after plugging in an unplugged PDB.
- [Plugging in an Unplugged PDB: Examples](#)  
These examples plug in an unplugged PDB named `salespdb` using the `/disk1/usr/salespdb.xml` file or the `/disk1/usr/sales.pdb` file given different factors.

### 9.1 About Plugging In an Unplugged PDB

The `USING` clause of the `CREATE PLUGGABLE DATABASE` statement specifies a XML metadata file or a compressed archive file with a `.pdb` extension.

This section contains the following topics:

- [About the XML File and Archive File](#)  
An XML metadata file describes the unplugged PDB and the files associated with the PDB (such as the data files and wallet file). An archive file includes both the XML metadata file and the PDB files.
- [Source File Locations When Plugging In an Unplugged PDB](#)  
Use the `CREATE PLUGGABLE DATABASE ... USING` statement to plug an unplugged PDB into a CDB.

#### 9.1.1 About the XML File and Archive File

An XML metadata file describes the unplugged PDB and the files associated with the PDB (such as the data files and wallet file). An archive file includes both the XML metadata file and the PDB files.

When the XML metadata file is specified, the XML file includes the full paths of the PDB files. When the .pdb archive file is specified, the XML metadata file contains the relative file names only.

The following figure illustrates how to plug in an unplugged PDB.

**Figure 9-1 Plugging an Unplugged PDB Into a CDB Root**

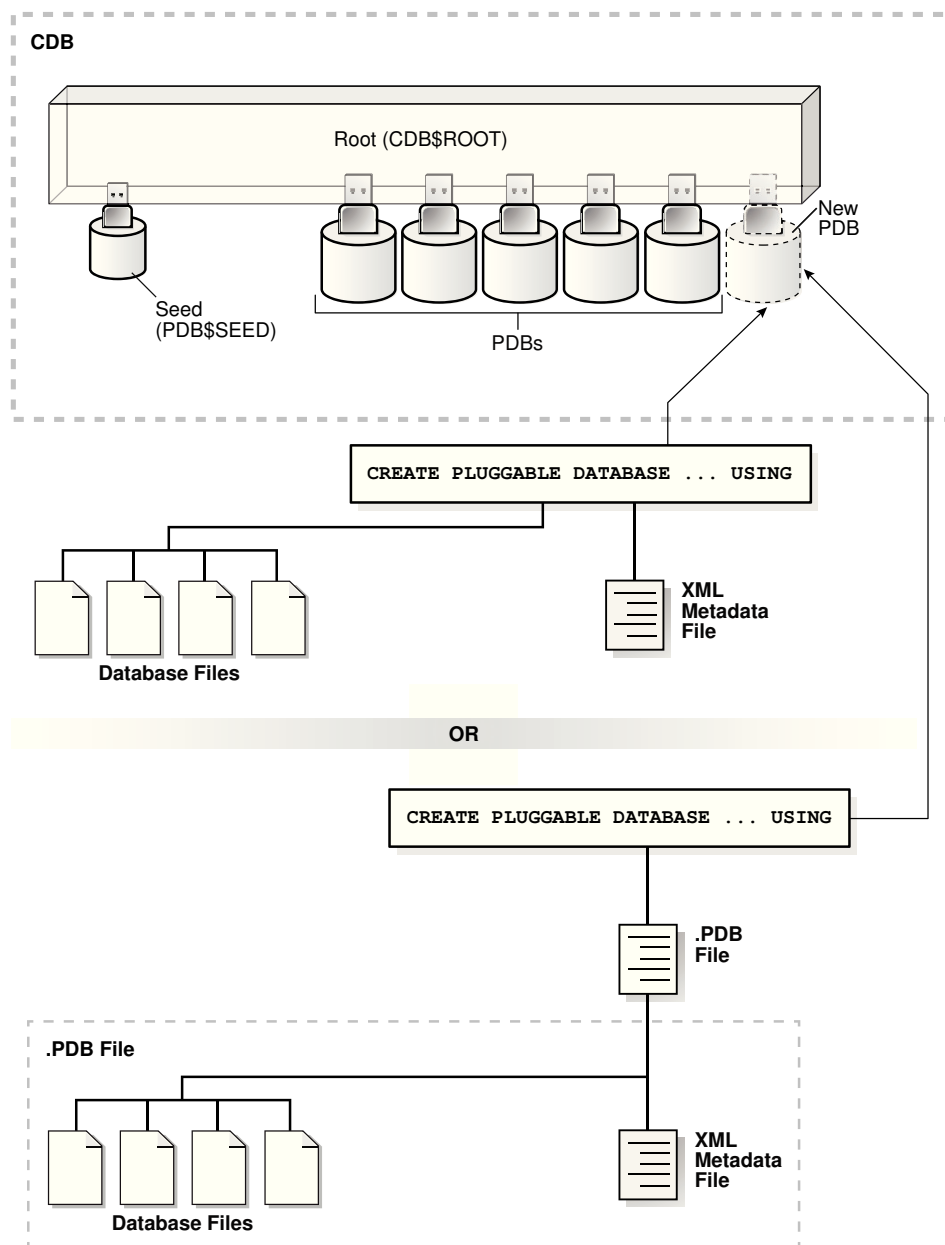

The following figure illustrates how this technique creates a new application PDB in an application container.

Figure 9-2 Plugging an Unplugged PDB Into an Application Root

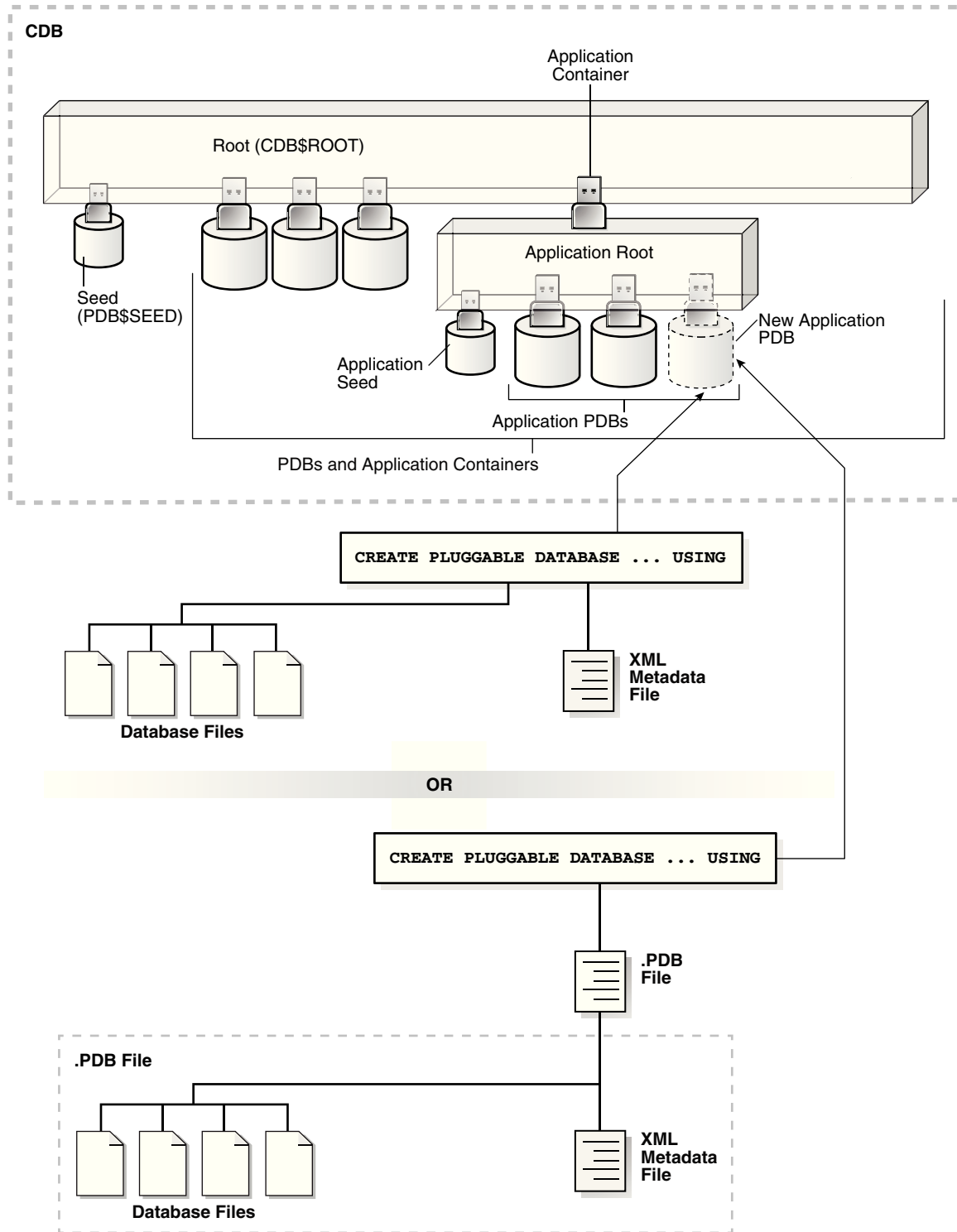



 **Note:**

Automatic downgrade of a PDB is not supported. Therefore, you cannot plug in a PDB if the source CDB is a higher Oracle Database release than the target CDB.

When you plug in an unplugged PDB, you must address the questions that apply to plugging in an unplugged PDB in [Table 5-3](#). The table describes which `CREATE PLUGGABLE DATABASE` clauses you must specify based on different factors.

 **See Also:**

- ["PDB Storage"](#)
- ["Creating an Application PDB"](#)

## 9.1.2 Source File Locations When Plugging In an Unplugged PDB

Use the `CREATE PLUGGABLE DATABASE ... USING` statement to plug an unplugged PDB into a CDB.

When you use a `.pdb` archive file when plugging in a PDB, Oracle Database extracts this file when you plug in the PDB, and places the PDB files in the same directory as the `.pdb` archive file. Therefore, the clauses that specify the source file locations are not required when you use a `.pdb` archive file.

When you specify an XML metadata file when plugging in a PDB, this file describes the names and locations of an unplugged PDB source files. The XML file might not describe the locations of these files accurately if you transported the unplugged files from one storage system to a different one. The files are in a new location, but the file paths in the XML file still indicate the old location.

When plugging in an unplugged PDB using an XML metadata file (not a `.pdb` archive file), use either the `SOURCE_FILE_NAME_CONVERT` clause or the `SOURCE_FILE_DIRECTORY` clause. These clauses are mutually exclusive.

This section contains the following topics:

- [SOURCE\\_FILE\\_NAME\\_CONVERT Clause](#)  
The `SOURCE_FILE_NAME_CONVERT` clause specifies how to locate PDB files when they reside in a location different from that specified in the XML file.
- [SOURCE\\_FILE\\_DIRECTORY Clause](#)  
The `SOURCE_FILE_DIRECTORY` clause specifies the source directory of the files that will be used to create the new PDB.

### 9.1.2.1 SOURCE\_FILE\_NAME\_CONVERT Clause

The `SOURCE_FILE_NAME_CONVERT` clause specifies how to locate PDB files when they reside in a location different from that specified in the XML file.

You can use this clause to specify one of the following options:

- One or more file name patterns and replacement file name patterns, in the following form:

```
'string1' , 'string2' , 'string3' , 'string4' , ...
```

The *string2* file name pattern replaces the *string1* file name pattern, and the *string4* file name pattern replaces the *string3* file name pattern. You can use as many pairs of file name pattern and replacement file name pattern strings as required.

When you use this clause, ensure that the files you want to use for the PDB reside in the replacement file name patterns. Move or copy the files to these locations if necessary.

- NONE when no file names need to be located because the PDB's XML file describes the file names accurately. Omitting the `SOURCE_FILE_NAME_CONVERT` clause is the same as specifying NONE.

You can use the `SOURCE_FILE_NAME_CONVERT` clause only in a `CREATE PLUGGABLE DATABASE` statement with a `USING` clause that specifies an XML metadata file. Therefore, you can use this clause only when you are plugging in an unplugged PDB with an XML metadata file. You cannot use this clause when you are plugging in a PDB with a .pdb archive file.

#### Example 9-1 SOURCE\_FILE\_NAME\_CONVERT Clause

This `SOURCE_FILE_NAME_CONVERT` clause uses the files in the `/disk2/oracle/pdb7` directory instead of the `/disk1/oracle/pdb7` directory. In this case, the XML file describing a PDB specifies the `/disk1/oracle/pdb7` directory, but the PDB should use the files in the `/disk2/oracle/pdb7` directory.

```
SOURCE_FILE_NAME_CONVERT = ('/disk1/oracle/pdb7/', '/disk2/oracle/pdb7/')
```

#### See Also:

- [Plugging In an Unplugged PDB](#)
- *Oracle Database SQL Language Reference* for the syntax of the `SOURCE_FILE_NAME_CONVERT` clause

### 9.1.2.2 SOURCE\_FILE\_DIRECTORY Clause

The `SOURCE_FILE_DIRECTORY` clause specifies the source directory of the files that will be used to create the new PDB.

The clause specifies a directory that contains all of the files listed in the XML file. Using this clause is convenient when you have many data files and specifying a `SOURCE_FILE_NAME_CONVERT` pattern for each file is not feasible.

When you plug in a PDB, if the source files are all present in a single directory, then you can specify the directory name in this clause. The directory is scanned to find the appropriate files based on the unplugged PDB's XML file.

You can use this clause to specify one of the following options:

- The absolute path of the source file directory.

- `NONE` when no files should be copied or moved during PDB creation. Omitting the `SOURCE_FILE_DIRECTORY` clause is the same as specifying `NONE`.

You can use the `SOURCE_FILE_DIRECTORY` clause only in a `CREATE PLUGGABLE DATABASE` statement with a `USING` clause that specifies an XML metadata file. Therefore, you can use this clause only when you are plugging in an unplugged PDB with an XML metadata file. You cannot use this clause when you are plugging in a PDB with a `.pdb` archive file.

You can specify this clause for configurations that use Oracle Managed Files and for configurations that do not use Oracle Managed Files.

### Example 9-2 `SOURCE_FILE_DIRECTORY` Clause

This `SOURCE_FILE_DIRECTORY` clause generates file names for the new PDB by using the source files in the `/oracle/pdb5/` directory.

```
SOURCE_FILE_DIRECTORY = '/oracle/pdb5/'
```

#### See Also:

- [Plugging In an Unplugged PDB](#)
- *Oracle Database SQL Language Reference* for the syntax of the `SOURCE_FILE_DIRECTORY` clause

## 9.2 About Adopting a Non-CDB as a PDB

To generate an XML file that describes a non-CDB, use the `DBMS_PDB.DESCRIBE` procedure. Afterward, plug in the non-CDB just as you plug in an unplugged PDB.

Create the PDB with the `CREATE PLUGGABLE DATABASE ... USING` statement. When the non-CDB is plugged in to a CDB, it is a PDB.

Figure 9-3 Plug In a Non-CDB Using the DBMS\_PDB.DESCRIBE Procedure

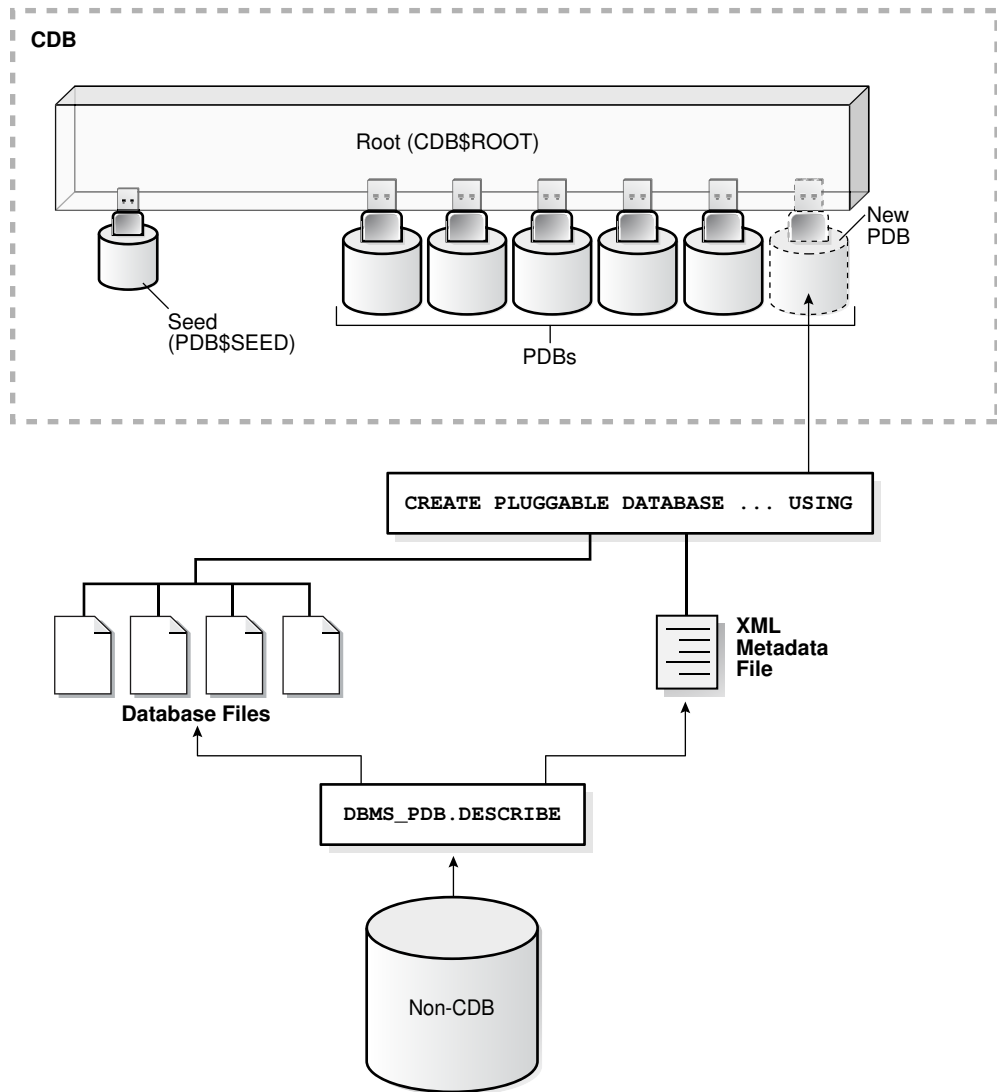

You can use the same technique to create a new application PDB in an application container.

 **Note:**

To use this technique, the non-CDB must be at release Oracle Database 12c or later.

**See Also:**

"Plugging In an Unplugged PDB"

## 9.3 Plugging In an Unplugged PDB

Plug in a PDB with the `CREATE PLUGGABLE DATABASE ... USING` statement.

### General Prerequisites

To plug in an unplugged PDB, the following prerequisites must be met:

- Complete the prerequisites described in "[General Prerequisites for PDB Creation](#)".
- Either the XML file that describes the PDB or the `.pdb` archive file must exist in a location that is accessible to the CDB.

The `USING` clause must specify the XML file or the `.pdb` archive file. If the PDB's XML file is unusable or cannot be located, then use the `DBMS_PDB.RECOVER` procedure to generate an XML file using the PDB's data files.

- If an XML file (not a `.pdb` file) is specified in the `USING` clause, then the files associated with the PDB (such as the data files and wallet file) must exist in a location that is accessible to the CDB.
- If the target database for the plugin operation is the primary database in an Oracle Data Guard configuration, then ensure that the standby database can locate the files for the plugged-in PDB.

On the standby database, set the `STANDBY_PDB_SOURCE_FILE_DIRECTORY` initialization parameter to a location that contains the source data files for instantiating the PDB. If the files are not found, then the standby database tries to locate the files in the OMF location. If not found in the OMF location, then you must copy the data files to the OMF location on the standby database, and restart redo apply on the standby database.

- The source and target CDB platforms must meet the following requirements:
  - They must have the same endianness.
  - The database options installed on the source platform must be the same as, or a subset of, the database options installed on the target platform.
- If you are creating an application PDB, then the application name and version of the unplugged PDB must match the application name and version of the application container into which the application PDB is being plugged.

### Character Set Prerequisites

You must meet the following prerequisites for matching the character sets:

- If the character set of the CDB into which the PDB is being plugged is not `AL32UTF8`, then the CDB that contained the unplugged PDB and the target CDB must have compatible character sets and national character sets. To be compatible, the character sets and national character sets must meet the requirements specified in *Oracle Database Globalization Support Guide*.

If the character set of the CDB into which the PDB is being plugged is AL32UTF8, then this requirement does not apply.

- If you are creating an application PDB, then the application PDB must have the same character set and national character set as the application container.

If the database character set of the CDB is AL32UTF8, then the character set and national character set of the application container can be different from the CDB. However, all application PDBs in an application container must have same character set and national character set, matching that of the application container.

To determine whether the preceding requirements are met, use the `DBMS_PDB.CHECK_PLUG_COMPATIBILITY` function. Step 2 in the following procedure describes using this function.

### To plug in a PDB:

1. In SQL\*Plus, ensure that the current container is the CDB root or application root of the target CDB.

When the current container is the CDB root, the PDB is created in the CDB. When the current container is an application root, the application PDB is created in the application container.

2. (Optional) Run the `DBMS_PDB.CHECK_PLUG_COMPATIBILITY` function to determine whether the unplugged PDB is compatible with the CDB.
  - a. If the PDB is not yet unplugged, then run the `DBMS_PDB.DESCRIBE` procedure to produce an XML file that describes the PDB.

If the PDB is already unplugged, then proceed to Step 2b.

For example, to generate an XML file named `salespdb.xml` in the `/disk1/oracle` directory, run the following procedure:

```
BEGIN
  DBMS_PDB.DESCRIBE(
    pdb_descr_file => '/disk1/oracle/salespdb.xml',
    pdb_name       => 'SALESPDB');
END;
/
```

If the PDB is in a remote CDB, then you can include `@database_link_name` in the `pdb_name` parameter, where `database_link_name` is the name of a valid database link to the remote CDB or to the PDB. For example, if the database link name to the remote CDB is `rcdb`, then set the `pdb_name` value to `SALESPDB@rcdb`.

- b. Run the `DBMS_PDB.CHECK_PLUG_COMPATIBILITY` function.

When you run the function, set the following parameters:

- `pdb_descr_file` - Set this parameter to the full path to the XML file.
- `pdb_name` - Specify the name of the new PDB. If this parameter is omitted, then the PDB name in the XML file is used.

For example, to determine whether a PDB described by the `/disk1/usr/salespdb.xml` file is compatible with the current CDB, run the following PL/SQL block:

```
SET SERVEROUTPUT ON
DECLARE
  compatible CONSTANT VARCHAR2(3) :=
    CASE DBMS_PDB.CHECK_PLUG_COMPATIBILITY(
      pdb_descr_file => '/disk1/usr/salespdb.xml',
      pdb_name       => 'SALESPDB')
    WHEN TRUE THEN 'YES'
    ELSE 'NO'
END;
BEGIN
  DBMS_OUTPUT.PUT_LINE(compatible);
END;
/
```

If the output is `YES`, then the PDB is compatible, and you can continue with the next step. If the output is `NO`, then the PDB is not compatible: check the `PDB_PLUG_IN_VIOLATIONS` view to see why it is not compatible.

 **Note:**

You can specify a `.pdb` archive file in the `pdb_descr_file` parameter.

3. If the PDB is not unplugged, then unplug it.
4. Run the `CREATE PLUGGABLE DATABASE ... USING` statement, specifying the XML file or the `.pdb` archive file in the `USING` clause. Specify other clauses when they are required.

After you create the PDB, it is in mounted mode, and its status is `NEW`. You can view the open mode of a PDB by querying the `OPEN_MODE` column in the `V$PDBS` view. You can view the status of a PDB by querying the `STATUS` column of the `CDB_PDBS` or `DBA_PDBS` view.

A new default service is created for the PDB. The service has the same name as the PDB and can be used to access the PDB. Oracle Net Services must be configured properly for clients to access this service.

5. Open the new PDB in read/write mode.

You must open the new PDB in read/write mode for Oracle Database to complete the integration of the new PDB into the CDB. An error is returned if you attempt to open the PDB in read-only mode. After the PDB is opened in read/write mode, its status is `NORMAL`.

6. Back up the PDB.

A PDB cannot be recovered unless it is backed up.

 **Note:**

If an error is returned during PDB creation, then the PDB being created might be in an `UNUSABLE` state. You can check a PDB's state by querying the `CDB_PDBS` or `DBA_PDBS` view, and you can learn more about PDB creation errors by checking the alert log. An unusable PDB can only be dropped, and it must be dropped before a PDB with the same name as the unusable PDB can be created.

 **See Also:**

- ["Unplugging a PDB from a CDB"](#)
- ["Modifying the Open Mode of One or More PDBs"](#) for more information.
- *Oracle Database Backup and Recovery User's Guide* for information about backing up a PDB.
- *Oracle Data Guard Concepts and Administration* to learn more about plugging in a PDB in an Oracle Data Guard environment
- *Oracle Database Reference* for information about the `PDB_FILE_NAME_CONVERT` initialization parameter
- *Oracle Database PL/SQL Packages and Types Reference* for more information about this procedure.

## 9.4 Adopting a Non-CDB as a PDB

You can adopt (move) a non-CDB into a PDB by using the `DBMS_PDB.DESCRIBE` procedure.

**To adopt a non-CDB as a PDB using the `DBMS_PDB` package:**

1. Create the CDB if it does not exist.
2. Ensure that the non-CDB is in a transactionally-consistent state.
3. Place the non-CDB in read-only mode.
4. Connect to the non-CDB, and run the `DBMS_PDB.DESCRIBE` procedure to construct an XML file that describes the non-CDB.

The current user must have `SYSDBA` administrative privilege. The user must exercise the privilege using `AS SYSDBA` at connect time.

For example, to generate an XML file named `ncdb.xml` in the `/disk1/oracle` directory, run the following procedure:

```
BEGIN
  DBMS_PDB.DESCRIBE(
    pdb_descr_file => '/disk1/oracle/ncdb.xml');
```



```
END;
/
```

After the procedure completes successfully, you can use the XML file and the non-CDB database files to plug the non-CDB into a CDB.

5. Run the `DBMS_PDB.CHECK_PLUG_COMPATIBILITY` function to determine whether the non-CDB is compatible with the CDB.

When you run the function, set the following parameters:

- `pdb_descr_file` - Set this parameter to the full path to the XML file.
- `pdb_name` - Specify the name of the new PDB. If this parameter is omitted, then the PDB name in the XML file is used.

For example, to determine whether a non-CDB described by the `/disk1/oracle/ncdb.xml` file is compatible with the current CDB, run the following PL/SQL block:

```
SET SERVEROUTPUT ON
DECLARE
  compatible CONSTANT VARCHAR2(3) :=
    CASE DBMS_PDB.CHECK_PLUG_COMPATIBILITY(
      pdb_descr_file => '/disk1/oracle/ncdb.xml',
      pdb_name       => 'NCDB')
    WHEN TRUE THEN 'YES'
    ELSE 'NO'
END;
BEGIN
  DBMS_OUTPUT.PUT_LINE(compatible);
END;
/
```

If the output is `YES`, then the non-CDB is compatible, and you can continue with the next step. If the output is `NO`, then the non-CDB is not compatible, and you can check the `PDB_PLUG_IN_VIOLATIONS` view to see why it is not compatible. All violations must be corrected before you continue. For example, any version or patch mismatches should be resolved by running an upgrade or the `datapatch` utility. After correcting the violations, run `DBMS_PDB.CHECK_PLUG_COMPATIBILITY` again to ensure that the non-CDB is compatible with the CDB.

6. Shut down the non-CDB.
7. Plug in the non-CDB.

For example, the following SQL statement plugs in a non-CDB, copies its files to a new location, and includes only the `tbs3` user tablespace from the non-CDB:

```
CREATE PLUGGABLE DATABASE ncdb USING '/disk1/oracle/ncdb.xml'
  COPY
  FILE_NAME_CONVERT = ('/disk1/oracle/dbs/', '/disk2/oracle/ncdb/')
  USER_TABLESPACES=('tbs3');
```

If there are no violations, then do not open the new PDB. You will open it in the following step.

The `USER_TABLESPACES` clause enables you to separate data that was used for multiple tenants in a non-CDB into different PDBs. You can use multiple `CREATE PLUGGABLE DATABASE` statements with this clause to create other PDBs that include the data from other tablespaces that existed in the non-CDB.

8. Run the `ORACLE_HOME/rdbms/admin/noncdb_to_pdb.sql` script. This script must be run before the PDB can be opened for the first time.

If the PDB was not a non-CDB, then running the `noncdb_to_pdb.sql` script is not required. To run the `noncdb_to_pdb.sql` script, complete the following steps:

- a. Access the PDB.

The current user must have `SYSDBA` administrative privilege, and the privilege must be either commonly granted or locally granted in the PDB. The user must exercise the privilege using `AS SYSDBA` at connect time.

- b. Run the `noncdb_to_pdb.sql` script:

```
@$ORACLE_HOME/rdbms/admin/noncdb_to_pdb.sql
```

The script opens the PDB, performs changes, and closes the PDB when the changes are complete.

9. Open the new PDB in read/write mode.

You must open the new PDB in read/write mode for Oracle Database to complete the integration of the new PDB into the CDB. An error is returned if you attempt to open the PDB in read-only mode. After the PDB is opened in read/write mode, its status is `NORMAL`.

10. Back up the PDB.

A PDB cannot be recovered unless it is backed up.

#### Note:

If an error is returned during PDB creation, then the PDB being created might be in an `UNUSABLE` state. You can check a PDB's state by querying the `CDB_PDBS` or `DBA_PDBS` view, and you can learn more about PDB creation errors by checking the alert log. An unusable PDB can only be dropped, and it must be dropped before a PDB with the same name as the unusable PDB can be created.

## 9.5 After Plugging in an Unplugged PDB

Certain rules regarding users and tablespaces apply after plugging in an unplugged PDB.

The following applies after plugging in an unplugged PDB:

- User accounts in the PDB who used the default temporary tablespace of the source PDB use the default temporary tablespace of the target PDB. User accounts who used nondefault temporary tablespaces in the source PDB continue to use the same local temporary tablespaces in the target PDB.

- Manually created common user accounts that existed in the source CDB but not in the target CDB do not have privileges granted commonly. However, if the target CDB has a common user with the same name as a common user in the PDB, then the latter is linked to the former and has the privileges granted to this common user in the target CDB.

If the cloned or plugged-in PDB has a common user account that does not exist in the target CDB, and if this user does not own objects in the PDB, then Oracle Database drops the user during the synchronization step; otherwise, the user account is locked in the target PDB. You have the following options regarding locked accounts:

- Close the PDB, connect to the root, and create a common user account with the same name. When the PDB is opened in read/write mode, differences in roles and privileges granted commonly to the user account are resolved, and you can unlock the account. Privileges and roles granted locally to the user account remain unchanged during this process.
- Create a new local user account in the PDB and use Data Pump to export/import the locked user's data into the new local user's schema.
- Leave the user account locked.
- Drop the user account.



#### See Also:

- ["Managing Services for PDBs"](#)
- ["About Managing Tablespaces in a CDB"](#)
- *Oracle Database Concepts* for information about common users and local users
- *Oracle Database Security Guide* for information about creating common users and local users in a CDB
- *Oracle Database Utilities* for information about using Oracle Data Pump with a CDB

## 9.6 Plugging in an Unplugged PDB: Examples

These examples plug in an unplugged PDB named `salespdb` using the `/disk1/usr/salespdb.xml` file or the `/disk1/usr/sales.pdb` file given different factors.

In each example, the root to which the new PDB belongs depends on the current container when the `CREATE PLUGGABLE DATABASE` statement is run:

- When the current container is the CDB root, the new PDB is created in the CDB.
- When the current container is an application root, the new application PDB is created in the application root's application container.

### Example 9-3 Plugging In an Unplugged PDB Using the NOCOPY Clause

This example assumes the following factors:

- The new PDB is not based on the same unplugged PDB that was used to create an existing PDB in the CDB. Therefore, the `AS CLONE` clause is not required.
- The `PATH_PREFIX` clause is not required.
- The XML file accurately describes the current locations of the files. Therefore, the `SOURCE_FILE_NAME_CONVERT` clause or `SOURCE_FILE_DIRECTORY` clause is not required.
- The files are in the correct location. Therefore, `NOCOPY` is included.
- Storage limits are not required for the PDB. Therefore, the `STORAGE` clause is not required.
- A file with the same name as the temp file specified in the XML file exists in the target location. Therefore, the `TEMPFILE REUSE` clause is required.

Given the preceding factors, the following statement plugs in the PDB:

```
CREATE PLUGGABLE DATABASE salespdb USING '/disk1/usr/salespdb.xml'  
    NOCOPY  
    TEMPFILE REUSE;
```

#### Example 9-4 Plugging In an Unplugged PDB Using the `AS CLONE` and `NOCOPY` Clauses

This example assumes the following factors:

- The new PDB is based on the same unplugged PDB that was used to create an existing PDB in the CDB. Therefore, the `AS CLONE` clause is required. The `AS CLONE` clause ensures that the new PDB has unique identifiers.
- The `PATH_PREFIX` clause is not required.
- The XML file accurately describes the current locations of the files. Therefore, the `SOURCE_FILE_NAME_CONVERT` clause or `SOURCE_FILE_DIRECTORY` clause is not required.
- The files are in the correct location. Therefore, `NOCOPY` is included.
- Storage limits are not required for the PDB. Therefore, the `STORAGE` clause is not required.
- A file with the same name as the temp file specified in the XML file exists in the target location. Therefore, the `TEMPFILE REUSE` clause is required.

Given the preceding factors, the following statement plugs in the PDB:

```
CREATE PLUGGABLE DATABASE salespdb AS CLONE USING '/disk1/usr/  
salespdb.xml'  
    NOCOPY  
    TEMPFILE REUSE;
```

#### Example 9-5 Plugging In an Unplugged PDB Using the `SOURCE_FILE_NAME_CONVERT`, `NOCOPY`, and `STORAGE` Clauses

This example assumes the following factors:

- The new PDB is not based on the same unplugged PDB that was used to create an existing PDB in the CDB. Therefore, the `AS CLONE` clause is not required.

- The `PATH_PREFIX` clause is not required.
- The XML file does not accurately describe the current locations of the files. Therefore, the `SOURCE_FILE_NAME_CONVERT` clause or `SOURCE_FILE_DIRECTORY` clause is required. In this example, the XML file indicates that the files are in `/disk1/oracle/sales`, but the files are in `/disk2/oracle/sales`, and the `SOURCE_FILE_NAME_CONVERT` clause is used.
- The files are in the correct location. Therefore, `NOCOPY` is included.
- Storage limits must be enforced for the PDB. Therefore, the `STORAGE` clause is required. Specifically, all tablespaces that belong to the PDB must not exceed 2 gigabytes.
- A file with the same name as the temp file specified in the XML file exists in the target location. Therefore, the `TEMPFILE REUSE` clause is required.

Given the preceding factors, the following statement plugs in the PDB:

```
CREATE PLUGGABLE DATABASE salespdb USING '/disk1/usr/salespdb.xml'
  SOURCE_FILE_NAME_CONVERT = ('/disk1/oracle/sales/', '/disk2/oracle/
sales/')
  NOCOPY
  STORAGE (MAXSIZE 2G)
  TEMPFILE REUSE;
```

#### Example 9-6 Plugging In an Unplugged PDB With the `COPY`, `PATH_PREFIX`, and `FILE_NAME_CONVERT` Clauses

This example assumes the following factors:

- The new PDB is not based on the same unplugged PDB that was used to create an existing PDB in the CDB. Therefore, the `AS CLONE` clause is not required.
- The path prefix must be added to the PDB's directory object paths. Therefore, the `PATH_PREFIX` clause is required. In this example, the path prefix `/disk2/oracle/sales/` is added to the PDB's directory object paths.
- The XML file accurately describes the current locations of the files. Therefore, the `SOURCE_FILE_NAME_CONVERT` clause or `SOURCE_FILE_DIRECTORY` clause is not required.
- The files are not in the correct location. Therefore, `COPY` or `MOVE` must be included. In this example, the files are copied.

The `CREATE_FILE_DEST` clause is not used, Oracle Managed Files is not enabled, and the `PDB_FILE_NAME_CONVERT` initialization parameter is not set. Therefore, the `FILE_NAME_CONVERT` clause is required. In this example, the files are copied from `/disk1/oracle/sales` to `/disk2/oracle/sales`.

- Storage limits are not required for the PDB. Therefore, the `STORAGE` clause is not required.
- There is no file with the same name as the new temp file that will be created in the target location. Therefore, the `TEMPFILE REUSE` clause is not required.

Given the preceding factors, the following statement plugs in the PDB:

```
CREATE PLUGGABLE DATABASE salespdb USING '/disk1/usr/salespdb.xml'
  COPY
```

```
PATH_PREFIX = '/disk2/oracle/sales/'
FILE_NAME_CONVERT = ('/disk1/oracle/sales/', '/disk2/oracle/sales/');
```

### Example 9-7 Plugging In an Unplugged PDB Using the SOURCE\_FILE\_NAME\_CONVERT, MOVE, FILE\_NAME\_CONVERT, and STORAGE Clauses

This example assumes the following factors:

- The new PDB is not based on the same unplugged PDB that was used to create an existing PDB in the CDB. Therefore, the `AS CLONE` clause is not required.
- The `PATH_PREFIX` clause is not required.
- The XML file does not accurately describe the current locations of the files. Therefore, the `SOURCE_FILE_NAME_CONVERT` clause or `SOURCE_FILE_DIRECTORY` clause is required. In this example, the XML file indicates that the files are in `/disk1/oracle/sales`, but the files are in `/disk2/oracle/sales`, and the `SOURCE_FILE_NAME_CONVERT` clause is used.
- The files are not in the correct final location for the PDB. Therefore, `COPY` or `MOVE` must be included. In this example, `MOVE` is specified to move the files.

The `CREATE_FILE_DEST` clause is not used, Oracle Managed Files is not enabled, and the `PDB_FILE_NAME_CONVERT` initialization parameter is not set. Therefore, the `FILE_NAME_CONVERT` clause is required. In this example, the files are moved from `/disk2/oracle/sales` to `/disk3/oracle/sales`.

- Storage limits must be enforced for the PDB. Therefore, the `STORAGE` clause is required. Specifically, all tablespaces that belong to the PDB must not exceed 2 gigabytes.
- There is no file with the same name as the new temp file that will be created in the target location. Therefore, the `TEMPFILE REUSE` clause is not required.

Given the preceding factors, the following statement plugs in the PDB:

```
CREATE PLUGGABLE DATABASE salespdb USING '/disk1/usr/salespdb.xml'
SOURCE_FILE_NAME_CONVERT = ('/disk1/oracle/sales/', '/disk2/oracle/
sales/')
MOVE
FILE_NAME_CONVERT = ('/disk2/oracle/sales/', '/disk3/oracle/sales/')
STORAGE (MAXSIZE 2G);
```

### Example 9-8 Plugging In an Unplugged PDB Using the SOURCE\_FILE\_DIRECTORY, MOVE, FILE\_NAME\_CONVERT, and STORAGE Clauses

This example assumes the following factors:

- The new PDB is not based on the same unplugged PDB that was used to create an existing PDB in the CDB. Therefore, the `AS CLONE` clause is not required.
- The `PATH_PREFIX` clause is not required.
- The XML file does not accurately describe the current locations of the files. Therefore, the `SOURCE_FILE_NAME_CONVERT` clause or `SOURCE_FILE_DIRECTORY` clause is required. In this example, the XML file indicates that the files are in /

disk1/oracle/sales, but the files are in /disk2/oracle/sales, and the `SOURCE_FILE_DIRECTORY` clause is used.

- The files are not in the correct final location for the PDB. Therefore, `COPY` or `MOVE` must be included. In this example, `MOVE` is specified to move the files.

The `CREATE_FILE_DEST` clause is not used, Oracle Managed Files is not enabled, and the `PDB_FILE_NAME_CONVERT` initialization parameter is not set. Therefore, the `FILE_NAME_CONVERT` clause is required. In this example, the files are moved from /disk2/oracle/sales to /disk3/oracle/sales.

- Storage limits must be enforced for the PDB. Therefore, the `STORAGE` clause is required. Specifically, all tablespaces that belong to the PDB must not exceed 2 gigabytes.
- There is no file with the same name as the new temp file that will be created in the target location. Therefore, the `TEMPFILE REUSE` clause is not required.

Given the preceding factors, the following statement plugs in the PDB:

```
CREATE PLUGGABLE DATABASE salespdb USING '/disk1/usr/salespdb.xml'  
SOURCE_FILE_DIRECTORY = '/disk2/oracle/sales/'  
MOVE  
FILE_NAME_CONVERT = ('/disk2/oracle/sales/', '/disk3/oracle/sales/')  
STORAGE (MAXSIZE 2G);
```

### Example 9-9 Plugging In an Unplugged PDB Using an Archive File

This example assumes the following factors:

- The unplugged PDB is in a .pdb archive file named `sales.pdb`. The archive file includes the XML metadata file and the PDB's files (such as the data files and wallet file) in compressed form, and these files are extracted to the current directory of the .pdb archive file when the `CREATE PLUGGABLE DATABASE` statement is run.
- The new PDB is not based on the same unplugged PDB that was used to create an existing PDB in the CDB. Therefore, the `AS CLONE` clause is not required.
- The `PATH_PREFIX` clause is not required.
- Storage limits must be enforced for the PDB. Therefore, the `STORAGE` clause is required. Specifically, all tablespaces that belong to the PDB must not exceed 2 gigabytes.
- There is no file with the same name as the new temp file that will be created in the target location. Therefore, the `TEMPFILE REUSE` clause is not required.

Given the preceding factors, the following statement plugs in the PDB using an archive file:

i

# 10

## Creating a PDB as a Proxy PDB

You can create a PDB as a proxy PDB by referencing it in a remote CDB.

This chapter contains the following topics:

- [About Creating a Proxy PDB](#)  
A **proxy PDB** provides access to a PDB in a remote CDB. It is analogous to a symbolic link.
- [Creating a Proxy PDB](#)  
Create a proxy PDB by referencing a PDB in a different CDB.

### 10.1 About Creating a Proxy PDB

A **proxy PDB** provides access to a PDB in a remote CDB. It is analogous to a symbolic link.

The `CREATE PLUGGABLE DATABASE` statement creates a proxy PDB by referencing a PDB in a different CDB, which is called the **referenced PDB**. You can use a proxy PDB when you want a local context for a remote PDB. In addition, when application containers in different CDBs have the same application, you can keep their application roots synchronized with a proxy PDB.

To use this technique, run the `CREATE PLUGGABLE DATABASE` statement in the CDB that will contain the proxy PDB. You must include:

- The `AS PROXY` clause to specify that you are creating a proxy PDB.
- A `FROM` clause that specifies the PDB that the proxy PDB is referencing.
- A database link to the current location of the referenced PDB in the `FROM` clause. The database link must be created in the root of the CDB that will contain the proxy PDB, and the database link connects either to the root of remote CDB or to the remote referenced PDB.

The following figure illustrates how this technique creates a proxy PDB that references a PDB in a remote CDB.



Figure 10-1 Create a Remote Proxy PDB

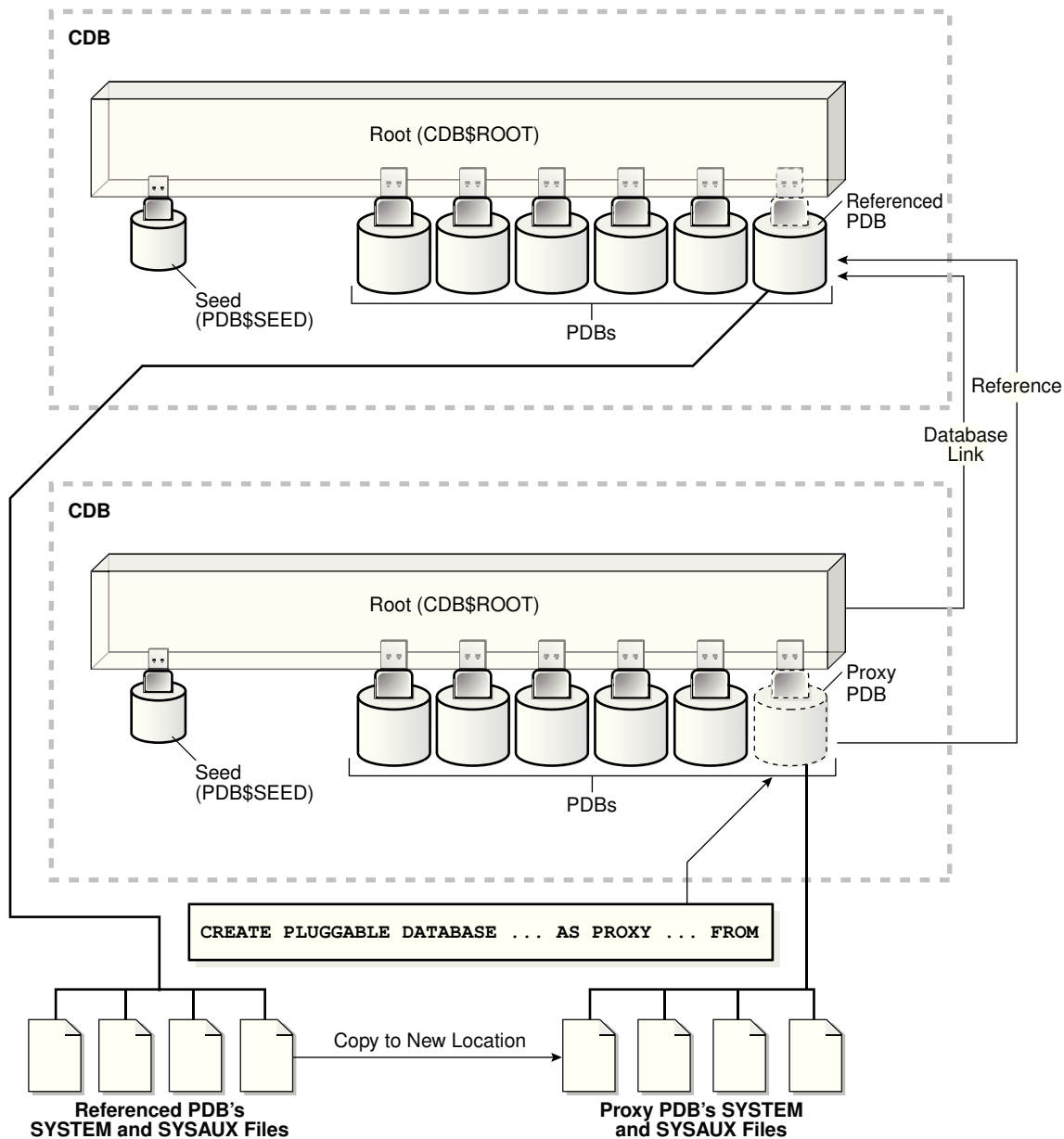

You can create a proxy PDB in an application container. To do so, the referenced PDB must be an application root or an application PDB in an application container in a different CDB. The database link must be created in the root of the application container that will contain the proxy PDB, and the database link connects either to the root of remote application container or to the remote referenced application PDB.

The following graphic illustrates how this technique creates a proxy PDB in an application container based on a remote referenced PDB in an application container.

Figure 10-2 Create a Remote Proxy PDB in an Application Container

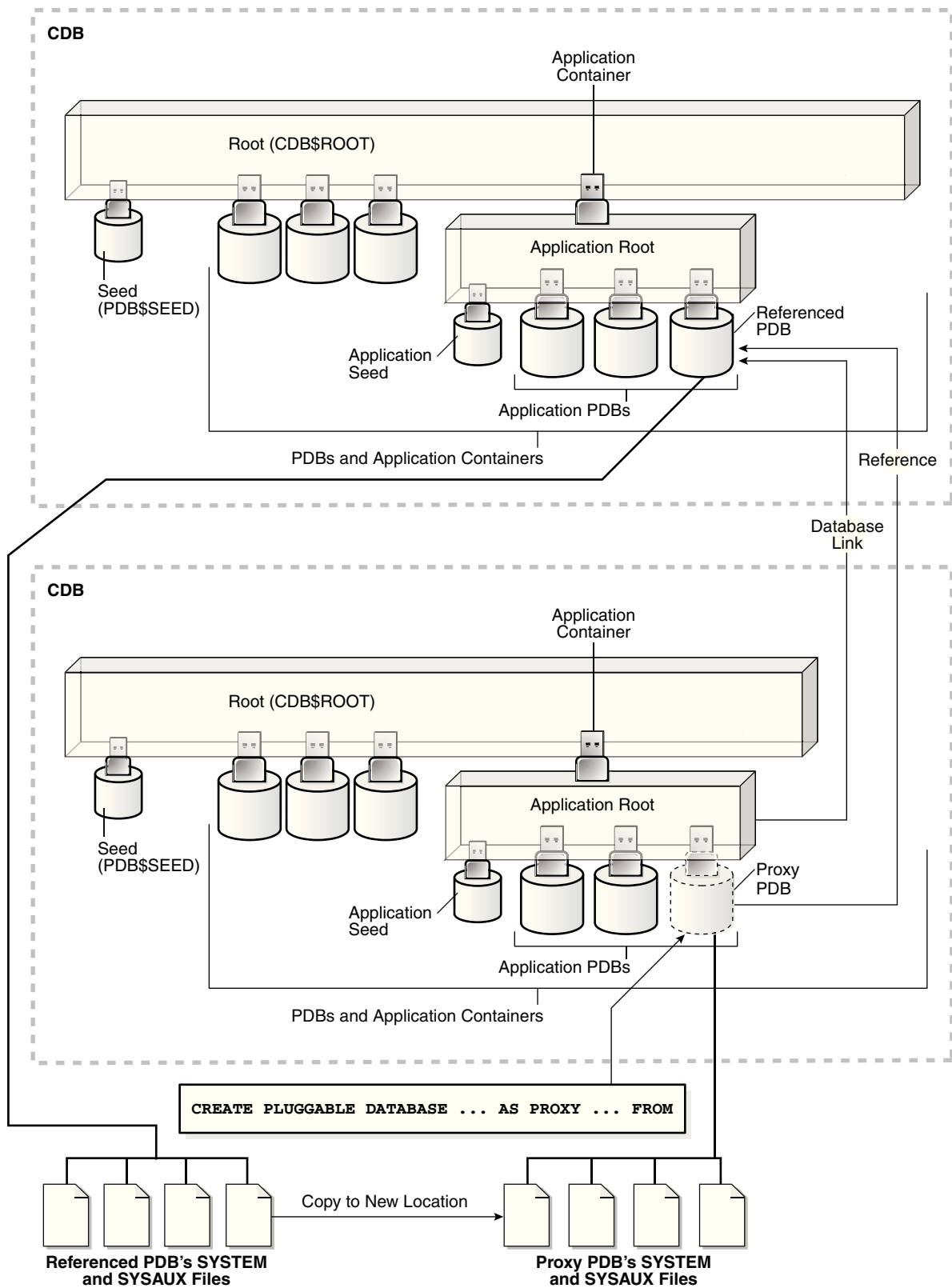

Before creating a proxy PDB, address the questions that apply to creating a proxy PDB in "Table 5-3". The table describes which `CREATE PLUGGABLE DATABASE` clauses you must specify based on different factors.

This section contains the following topics:

- [Proxy PDBs and SQL Statements](#)  
As a rule, when the proxy PDB is the current container, SQL statements submitted for execution in the proxy PDB are executed in the referenced PDB.
- [Proxy PDBs and Database Links](#)  
A database link is required when you create a proxy PDB.
- [Proxy PDBs and Authentication](#)  
Only password authentication is supported for sessions in a proxy PDB.
- [Proxy PDBs and the Listener](#)  
The host name and port number settings for a PDB are important only if proxy PDBs will reference the PDB.

 **See Also:**

- ["PDB Storage"](#)
- ["Synchronizing an Application Root Replica with a Proxy PDB"](#)

## 10.1.1 Proxy PDBs and SQL Statements

As a rule, when the proxy PDB is the current container, SQL statements submitted for execution in the proxy PDB are executed in the referenced PDB.

The results of the remote execution are returned to the proxy PDB. For example, data definition language (DDL) statements, data manipulation language (DML) statements, and queries executed in the proxy PDB are sent to the referenced PDB for execution, and the results are returned to the proxy PDB.

There is one exception to the rule. When the proxy PDB is the current container, and when you execute `ALTER PLUGGABLE DATABASE` and `ALTER DATABASE` statements, these statements only affect the proxy PDB. They are not sent to the referenced PDB for execution. Similarly, when the current container is the root to which the proxy PDB belongs, `ALTER PLUGGABLE DATABASE` statements only affect the proxy PDB. For example, an `ALTER PLUGGABLE DATABASE` statement executed in a CDB root, application root, or proxy PDB can open or close a proxy PDB, but this statement does not open or close the referenced PDB.

## 10.1.2 Proxy PDBs and Database Links

A database link is required when you create a proxy PDB.

After the proxy PDB is created, the database link specified during creation is no longer used by the proxy PDB. Instead, the proxy PDB communicates directly with the referenced PDB.

This direct communication requires the port number and host name of the listener of the CDB that contains the referenced PDB. During proxy PDB creation, the proxy PDB uses the following values by default:

- **Listener port number:** 1521

If the referenced PDB's listener does not use the default port number, then you must use the `PORT` clause to specify the listener's port number. You can specify the port number when you create the proxy PDB, or you can alter the proxy PDB to change the port number.

- **Listener host name:** The host name of the CDB that contains the referenced PDB

If the referenced PDB's listener does not use the default host name, then you must use the `HOST` clause to specify the listener's host name. You can specify the host name when you create the proxy PDB, or you can alter the proxy PDB to change the host name.

#### Related Topics

- [Proxy PDBs and the Listener](#)  
The host name and port number settings for a PDB are important only if proxy PDBs will reference the PDB.
- [Modifying the Listener Settings of a Referenced PDB](#)  
A PDB that is referenced by a proxy PDB is called a referenced PDB.

## 10.1.3 Proxy PDBs and Authentication

Only password authentication is supported for sessions in a proxy PDB.

## 10.1.4 Proxy PDBs and the Listener

The host name and port number settings for a PDB are important only if proxy PDBs will reference the PDB.

This section contains the following topics:

- [HOST Clause](#)  
The `HOST` clause of the `CREATE PLUGGABLE DATABASE` statement specifies the host name of the listener for the PDB being created.
- [PORT Clause](#)  
The `PORT` clause of the `CREATE PLUGGABLE DATABASE` statement specifies the port number of the listener for the PDB being created.

### 10.1.4.1 HOST Clause

The `HOST` clause of the `CREATE PLUGGABLE DATABASE` statement specifies the host name of the listener for the PDB being created.

By default, the host name of the listener is the same as the host name of the PDB being created. Specify the `HOST` clause when both of the following conditions are true:

- The host name of the listener is different from the host name of the PDB being created.
- You plan to create proxy PDBs that reference the PDB being created.

A proxy PDB uses a database link to establish communication with its referenced PDB. After communication is established, the proxy PDB communicates directly with the referenced PDB without using a database link. The host name of the listener must be correct for the proxy PDB to function properly.

#### Example 10-1 HOST Clause

```
HOST='myhost.example.com'
```

#### See Also:

- ["About Creating a Proxy PDB"](#)
- ["Altering the Listener Host Name of a Referenced PDB"](#)
- *Oracle Database SQL Language Reference* to learn more about the HOST clause

### 10.1.4.2 PORT Clause

The PORT clause of the CREATE PLUGGABLE DATABASE statement specifies the port number of the listener for the PDB being created.

By default, the port number of the listener for the PDB being created is 1521. Specify the PORT clause when both of the following conditions are true:

- The port number of the listener is not 1521.
- You plan to create proxy PDBs that reference the PDB being created.

A proxy PDB uses a database link to establish communication with its referenced PDB. After communication is established, the proxy PDB communicates directly with the referenced PDB without using a database link. The port number of the listener must be correct for the proxy PDB to function properly.

#### Example 10-2 PORT Clause

```
PORT=1599
```

#### Note:

- ["About Creating a Proxy PDB"](#)
- ["Altering the Listener Host Name of a Referenced PDB"](#)
- *Oracle Database SQL Language Reference* to learn more about the PORT clause

## 10.2 Creating a Proxy PDB

Create a proxy PDB by referencing a PDB in a different CDB.

### Prerequisites

The following prerequisites must be met:

- Complete the prerequisites described in "[General Prerequisites for PDB Creation](#)".
- The current user must have the `CREATE PLUGGABLE DATABASE` system privilege in the root of the CDB in which the proxy PDB is being created.
- The CDB that contains the referenced PDB must be in local undo mode.
- The CDB that contains the referenced PDB must be in `ARCHIVELOG` mode.
- The referenced PDB must be in open read/write mode when the proxy PDB is created. The open mode of the referenced PDB can be changed after the proxy PDB is created.
- A database link must enable a connection from the root of the CDB in which the proxy PDB is being created to the location of the referenced PDB. The database link can connect to either the root of the remote CDB or to the remote PDB.
- If the database link connects to the root in a remote CDB that contains the referenced PDB, then the user that the database link connects with must be a common user.
- If the database link connects to the referenced PDB, then the user that the database link connects with in the referenced PDB must have the `CREATE PLUGGABLE DATABASE` system privilege.
- If you are creating a proxy PDB in an application container, then the following prerequisites apply:
  - The referenced PDB must be an application root or an application PDB in an application container.
  - The application name and version of the proxy PDB's application container must match the application name and version of the referenced PDB.
  - When the proxy PDB is being created in an application container, a database link must enable a connection from the root of the application container in which the proxy PDB is being created to the location of the referenced PDB. The database link can connect to either the root of the remote application container or to the remote application PDB.
  - If the database link connects to the root in a remote application container that contains the referenced PDB, then the user that the database link connects with must be an application common user.
  - If the database link connects to the referenced application PDB, then the user that the database link connects with in the referenced application PDB must have the `CREATE PLUGGABLE DATABASE` system privilege.

 **Note:**

You can create a proxy PDB in a CDB root that is based on a referenced PDB in an application container.

**To create a proxy PDB:**

1. In SQL\*Plus, ensure that the current container is the CDB root or application root in which the proxy PDB is being created.

When the current container is the CDB root, the proxy PDB is created in the CDB. When the current container is an application root, the proxy PDB is created in the application container.

2. Run the `CREATE PLUGGABLE DATABASE` statement. Specify the `AS PROXY` clause, and specify the referenced PDB with the database link name in the `FROM` clause. Specify other clauses when they are required.

After you create the proxy PDB, it is in mounted mode, and its status is `NEW`. You can view the open mode of a PDB by querying the `OPEN_MODE` column in the `V$PDBS` view. You can view the status of a PDB by querying the `STATUS` column of the `CDB_PDBS` or `DBA_PDBS` view.

A new default service is created for the PDB. The service has the same name as the PDB and can be used to access the PDB. Oracle Net Services must be configured properly for clients to access this service.

3. Open the new PDB in read/write mode.

You must open the new PDB in read/write mode for Oracle Database to complete the integration of the new PDB into the CDB. An error is returned if you attempt to open the PDB in read-only mode. After the PDB is opened in read/write mode, its status is `NORMAL`.

4. Back up the PDB.

A PDB cannot be recovered unless it is backed up.

 **Note:**

If an error is returned during creation of the proxy PDB, then the PDB being created might be in an `UNUSABLE` state. You can check a PDB's state by querying the `CDB_PDBS` or `DBA_PDBS` view, and you can learn more about PDB creation errors by checking the alert log. An unusable PDB can only be dropped, and it must be dropped before a PDB with the same name as the unusable PDB can be created.

**Example 10-3 Creating a Remote Proxy PDB**

In this example, the root to which the new PDB belongs depends on the current container when the `CREATE PLUGGABLE DATABASE` statement is run:

- When the current container is the CDB root, the new PDB is created in the CDB root.

- When the current container is an application root in an application container, the new PDB is created as an application PDB in the application root.

This example creates a remote proxy PDB named `pdb1` given different factors. This example assumes the following factors:

- The database link name to the referenced PDB's CDB is `pdb1_link`.
- The `FILE_NAME_CONVERT` clause and the `CREATE_FILE_DEST` clause are not required.

Either Oracle Managed Files is enabled, or the `PDB_FILE_NAME_CONVERT` initialization parameter is set. The `SYSTEM` and `SYSAUX` files will be copied to a new location based on the Oracle Managed Files configuration or the initialization parameter setting.

Given the preceding factors, the following statement creates the `pdb1` proxy PDB:

```
CREATE PLUGGABLE DATABASE pdb1 AS PROXY FROM pdb1@pdb1_link;
```

#### See Also:

- ["About the CDB Undo Mode"](#)
- ["About Container Access in a CDB"](#)
- ["Modifying the Open Mode of One or More PDBs"](#)
- *Oracle Database Backup and Recovery User's Guide* for information about backing up a PDB



# 11

## Removing a PDB

You can remove a plugged-in PDB from a CDB by unplugging it, dropping it, or relocating it.

This chapter contains the following topics:

- [Unplugging a PDB from a CDB](#)  
Just as you can plug a PDB into a CDB, you can unplug a PDB from a CDB.
- [Dropping a PDB](#)  
Drop a PDB when you want to move the PDB to a new CDB or when you no longer need it.



### See Also:

["Relocating a PDB"](#)

## 11.1 Unplugging a PDB from a CDB

Just as you can plug a PDB into a CDB, you can unplug a PDB from a CDB.

This section contains the following topics:

- [About Unplugging a PDB](#)  
Unplugging a PDB disassociates the PDB from a CDB. A PDB is usable only when it is plugged into a CDB.
- [Unplugging a PDB](#)  
Unplug a PDB with a `ALTER PLUGGABLE DATABASE ... UNPLUG INTO` statement.

### 11.1.1 About Unplugging a PDB

Unplugging a PDB disassociates the PDB from a CDB. A PDB is usable only when it is plugged into a CDB.

Unplug a PDB when you want to do any of the following:

- Move the PDB to a different CDB
- Archive the PDB for later use
- Make the PDB unavailable for use

To unplug a PDB, connect to its CDB root or application root and use the `ALTER PLUGGABLE DATABASE` statement to specify either of the following:

- XML file

An XML file (.xml extension) contains metadata about the PDB after it is unplugged. This metadata contains the required information to enable a `CREATE PLUGGABLE DATABASE` statement on a target CDB to plug in the PDB.

- .pdb file

A .pdb file contains a compressed archive of the XML file that describes the PDB and the files used by the PDB (such as the data files and wallet file). A .pdb file enables you to copy a single, compressed file (instead of multiple files) to a new location to plug the PDB into a CDB.

**Figure 11-1 Unplug a PDB**

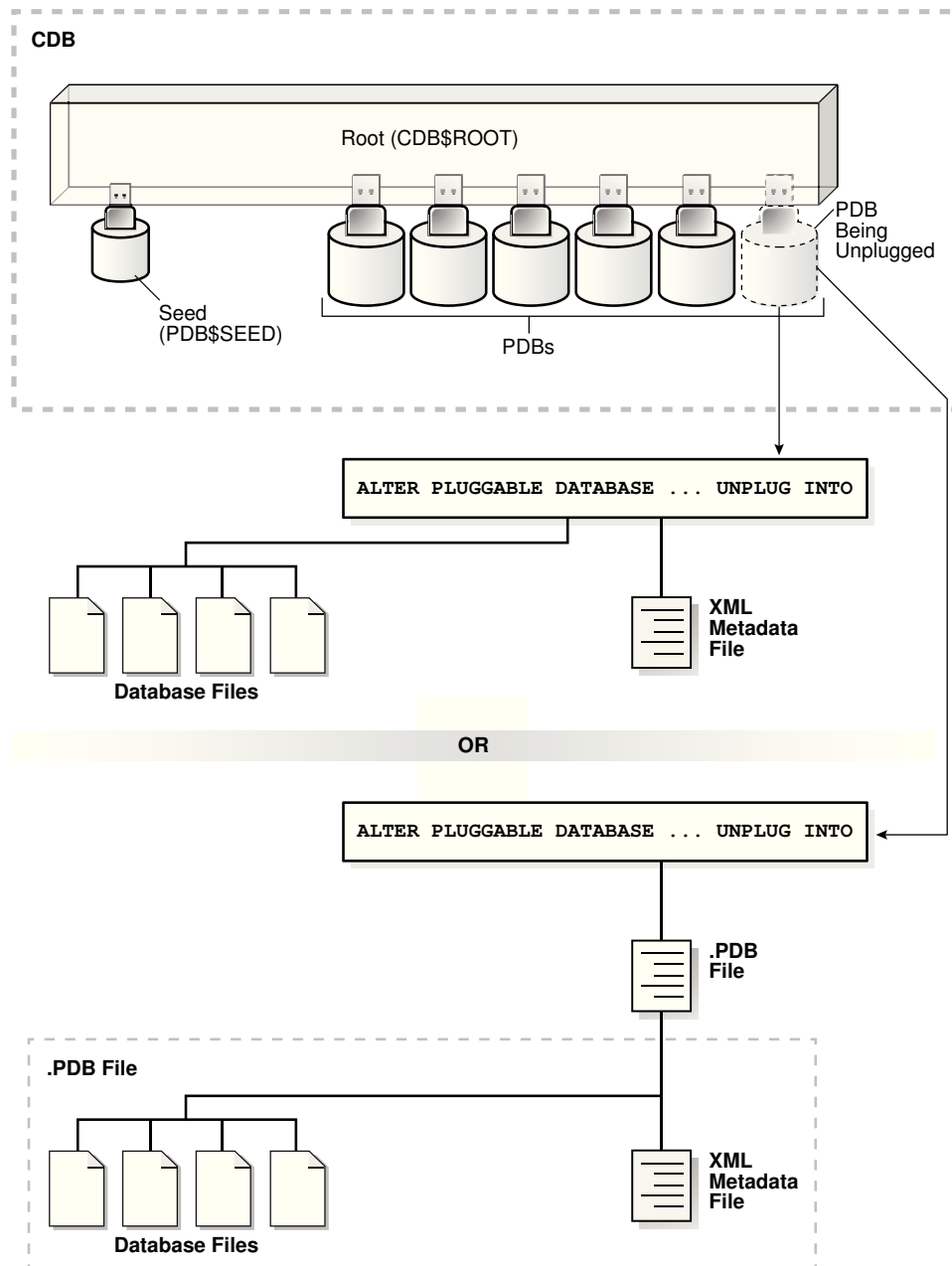

The following illustration shows how this technique unplugs an application PDB from an application container.

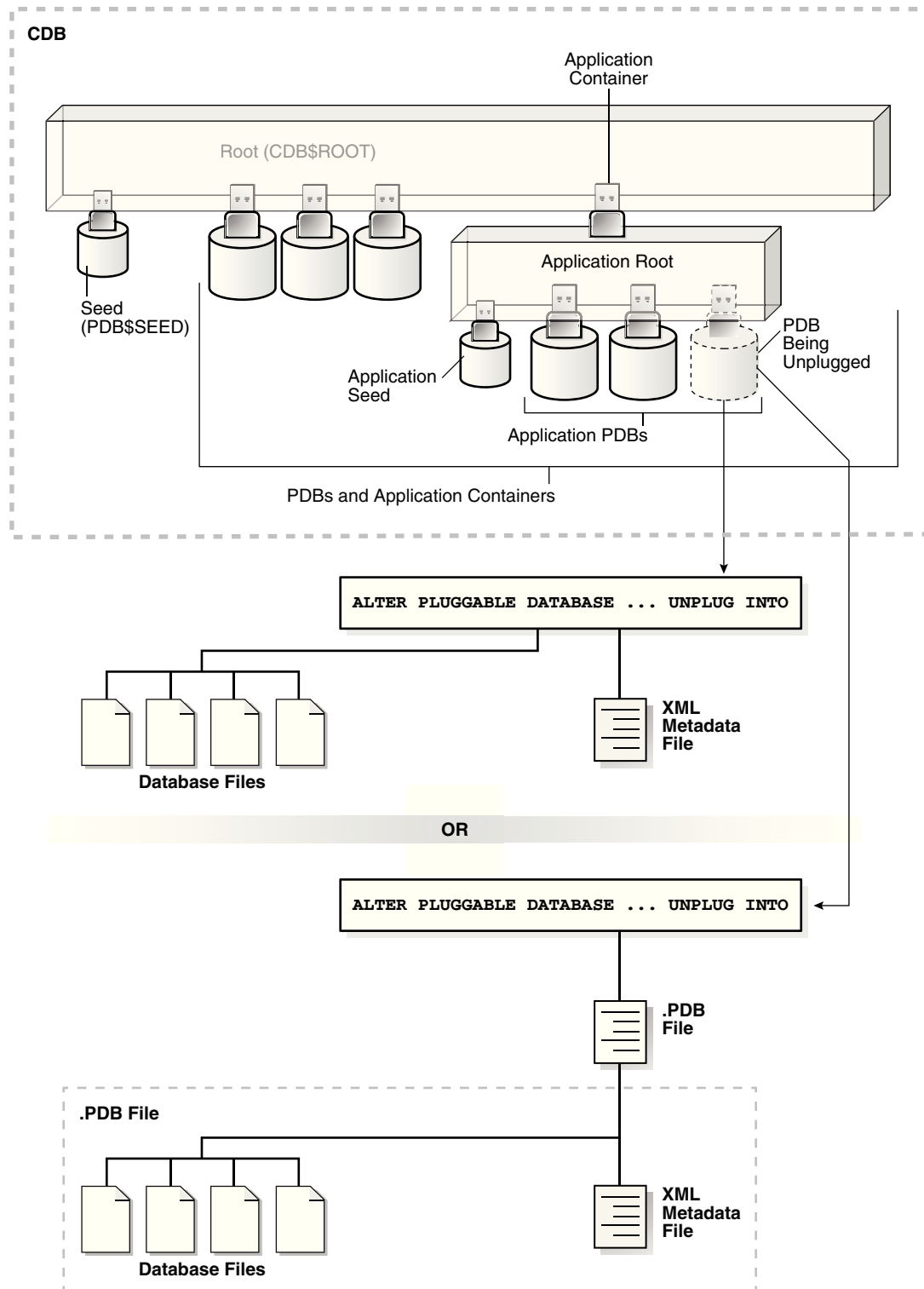

The PDB must be closed before it can be unplugged. When you unplug a PDB, the unplugged PDB is in mounted mode. The unplug operation makes some changes in the PDB's data files to record, for example, that the PDB was successfully unplugged. Because it is still part of the CDB, the unplugged PDB is included in an RMAN backup of the entire CDB. Such a backup provides a convenient way to archive the unplugged PDB in case it is needed in the future.

To completely remove the PDB from the CDB, drop the PDB. The only operation supported on an unplugged PDB is dropping the PDB. The PDB must be dropped from the CDB before it can be plugged back into the same CDB.

 **Note:**

You can unplug an application container only if no application PDBs belong to it.

 **See Also:**

- ["Dropping a PDB"](#)
- ["Modifying the Open Mode of One or More PDBs"](#) for information about closing a PDB
- ["Modifying a PDB at the System Level"](#) for information about initialization parameters and unplugged PDBs
- *Oracle Database Security Guide* for information about common users and local users

## 11.1.2 Unplugging a PDB

Unplug a PDB with a `ALTER PLUGGABLE DATABASE ... UNPLUG INTO` statement.

### Prerequisites

The following prerequisites must be met:

- The current user must have `SYSDBA` or `SYSOPER` administrative privilege, and the privilege must be either commonly granted or locally granted in the PDB. The user must exercise the privilege using `AS SYSDBA` or `AS SYSOPER` at connect time.
- The PDB must have been opened at least once.

 **Note:**

If you are unplugging a PDB that includes data that was encrypted with Transparent Data Encryption, then follow the instructions in *Oracle Database Advanced Security Guide*.

**To unplug a PDB:**

1. In SQL\*Plus, ensure that the current container is the root of the PDB.

If the PDB is plugged into the CDB root, then the current container must be the CDB root. If the PDB is plugged into an application root, then the current container must be the application root.

If you are unplugging an application container, then the current container must be the CDB root, and the application container must not have any application PDBs plugged into it.

2. Close the PDB.

In an Oracle Real Application Clusters (Oracle RAC) environment, the PDB must be closed on all instances.

3. Run the `ALTER PLUGGABLE DATABASE` statement with the `UNPLUG INTO` clause, and specify the PDB to unplug and the name and location of the PDB's XML metadata file or `.pdb` file.

**Example 11-1 Unplugging PDB salespdb Into an XML Metadata File**

This `ALTER PLUGGABLE DATABASE` statement unplugs the PDB `salespdb` and creates the `salespdb.xml` metadata file in the `/oracle/data/` directory:

```
ALTER PLUGGABLE DATABASE salespdb UNPLUG INTO '/oracle/data/salespdb.xml';
```

**Example 11-2 Unplugging PDB salespdb Into an Archive File**

This `ALTER PLUGGABLE DATABASE` statement unplugs the PDB `salespdb` and creates the `sales.pdb` archive file in the `/oracle/data/` directory. The `sales.pdb` archive file is a compressed file that includes the XML metadata file and the PDB's files (such as the data files and wallet file).

```
ALTER PLUGGABLE DATABASE salespdb UNPLUG INTO '/oracle/data/sales.pdb';
```

## 11.2 Dropping a PDB

Drop a PDB when you want to move the PDB to a new CDB or when you no longer need it.

When you drop a PDB, the control file of the CDB is modified to eliminate all references to the dropped PDB. Archived redo log files and backups associated with the PDB are not removed, but you can use Oracle Recovery Manager (RMAN) to remove them.

When dropping a PDB, you can either keep or delete the PDB's data files by using one of the following clauses of the `DROP PLUGGABLE DATABASE` statement:

- `KEEP DATAFILES`, the default, retains the data files.

The PDB temp file is removed even when `KEEP DATAFILES` is specified because the temp file is no longer needed.

When `KEEP DATAFILES` is specified, the PDB must be unplugged.

- `INCLUDING DATAFILES` removes the data files from disk.

If a PDB was created with the `SNAPSHOT COPY` clause, then you must specify `INCLUDING DATAFILES` when you drop the PDB.

### Prerequisites

The following prerequisites must be met:

- The PDB must be in mounted mode, or it must be unplugged.  
See "[Modifying the Open Mode of One or More PDBs](#)".  
See "[Unplugging a PDB from a CDB](#)".
- The current user must have `SYSDBA` or `SYSOPER` administrative privilege, and the privilege must be either commonly granted or locally granted in the PDB. The user must exercise the privilege using `AS SYSDBA` or `AS SYSOPER` at connect time.



#### Note:

This operation is destructive.

### To drop a PDB:

1. In SQL\*Plus, ensure that the current container is the CDB root, or, for an application PDB, the application root that contains the application PDB.  
  
If the PDB is plugged into the CDB root, then the current container must be the CDB root. If the PDB is plugged into an application root, then the current container must be that application root or the CDB root.  
  
If you are dropping an application container, then the current container must be the CDB root, and the application container must not have any application PDBs plugged into it.
2. Run the `DROP PLUGGABLE DATABASE` statement and specify the PDB to drop.

#### Example 11-3 Dropping PDB salespdb While Keeping Its Data Files

```
DROP PLUGGABLE DATABASE salespdb  
KEEP DATAFILES;
```

#### Example 11-4 Dropping PDB salespdb and Its Data Files

```
DROP PLUGGABLE DATABASE salespdb  
INCLUDING DATAFILES;
```

 **See Also:**

- ["Unplugging a PDB from a CDB"](#)
- ["Storage Requirements for Snapshot Copy PDBs"](#)
- *Oracle Database SQL Language Reference*
- *Oracle Database Backup and Recovery User's Guide* for information about RMAN

# 12

## Creating and Removing Application Containers and Seeds

You can create application containers and application seeds in several different ways. You can also remove application containers from a CDB, and you can remove application seeds from application containers.

This section contains the following topics:

- [Creating and Removing Application Containers](#)  
You can create application containers in several different ways, including using the PDB seed, cloning an existing PDB or non-CDB, and plugging in an unplugged PDB. You can also remove application containers from a CDB.
- [Creating and Removing Application Seeds](#)  
You can create application seeds in several different ways, including using the PDB seed, cloning an existing PDB or non-CDB, and plugging in an unplugged PDB. You can also remove application seeds from application containers.
- [Creating an Application PDB](#)  
You create an application PDB by running the `CREATE PLUGGABLE DATABASE` statement with an application root as the current container.

### See Also:

- ["About Application Containers"](#)
- ["Administering Application Containers"](#)

### 12.1 Creating and Removing Application Containers

You can create application containers in several different ways, including using the PDB seed, cloning an existing PDB or non-CDB, and plugging in an unplugged PDB. You can also remove application containers from a CDB.

This section contains the following topics:

- [Creating Application Containers](#)  
You can use the `CREATE PLUGGABLE DATABASE` statement to create an application container in a CDB.
- [Unplugging an Application Container from a CDB](#)  
You can unplug an application container from a CDB.



- [Dropping an Application Container](#)  
You can drop an application container when you want to move the application container from one CDB to another or when you no longer need the application container.

## 12.1.1 Creating Application Containers

You can use the `CREATE PLUGGABLE DATABASE` statement to create an application container in a CDB.

This section contains the following topics:

- [About Creating an Application Container](#)  
The `CREATE PLUGGABLE DATABASE ... AS APPLICATION CONTAINER` statement creates a new application container.
- [Preparing for Application Containers](#)  
Prerequisites must be met before creating an application container.
- [Creating an Application Container](#)  
You can create an application container using the `CREATE PLUGGABLE DATABASE` statement with the `AS APPLICATION CONTAINER` clause.

### 12.1.1.1 About Creating an Application Container

The `CREATE PLUGGABLE DATABASE ... AS APPLICATION CONTAINER` statement creates a new application container.

An application container consists of an application root and a collection of application PDBs that store data for one or more applications. The application PDBs are plugged into the application root, and you can optionally create an application seed for quick and easy creation of new application PDBs. The application PDBs and application root can share application common objects.

There are three types of application common objects:

- Metadata-linked application common objects store the metadata for specific objects, such as tables, so that the containers that share the application common object have the same structure but different data.
- Data-linked application common objects are defined once in the application root and shared as read-only objects in the context of hosted application PDBs.
- Extended data-linked application common objects store shared data in the application root but also allow application PDBs to store data appended to that object. The appended data is local data that is unique to each application PDB.

You create an application container by including the `AS APPLICATION CONTAINER` clause in the `CREATE PLUGGABLE DATABASE` statement. You can use the following techniques to create an application container:

- Using the PDB seed
- Cloning an existing PDB or non-CDB
- Relocating a PDB
- Plugging in an unplugged PDB

To create an application container, the current container must be the CDB root and you must specify the `AS APPLICATION CONTAINER` clause in

the `CREATE PLUGGABLE DATABASE` statement. You must create the application container using Oracle Managed Files.

 **Note:**

An application container cannot be unplugged or dropped if any application PDBs belong to it.

### Migrating Existing Applications to an Application Container

You can migrate an application to an application root by creating an application root using an existing PDB. You must complete additional tasks when you are migrating an existing application to an application container. The PDBs that you plug in must contain the application objects, including their data, and you must run procedures in the `DBMS_PDB` package to specify which objects are shared. Also, when application common users, roles, or profiles exist in the application root, you must run procedures in the `DBMS_PDB` package to specify that they are common.

After the application is migrated to the application root, you can create application PDBs in the application root, and create application PDBs using existing PDBs.

 **See Also:**

["Migrating an Existing Application to an Application Container"](#)

## 12.1.1.2 Preparing for Application Containers

Prerequisites must be met before creating an application container.

- The CDB must exist.
- The CDB must be in read/write mode.
- The current user must be a common user whose current container is the CDB root.
- The current user must have the `CREATE PLUGGABLE DATABASE` system privilege.
- You must decide on a unique application container name for every application container. Every application container name must be unique with respect to all containers in a single CDB, and every application container name must be unique within the scope of all the CDBs whose database instances are reached through a specific listener.

The application container name is used to distinguish an application container from other containers in the CDB. Application container names follow the same rules as service names, which includes being case-insensitive.

- You must create the containing using Oracle Managed Files.
- If you are creating an application container in an Oracle Data Guard configuration with a physical standby database, then additional tasks must be completed before creating an application container.

- If you are migrating an existing application to an application container using installation scripts, then the scripts must be available to run.
- If you are migrating an existing application to an application container using a PDB, then it must be possible to clone the PDB to the application root or plug in the PDB into the application root.

 **See Also:**

- ["About the Current Container"](#)
- ["Migrating an Existing Application to an Application Container"](#)
- *Oracle Data Guard Concepts and Administration*

### 12.1.1.3 Creating an Application Container

You can create an application container using the `CREATE PLUGGABLE DATABASE` statement with the `AS APPLICATION CONTAINER` clause.

Before creating an application container, complete the prerequisites described in ["Preparing for Application Containers"](#).

1. In SQL\*Plus, ensure that the current container is the CDB root.
2. Run the `CREATE PLUGGABLE DATABASE` statement, and include the `AS APPLICATION CONTAINER` clause. Specify other clauses when they are required.

After you create the application container, it is in mounted mode, and its status is `NEW`. You can view the open mode of an application container by querying the `OPEN_MODE` column in the `V$PDBS` view. You can view the status of an application container by querying the `STATUS` column of the `CDB_PDBS` or `DEA_PDBS` view.

A new default service is created for the application container. The service has the same name as the application container and can be used to access the application container. Oracle Net Services must be configured properly for clients to access this service.

3. Open the new application container in read/write mode.

You must open the new application container in read/write mode for Oracle Database to complete the integration of the new application container into the CDB. An error is returned if you attempt to open the application container in read-only mode. After the application container is opened in read/write mode, its status is `NORMAL`.

4. Back up the application container.

A application container cannot be recovered unless it is backed up.

 **Note:**

If an error is returned during application container creation, then the application container being created might be in an `UNUSABLE` state. You can check an application container's state by querying the `CDB_PDBS` or `DBA_PDBS` view, and you can learn more about application container creation errors by checking the alert log. An unusable application container can only be dropped, and it must be dropped before an application container or PDB with the same name as the unusable application container can be created.

5. If you are migrating an existing application to the application container, then follow the instructions in "[Migrating an Existing Application to an Application Container](#)".

The application container is created with an application root. You can create application PDBs in the application container.

**Example 12-1 Creating an Application Container Using the PDB seed**

This example assumes the following factors:

- Storage limits are not required for the application container. Therefore, the `STORAGE` clause is not required.
- The application container does not require a default tablespace.
- The `PATH_PREFIX` clause is not required.
- The `FILE_NAME_CONVERT` clause and the `CREATE_FILE_DEST` clause are not required.

Either Oracle Managed Files is enabled for the CDB, or the `PDB_FILE_NAME_CONVERT` initialization parameter is set. The files associated with the PDB seed will be copied to a new location based on the Oracle Managed Files configuration or the initialization parameter setting.

- There is no file with the same name as the new temp file that will be created in the target location. Therefore, the `TEMPFILE REUSE` clause is not required.
- No predefined Oracle roles need to be granted to the `PDB_DBA` role.

The following statement creates the application container from the PDB seed:

```
CREATE PLUGGABLE DATABASE salesact AS APPLICATION CONTAINER
  ADMIN USER salesadm IDENTIFIED BY password;
```

**Example 12-2 Creating an Application Container by Cloning a Local PDB**

This example assumes the following factors:

- The `PATH_PREFIX` clause is not required.
- The `FILE_NAME_CONVERT` clause is required to specify the target locations of the copied files. In this example, the files are copied from `/disk1/oracle/pdb1/` to `/disk2/oracle/hract/`.

The `CREATE_FILE_DEST` clause is not used, and neither Oracle Managed Files nor the `PDB_FILE_NAME_CONVERT` initialization parameter is used to specify the target locations of the copied files.

To view the location of the data files for a PDB, run the query in "Example 19-7".

- Storage limits must be enforced for the application root. Therefore, the `STORAGE` clause is required. Specifically, all tablespaces that belong to the application root must not exceed 2 gigabytes. This storage limit does not apply to the application PDBs that are plugged into the application root.
- There is no file with the same name as the new temp file that will be created in the target location. Therefore, the `TEMPFILE REUSE` clause is not required.

Given the preceding factors, the following statement clones `hract` as an application container from `pdb1`:

```
CREATE PLUGGABLE DATABASE hract AS APPLICATION CONTAINER FROM pdb1
  FILE_NAME_CONVERT = ('/disk1/oracle/pdb1/', '/disk2/oracle/hract/')
  STORAGE (MAXSIZE 2G);
```

 **Note:**

If you are migrating an existing application to the new application container, then follow the instructions in "[Migrating an Existing Application to an Application Container](#)".

### Example 12-3 Creating an Application Container by Plugging In an Unplugged PDB

This example assumes the following factors:

- The new application container is not based on the same unplugged PDB that was used to create an existing PDB or application container in the CDB. Therefore, the `AS CLONE` clause is not required.
- The `PATH_PREFIX` clause is not required.
- The XML file does not accurately describe the current locations of the files. Therefore, the `SOURCE_FILE_NAME_CONVERT` clause or `SOURCE_FILE_DIRECTORY` clause is required. In this example, the XML file indicates that the files are in `/disk1/oracle/payroll/`, but the files are in `/disk2/oracle/payroll/`, and the `SOURCE_FILE_NAME_CONVERT` clause is used.
- The files are in the correct location. Therefore, `NOCOPY` is included.
- Storage limits must be enforced for the application container. Therefore, the `STORAGE` clause is required. Specifically, all tablespaces that belong to the application container must not exceed 2 gigabytes.
- A file with the same name as the temp file specified in the XML file exists in the target location. Therefore, the `TEMPFILE REUSE` clause is required.

The following statement plugs in the PDB:

```
CREATE PLUGGABLE DATABASE payrollact AS APPLICATION CONTAINER USING '/
disk1/usr/payrollpdb.xml'
  SOURCE_FILE_NAME_CONVERT = ('/disk1/oracle/payroll/', '/disk2/oracle/
payroll/')
  NOCOPY
```

```
STORAGE (MAXSIZE 2G)
TEMPFILE REUSE;
```

 **Note:**

If you are migrating an existing application to the new application container, then follow the instructions in "[Migrating an Existing Application to an Application Container](#)".

**Related Topics**

- [About the Current Container](#)  
The data dictionary in each container in a CDB is separate, and the current container is the container whose data dictionary is used for name resolution and for privilege authorization.
- [Administering Application Containers](#)  
You can administer application containers, including application roots and application PDBs. You can also administer the applications installed in application containers.
- [Accessing a Container in a CDB](#)  
Access a container in a CDB with SQL\*Plus by issuing a `CONNECT` or `ALTER SESSION` command.
- [Modifying the Open Mode of One or More PDBs](#)  
You can modify the open mode of a PDB by using the `ALTER PLUGGABLE DATABASE` SQL statement or the SQL\*Plus `STARTUP` command.

## 12.1.2 Unplugging an Application Container from a CDB

You can unplug an application container from a CDB.

This section contains the following topics:

- [About Unplugging an Application Container](#)  
Unplugging an application container disassociates the application container from a CDB.
- [Unplugging an Application Container](#)  
Unplug an application container by using an `ALTER PLUGGABLE DATABASE ... UNPLUG INTO` statement.

### 12.1.2.1 About Unplugging an Application Container

Unplugging an application container disassociates the application container from a CDB.

Typically, you unplug an application container when you want to move the application container to a different CDB. Also, you can unplug the application container when you no longer want it to be available.

Unplugging an application container is similar to unplugging a PDB. To unplug an application container, connect to its CDB root and use the `ALTER PLUGGABLE DATABASE` statement to specify an XML file or a `.pdb` file. When you specify an XML file (`.xml`

extension), it will contain metadata about the application container after it is unplugged. The SQL statement creates the XML file, and it contains the required information to enable a `CREATE PLUGGABLE DATABASE` statement on a target CDB to plug in the application container. When you specify a `.pdb` file, it contains a compressed archive of the XML file that describes the application container and the files used by the application container (such as the data files and wallet file). A `.pdb` file enables you to copy a single, compressed file (instead of multiple files) to a new location to plug the application container into a CDB.

Before it can be unplugged, the application container must not have any application PDBs plugged into it, and it must be closed. When you unplug an application container, the unplugged application container is in mounted mode. The unplug operation makes some changes in the application container's data files to record, for example, that the application container was successfully unplugged. Because it is still part of the CDB, the unplugged application container is included in an RMAN backup of the entire CDB. Such a backup provides a convenient way to archive the unplugged application container in case it is needed in the future.

To completely remove the application container from the CDB, you can drop it. The only operation supported on an unplugged application container is dropping the application container. The application container must be dropped from the CDB before it can be plugged back into the same CDB. An application container is usable only when it is plugged into a CDB.



#### See Also:

- ["Unplugging a PDB from a CDB"](#)
- ["Dropping an Application Container"](#)
- ["Modifying the Open Mode of One or More PDBs"](#) for information about closing a PDB
- ["Modifying a PDB at the System Level"](#) for information about initialization parameters and unplugged PDBs
- *Oracle Database Security Guide* for information about common users and local users

## 12.1.2.2 Unplugging an Application Container

Unplug an application container by using an `ALTER PLUGGABLE DATABASE ... UNPLUG INTO` statement.

### Prerequisites

You must meet the following prerequisites:

- The current user must have `SYSDBA` or `SYSOPER` administrative privilege, and the privilege must be either commonly granted or locally granted in the PDB. The user must exercise the privilege using `AS SYSDBA` or `AS SYSOPER` at connect time.
- The application container must have been opened at least once.
- The application container must not have any application PDBs plugged into it.

- The application container must not have an application seed plugged into it.

 **Note:**

If you are unplugging an application container that includes data that was encrypted with Transparent Data Encryption, then follow the instructions in *Oracle Database Advanced Security Guide*.

**To unplug an application container:**

1. In SQL\*Plus, ensure that the current container is the root of the CDB.
2. Close the application container.  
In an Oracle Real Application Clusters (Oracle RAC) environment, the application container must be closed on all instances.
3. Run the `ALTER PLUGGABLE DATABASE` statement with the `UNPLUG INTO` clause, and specify the application container to unplug and the name and location of the application container's XML metadata file or `.pdb` file.

**Example 12-4 Unplugging Application Container salesact**

This `ALTER PLUGGABLE DATABASE` statement unplugs the application container `salesact` and creates the `salesact.xml` metadata file in the `/oracle/data/` directory:

```
ALTER PLUGGABLE DATABASE salesact UNPLUG INTO '/oracle/data/saleact.xml';
```

## 12.1.3 Dropping an Application Container

You can drop an application container when you want to move the application container from one CDB to another or when you no longer need the application container.

Dropping an application container is very similar to dropping a PDB. When you drop an application container, the control file of the CDB is modified to eliminate all references to the dropped application container. Archived redo log files and backups associated with the application container are not removed, but you can use Oracle Recovery Manager (RMAN) to remove them.

When dropping an application container, you can either keep or delete the application container's data files by using one of the following clauses in the `DROP PLUGGABLE DATABASE` statement:

- `KEEP DATAFILES`, the default, retains the data files.  
The application container's temp file is removed even when `KEEP DATAFILES` is specified because the temp file is no longer needed.

- `INCLUDING DATAFILES` removes the data files from disk.

If an application container was created with the `SNAPSHOT COPY` clause, then you must specify `INCLUDING DATAFILES` when you drop the application container.

The following prerequisites must be met:



- The application container must be in mounted mode, or it must be unplugged.  
See "[Modifying the Open Mode of One or More PDBs](#)".  
See "[Unplugging an Application Container](#)".
- The current user must have SYSDBA or SYSOPER administrative privilege, and the privilege must be either commonly granted or locally granted in the application container. The user must exercise the privilege using AS SYSDBA or AS SYSOPER at connect time.
- The application container must not have any application PDBs plugged into it.
- The application container must not have an application seed plugged into it.



#### Note:

This operation is destructive.

#### To drop an application container:

1. In SQL\*Plus, ensure that the current container is the CDB root.  
See "[About the Current Container](#)" and "[Accessing a Container in a CDB with SQL\\*Plus](#)".
2. Run the DROP PLUGGABLE DATABASE statement and specify the application container to drop.

#### Example 12-5 Dropping Application Container salesact While Keeping Its Data Files

```
DROP PLUGGABLE DATABASE salesact
KEEP DATAFILES;
```

#### Example 12-6 Dropping Application Container salesact and Its Data Files

```
DROP PLUGGABLE DATABASE saleact
INCLUDING DATAFILES;
```



#### See Also:

- "[Unplugging an Application Container](#)"
- "[Dropping a PDB](#)"
- "[Storage Requirements for Snapshot Copy PDBs](#)"
- *Oracle Database SQL Language Reference*
- i  
*Oracle Database Backup and Recovery User's Guide* for information about RMAN

## 12.2 Creating and Removing Application Seeds

You can create application seeds in several different ways, including using the PDB seed, cloning an existing PDB or non-CDB, and plugging in an unplugged PDB. You can also remove application seeds from application containers.

This section contains the following topics:

- [Creating Application Seeds](#)  
You can use the `CREATE PLUGGABLE DATABASE` statement to create an application seed in an application container.
- [Unplugging an Application Seed from an Application Container](#)  
You can unplug an application seed from an application container.
- [Dropping an Application Seed](#)  
You can use the `DROP PLUGGABLE DATABASE` statement to drop an application seed. You can drop an application seed when you no longer need it.

### 12.2.1 Creating Application Seeds

You can use the `CREATE PLUGGABLE DATABASE` statement to create an application seed in an application container.

This section contains the following topics:

- [About Creating an Application Seed](#)  
To create a new application seed in an application container, use the `CREATE PLUGGABLE DATABASE` statement with the `AS SEED` clause.
- [Preparing for an Application Seed](#)  
Prerequisites must be met before creating an application seed.
- [Creating an Application Seed](#)  
You create an application seed by including the `AS SEED` clause in the `CREATE PLUGGABLE DATABASE` statement.

#### 12.2.1.1 About Creating an Application Seed

To create a new application seed in an application container, use the `CREATE PLUGGABLE DATABASE` statement with the `AS SEED` clause.

You can use an application seed to provision an application container with application PDBs that have the application root's applications installed. Typically, the application container's applications are installed in the application root before seed creation. After the application seed is created, it is synchronized with the application root so that the applications are installed in the application seed. When that is complete, any PDBs created using the application seed have the applications installed. When an application in the application root is upgraded or patched, the application seed must be synchronized with the application root to apply these changes.

An application container can have zero or one application seeds. When you create an application seed using the `AS SEED` clause of `CREATE PLUGGABLE DATABASE`, you do not specify its name. The application seed name is always `application_container_name$SEED`, where `application_container_name` is the

name of the application seed's application container. For example, an application seed in the `salesact` application container must be named `salesact$SEED`.

When you create a new application seed, you must specify an administrator for the application container in the `CREATE PLUGGABLE DATABASE` statement. The statement creates the administrator as a local user in the application container and grants the `PDB_DBA` role locally to the administrator.

 **See Also:**

- ["Creating a PDB from Scratch"](#)
- ["Managing Applications in an Application Container"](#)
- ["Synchronizing Applications in an Application PDB"](#)
- *Oracle Database SQL Language Reference* for syntax and semantics of the `AS SEED` clause

## 12.2.1.2 Preparing for an Application Seed

Prerequisites must be met before creating an application seed.

Ensure that the following prerequisites are met before creating an application seed:

- The CDB must exist.  
See [Creating and Configuring a CDB](#).
- The CDB must be in read/write mode.
- The application container to which the application seed will belong must be in read/write mode.
- The current user must be a common user whose current container is the application root to which the application seed will belong.
- The current user must have the `CREATE PLUGGABLE DATABASE` system privilege.
- For the application seed to include the application for the application container, the application must be installed in the application root.

 **See Also:**

- ["About the Current Container"](#)
- [Managing Applications in an Application Container](#)

### 12.2.1.3 Creating an Application Seed

You create an application seed by including the `AS SEED` clause in the `CREATE PLUGGABLE DATABASE` statement.

An application seed in an application container is similar to the seed in a CDB. An application seed enables you to create application PDBs that meet the requirements of an application container quickly and easily.

Before creating an application seed, complete the prerequisites described in "[Preparing for an Application Seed](#)".

1. In SQL\*Plus, ensure that the current container is the application root.
2. Run the `CREATE PLUGGABLE DATABASE` statement, and include the `AS SEED` clause, to create the application seed. Specify other clauses when they are required.

After you create the application seed, it is in mounted mode, and its status is `NEW`. You can view the open mode of an application seed by querying the `OPEN_MODE` column in the `V$PDBS` view. You can view the status of an application seed by querying the `STATUS` column of the `CDB_PDBS` or `DBA_PDBS` view.

A new default service is created for the application seed. The service has the same name as the application seed and can be used to access the application seed. Oracle Net Services must be configured properly for clients to access this service.

3. Open the new application seed in read/write mode.
4. You must open the new application seed in read/write mode for Oracle Database to complete the integration of the new application seed into the application container. An error is returned if you attempt to open the application seed in read-only mode. After the application seed is opened in read/write mode, its status is `NORMAL`.
5. Perform one or more of the following actions:
  - If the application seed was created from the PDB seed, then switch container to the application seed, and use an `ALTER PLUGGABLE DATABASE` statement with the `SYNC` clause to synchronize the application seed. Synchronizing with the application root instantiates one or more of the application root's applications in the application seed.
  - If the application seed was created from an application root, then switch container to the application seed, and run the `pdb_to_apppdb.sql` script to convert the application root to an application PDB.

These actions are not required when the application seed is created by cloning an application PDB.

6. Close the application seed, and then open it in open read-only mode.
7. Back up the application seed.

An application seed cannot be recovered unless it is backed up.

 **Note:**

- If an error is returned during application seed creation, then the application seed being created might be in an `UNUSABLE` state. You can check an application seed's state by querying the `CDB_PDBS` or `DBA_PDBS` view, and you can learn more about application seed creation errors by checking the alert log. An unusable application seed can only be dropped.
- When an application in the application root is upgraded or patched in the application root, the application seed must synchronize with the application root to include the changes.

**Example 12-7 Creating an Application Seed from the PDB seed**

This example assumes the following factors:

- The application seed is being created in an application container named `salesact`.
- Storage limits are not required for the application seed. Therefore, the `STORAGE` clause is not required.
- The application seed does not require a default tablespace.
- The `PATH_PREFIX` clause is not required.
- The `FILE_NAME_CONVERT` clause and the `CREATE_FILE_DEST` clause are not required.

Either Oracle Managed Files is enabled for the CDB, or the `PDB_FILE_NAME_CONVERT` initialization parameter is set. The files associated with the PDB seed will be copied to a new location based on the Oracle Managed Files configuration or the initialization parameter setting.

- There is no file with the same name as the new temp file that will be created in the target location. Therefore, the `TEMPFILE REUSE` clause is not required.
- No predefined Oracle roles need to be granted to the `PDB_DBA` role.

The following statement creates the application seed from the PDB seed, opens the application seed, switches containers to the application seed, synchronizes the application seed with the applications in the application root, closes the application seed, and then opens the application seed in open read-only mode:

```
CREATE PLUGGABLE DATABASE AS SEED ADMIN USER actseedadm IDENTIFIED BY
password;
ALTER PLUGGABLE DATABASE salesact$SEED OPEN;
ALTER SESSION SET CONTAINER=salesact$SEED;
ALTER PLUGGABLE DATABASE APPLICATION ALL SYNC;
ALTER PLUGGABLE DATABASE CLOSE IMMEDIATE;
ALTER PLUGGABLE DATABASE OPEN READ ONLY;
```

Because the application container name is `salesact`, the application seed name is `salesact$SEED`.

A local user with the name of the specified local administrator is created and granted the `PDB_DBA` common role locally in the application seed. If this user was not granted

administrator privileges during application seed creation, then use the `SYS` and `SYSTEM` common users to administer to the application seed.

The application seed was synchronized with the application root when it was created. Therefore, the application seed includes the applications installed in the application root and the application common objects that are part of those applications. When a new application PDB is created using the application seed, the application PDB also includes the installed applications and application common objects.

### Example 12-8 Creating an Application Seed From an Application PDB

This example assumes the following factors:

- The application seed is being created in an application container named `salesact`.
- The application seed is being created in an application PDB in the application container named `salesapppdb`.
- Storage limits are not required for the application seed. Therefore, the `STORAGE` clause is not required.
- The application seed does not require a default tablespace.
- The `PATH_PREFIX` clause is not required.
- The `FILE_NAME_CONVERT` clause and the `CREATE_FILE_DEST` clause are not required.

Either Oracle Managed Files is enabled for the CDB, or the `PDB_FILE_NAME_CONVERT` initialization parameter is set. The files associated with the application root will be copied to a new location based on the Oracle Managed Files configuration or the initialization parameter setting.

- There is no file with the same name as the new temp file that will be created in the target location. Therefore, the `TEMPFILE REUSE` clause is not required.

Given the preceding factors, the following statement creates the application seed from the application root, opens the application seed, closes the application seed, and opens the application seed in open read-only mode:

```
CREATE PLUGGABLE DATABASE AS SEED FROM salesapppdb;
ALTER PLUGGABLE DATABASE salesact$SEED OPEN;
ALTER PLUGGABLE DATABASE CLOSE IMMEDIATE;
ALTER PLUGGABLE DATABASE OPEN READ ONLY;
```

Because the application container name is `salesact`, the application seed name is `salesact$SEED`.

The application seed was created from an application PDB. Therefore, the application seed includes the applications installed in the application root and the application common objects that are part of those applications. When a new application PDB is created using the application seed, the application PDB also includes the installed applications and application common objects.

### Example 12-9 Creating an Application Seed From an Application Root

This example assumes the following factors:

- The application seed is being created in an application container named `salesact`. The application seed is cloned from the root of the application container.

- Storage limits are not required for the application seed. Therefore, the `STORAGE` clause is not required.
- The application seed does not require a default tablespace.
- The `PATH_PREFIX` clause is not required.
- The `FILE_NAME_CONVERT` clause and the `CREATE_FILE_DEST` clause are not required.

Either Oracle Managed Files is enabled for the CDB, or the `PDB_FILE_NAME_CONVERT` initialization parameter is set. The files associated with the application root will be copied to a new location based on the Oracle Managed Files configuration or the initialization parameter setting.

- There is no file with the same name as the new temp file that will be created in the target location. Therefore, the `TEMPFILE REUSE` clause is not required.

Given the preceding factors, the following statement creates the application seed from the application root, opens the application seed, switches containers to the application seed, runs the `pdb_to_apppdb.sql` script to convert the application root to an application PDB, closes the application seed, and opens the application seed in open read-only mode:

```
CREATE PLUGGABLE DATABASE AS SEED FROM salesact;  
ALTER PLUGGABLE DATABASE salesact$SEED OPEN;  
ALTER SESSION SET CONTAINER=salesact$SEED;  
@$ORACLE_HOME/rdbms/admin/pdb_to_apppdb.sql  
ALTER PLUGGABLE DATABASE CLOSE IMMEDIATE;  
ALTER PLUGGABLE DATABASE OPEN READ ONLY;
```

Because the application container name is `salesact`, the application seed name is `salesact$SEED`.

The application seed was created from the application root. Therefore, the application seed includes the applications installed in the application root and the application common objects that are part of those applications. When a new application PDB is created using the application seed, the application PDB also includes the installed applications and application common objects.

## 12.2.2 Unplugging an Application Seed from an Application Container

You can unplug an application seed from an application container.

This section contains the following topics:

- [About Unplugging an Application Seed](#)  
Unplugging an application seed disassociates the application seed from an application container. You unplug an application seed when you no longer want the application seed to be available.
- [Unplugging an Application Seed](#)  
To unplug an application seed, run the `ALTER PLUGGABLE DATABASE ... UNPLUG INTO` statement.

### 12.2.2.1 About Unplugging an Application Seed

Unplugging an application seed disassociates the application seed from an application container. You unplug an application seed when you no longer want the application seed to be available.

Unplugging an application seed is similar to unplugging a PDB. To unplug an application seed, connect to its application root and use the `ALTER PLUGGABLE DATABASE` statement to specify an XML file or a `.pdb` file. When you specify an XML file (`.xml` extension), it will contain metadata about the application seed after it is unplugged. The SQL statement creates the XML file, and it contains the required information to enable a `CREATE PLUGGABLE DATABASE` statement on a target CDB to plug it in as a PDB or an application PDB. When you specify a `.pdb` file, it contains a compressed archive of the XML file that describes the application seed and the files used by the application seed (such as the data files and wallet file). A `.pdb` file enables you to copy a single, compressed file (instead of multiple files) to a new location to plug in as a PDB or an application PDB.

Before it can be unplugged, the application seed must be closed. When you unplug an application seed, the unplugged application seed is in mounted mode. The unplug operation makes some changes in the application seed's data files to record, for example, that the application seed was successfully unplugged. Because it is still part of the application container, the unplugged application seed is included in an RMAN backup of the entire CDB. Such a backup provides a convenient way to archive the unplugged application seed in case it is needed in the future.

To completely remove the application seed from the application container, you can drop it. The only operation supported on an unplugged application seed is dropping the application seed. The application seed must be dropped from the application container before it can be plugged back into the same application container. An application seed is usable only when it is plugged into an application container.

#### See Also:

- ["Unplugging a PDB from a CDB"](#)
- ["Dropping an Application Seed"](#)
- ["Modifying the Open Mode of One or More PDBs"](#) for information about closing a PDB
- ["Modifying a PDB at the System Level"](#) for information about initialization parameters and unplugged PDBs
- *Oracle Database Security Guide* for information about common users and local users



## 12.2.2.2 Unplugging an Application Seed

To unplug an application seed, run the `ALTER PLUGGABLE DATABASE ... UNPLUG INTO` statement.

### Prerequisites

The following prerequisites must be met:

- The current user must have `SYSDBA` or `SYSOPER` administrative privilege, and the privilege must be either commonly granted or locally granted in the application container. The user must exercise the privilege using `AS SYSDBA` or `AS SYSOPER` at connect time.
- The application seed must have been opened at least once.

 **Note:**

If you are unplugging an application seed that includes data that was encrypted with Transparent Data Encryption, then follow the instructions in *Oracle Database Advanced Security Guide*.

### To unplug an application seed:

1. In SQL\*Plus, ensure that the current container is the application root of the application container to which the application seed belongs.
2. Close the application seed.  
In an Oracle Real Application Clusters (Oracle RAC) environment, the application seed must be closed on all instances.
3. Run the `ALTER PLUGGABLE DATABASE` statement with the `UNPLUG INTO` clause, and specify the application seed to unplug and the name and location of the application seed's XML metadata file or `.pdb` file.

### Example 12-10 Unplugging Application Seed `salesact$SEED`

This `ALTER PLUGGABLE DATABASE` statement unplugs the application seed `salesact$SEED` and creates the `salesact$SEED.xml` metadata file in the `/oracle/data/` directory:

```
ALTER PLUGGABLE DATABASE salesact$SEED UNPLUG INTO '/oracle/data/  
salesact$SEED.xml';
```

## 12.2.3 Dropping an Application Seed

You can use the `DROP PLUGGABLE DATABASE` statement to drop an application seed. You can drop an application seed when you no longer need it.

When you drop an application seed, the control file of the CDB is modified to eliminate all references to the dropped application seed. Archived redo log files and backups associated with the application seed are not removed, but you can use Oracle Recovery Manager (RMAN) to remove them.

When dropping an application seed, you can either keep or delete the application seed's data files by using one of the following clauses:

- `KEEP DATAFILES`, the default, retains the data files.  
The application seed's temp file is removed even when `KEEP DATAFILES` is specified because the temp file is no longer needed.
- `INCLUDING DATAFILES` removes the data files from disk.  
If an application seed was created with the `SNAPSHOT COPY` clause, then you must specify `INCLUDING DATAFILES` when you drop the application seed.

The following prerequisites must be met:

- The application seed must be in mounted mode, or it must be unplugged.
- The current user must have `SYSDBA` or `SYSOPER` administrative privilege, and the privilege must be either commonly granted or locally granted in the application container. The user must exercise the privilege using `AS SYSDBA` or `AS SYSOPER` at connect time.

 **Note:**

This operation is destructive.

**To drop an application seed:**

1. In SQL\*Plus, ensure that the current container is the application root of the application container to which the application seed belongs.
2. Run the `DROP PLUGGABLE DATABASE` statement and specify the application seed.

**Example 12-11 Dropping Application Seed salesact\$SEED While Keeping Its Data Files**

```
DROP PLUGGABLE DATABASE salesact$SEED
KEEP DATAFILES;
```

**Example 12-12 Dropping Application Seed salesact\$SEED and Its Data Files**

```
DROP PLUGGABLE DATABASE salesact$SEED
INCLUDING DATAFILES;
```

 **See Also:**

- ["About Container Access in a CDB"](#)
- ["Modifying the Open Mode of One or More PDBs"](#)
- ["Unplugging an Application Seed"](#)
- ["Storage Requirements for Snapshot Copy PDBs"](#)
- *Oracle Database SQL Language Reference*
- *Oracle Database Backup and Recovery User's Guide* for information about RMAN

## 12.3 Creating an Application PDB

You create an application PDB by running the `CREATE PLUGGABLE DATABASE` statement with an application root as the current container.

You can create application PDBs using the same SQL statements that you use to create PDBs in the CDB root. The newly created PDB is an application PDB when the `CREATE PLUGGABLE DATABASE` statement is run in an application root. The statement must be run in an application root and has an explicit dependency on the application database defined in that application root.

Before creating an application PDB, complete the prerequisites described in "[General Prerequisites for PDB Creation](#)". You must also complete the prerequisites for the specific type of PDB you are creating. For example, if you are cloning a PDB, then you must meet the prerequisites PDB cloning.

1. In SQL\*Plus, ensure that the current container is the application root.
2. Run a `CREATE PLUGGABLE DATABASE` statement.

After you create the application PDB, it is in mounted mode, and its status is `NEW`. You can view the open mode of an application PDB by querying the `OPEN_MODE` column in the `V$PDBS` view. You can view the status of an application PDB by querying the `STATUS` column of the `CDB_PDBS` or `DBA_PDBS` view.

A new default service is created for the application PDB. The service has the same name as the application PDB and can be used to access the application PDB. Oracle Net Services must be configured properly for clients to access this service.

3. Open the new application PDB in read/write mode.
4. You must open the new application PDB in read/write mode for Oracle Database to complete the integration of the new application PDB into the application container. An error is returned if you attempt to open the application PDB in read-only mode. After the application PDB is opened in read/write mode, its status is `NORMAL`.
5. Switch container to the application PDB.
6. Use an `ALTER PLUGGABLE DATABASE` statement with the `SYNC` clause to synchronize the application PDB.

Synchronizing with the application PDB instantiates one or more of the application root's applications in the application PDB.

7. Close the application PDB, and then open it in open read-only mode.
8. Back up the application PDB.

An application PDB cannot be recovered unless it is backed up.

 **Note:**

- If an error is returned during application PDB creation, then the application PDB being created might be in an `UNUSABLE` state. You can check an application PDB's state by querying the `CDB_PDBS` or `DBA_PDBS` view, and you can learn more about application PDB creation errors by checking the alert log. An unusable application PDB can only be dropped.
- When an application in the application root is upgraded or patched in the application root, the application PDB must synchronize with the application root to include the changes.

### Related Topics

- [Creating and Removing PDBs and Application Containers](#)  
You can create PDBs, application containers, and application seeds using a variety of techniques.
- [Administering Application Containers](#)  
You can administer application containers, including application roots and application PDBs. You can also administer the applications installed in application containers.

# Part IV

## Administering a Multitenant Environment

You can administer a multitenant environment using SQL\*Plus or Enterprise Manager Cloud Control (Cloud Control).

### Note:

This Part explains how to administer the environment using SQL\*Plus. To learn how to administer the environment with Cloud Control, see "[Administering a Multitenant Environment with Cloud Control](#)".

This part contains the following chapters:

- [Administering a CDB](#)  
Administering a multitenant container database (CDB) includes tasks such as accessing a container, modifying a CDB, executing DDL statements, and running Oracle-supplied SQL scripts.
- [Administering a CDB Fleet](#)  
A **CDB fleet** is a collection of CDBs and hosted PDBs that you can manage as one logical CDB.
- [Administering PDBs](#)  
Administering PDBs includes tasks such as connecting to a PDB, modifying a PDB, and managing services associated with PDBs.
- [Administering a PDB Snapshot Carousel](#)  
You can configure a PDB snapshot carousel for a specified PDB, create snapshots manually or automatically, and set the maximum number of snapshots.
- [Administering Application Containers](#)  
You can administer application containers, including application roots and application PDBs. You can also administer the applications installed in application containers.
- [Managing Security for a Multitenant Environment](#)  
You can manage common and local users and roles for a multitenant environment by using SQL\*Plus and Oracle Enterprise Manager.
- [Monitoring CDBs and PDBs](#)  
You can view information about CDBs and PDBs using SQL\*Plus or SQL Developer.

# 13

## Administering a CDB

Administering a multitenant container database (CDB) includes tasks such as accessing a container, modifying a CDB, executing DDL statements, and running Oracle-supplied SQL scripts.

### Note:

You can complete the tasks in this chapter using SQL\*Plus or Oracle SQL Developer.

This chapter contains the following topics:

- [About CDB Administration](#)  
Administering a CDB is similar to administering a non-CDB, with some differences.
- [Accessing Containers in a CDB](#)  
You can connect to a container by using the SQL\*Plus `CONNECT` command. Alternatively, you can switch into a container with an `ALTER SESSION SET CONTAINER` SQL statement.
- [Modifying a CDB at the System Level](#)  
You can set initialization parameters at the CDB level. In some cases, you can override these parameters at the PDB level.
- [Modifying Containers When Connected to the CDB Root](#)  
You can modify the entire CDB or the root with the `ALTER DATABASE` statement.
- [Executing SQL in a Different Container](#)  
To execute SQL in a different container, use the `CONTAINERS` clause for DML or the `CONTAINER` clause for DDL.
- [Shutting Down a CDB Instance](#)  
You can shut down a CDB instance in the same way that you shut down a non-CDB instance.

### See Also:

["Tools for a Multitenant Environment"](#)

### 13.1 About CDB Administration

Administering a CDB is similar to administering a non-CDB, with some differences.

Most differences occur because some administrative tasks apply to the entire CDB, whereas others apply to specific containers.

This section contains the following topics:

- [About the Current Container](#)  
The data dictionary in each container in a CDB is separate, and the current container is the container whose data dictionary is used for name resolution and for privilege authorization.
- [About Administrative Tasks in a CDB](#)  
Common users perform administrative tasks for a CDB.
- [About Using Manageability Features in a CDB](#)  
For each of Oracle Database's manageability features in a CDB, it is important to understand the data location and the data visibility.
- [About Managing Tablespaces in a CDB](#)  
A tablespace is a logical storage container for database objects, such as tables and indexes, that consume storage space.
- [About Managing Database Objects in a CDB](#)  
In a CDB, different containers can contain different database objects.
- [About Flashing Back a PDB](#)  
You can use the `FLASHBACK PLUGGABLE DATABASE` statement to return a PDB to a past time or system change number (SCN).
- [About Restricting PDB Users for Enhanced Security](#)  
There are several ways to restrict PDB users for enhanced security.
- [Overview of Oracle Multitenant with Oracle RAC](#)  
Oracle Multitenant is an option with Oracle Database 12c that simplifies consolidation, provisioning, upgrades, and more.

## 13.1.1 About the Current Container

The data dictionary in each container in a CDB is separate, and the current container is the container whose data dictionary is used for name resolution and for privilege authorization.

The current container can be the CDB root, an application root, a PDB, or an application PDB. Each session has exactly one current container at any point in time. However, a session can switch from one container to another.

Each container has a unique ID and name in a CDB. You can use the `CON_ID` and `CON_NAME` parameters in the `USERENV` namespace to determine the current container ID and name with the `SYS_CONTEXT` function. For example, the following query returns the current container name:

```
SELECT SYS_CONTEXT ('USERENV', 'CON_NAME') FROM DUAL;
```

You can access a container in various ways. For example, you can use the `SQL*Plus CONNECT` command, and you can use an `ALTER SESSION SET CONTAINER` statement to switch the container of the current session.

The following rules apply to the current container in a CDB:

- The current container can be `CDB$ROOT` (CDB root) only for common users.
- The current container can be a specific PDB for common users and local users.

- The current container can be an application root only for common users or for application common users created in the application root.
- The current container can be a specific application PDB for common users, application common users, and local users.
- The current container must be the CDB root or an application root when a SQL statement includes `CONTAINER = ALL`.

You can include the `CONTAINER` clause in several SQL statements, such as the `CREATE USER`, `ALTER USER`, `CREATE ROLE`, `GRANT`, `REVOKE`, and `ALTER SYSTEM` statements. Note the following rules about `CONTAINER = ALL`:

- When a SQL statement includes `CONTAINER = ALL` and the current container is the CDB root, the SQL statement affects all containers in the CDB, including all PDBs, application roots, and application PDBs.
- When a SQL statement includes `CONTAINER = ALL` and the current container is an application root, the SQL statement affects all containers in the application container, including the application root and all the application PDBs that belong to the application root. The SQL statement does not affect the CDB root or any PDBs or application PDBs that do not belong to the current application root.
- Only a common user or application common user with the commonly granted `SET CONTAINER` privilege can run a SQL statement that includes `CONTAINER = ALL`.

#### See Also:

- ["About Container Access in a CDB"](#)
- ["Executing Code in Containers Using the DBMS\\_SQL Package"](#)
- ["Determining the Current Container ID or Name"](#)
- ["Namespaces in a CDB"](#)
- *Oracle Database SQL Language Reference*
- *Oracle Database Security Guide*

## 13.1.2 About Administrative Tasks in a CDB

Common users perform administrative tasks for a CDB.

A common user has a single identity and can log in to the CDB root, any application root, PDB, or application PDB in which it has privileges. Some tasks, such as starting up a CDB instance, can be performed only by a common user.

Other administrative tasks are the same for a CDB and a non-CDB. The following table describes some of these tasks and provides pointers to the relevant documentation.



**Table 13-1 Administrative Tasks Common to CDBs and Non-CDBs**

Task	Description	Additional Information
Starting up a CDB instance	To start a CDB instance, the current user must be a common user whose current container is the CDB root.  When you open a CDB, the CDB root is opened, but its other containers are mounted. Use the <code>ALTER PLUGGABLE DATABASE</code> statement to modify the open mode of one or more containers.	<i>Oracle Database Administrator's Guide</i> for information about starting up a database  "Modifying the Open Mode of One or More PDBs" "Modifying a PDB with the <code>ALTER PLUGGABLE DATABASE</code> Statement" "About the Current Container"
Managing processes	A CDB has one set of background processes shared by the CDB root and all containers.	<i>Oracle Database Administrator's Guide</i> for information about managing processes
Managing memory	A CDB has a single system global area (SGA) and a single aggregate program global area (PGA). The memory required by a CDB is the sum of the memory requirements for all containers that will be part of the CDB.	<i>Oracle Database Administrator's Guide</i> for information about managing memory
Managing security	You can create and drop common users, application common users, and local users in a CDB. You can also grant privileges to and revoke privileges from these users. You can also manage the <code>CONTAINER_DATA</code> attributes of common users and application common users.  In addition, grant the following roles to the appropriate users: <ul style="list-style-type: none"> <li>Grant the <code>CDB_DBA</code> role to CDB administrators.</li> <li>Grant the <code>PDB_DBA</code> role to application container administrators and PDB administrators.</li> </ul>	<i>Oracle Database Security Guide</i>
Monitoring errors and alerts	A CDB has one alert log for the entire CDB. The name of an application container, PDB, or application PDB is included in records in trace files, when appropriate.	<i>Oracle Database Administrator's Guide</i> for information about monitoring errors and alerts
Managing diagnostic data	In a CDB, you can use the Oracle Database fault diagnosability infrastructure and the Automatic Diagnostic Repository (ADR).	<i>Oracle Database Administrator's Guide</i> for information about managing diagnostic data
Managing control files	A CDB has one control file.	<i>Oracle Database Administrator's Guide</i> for information about managing control files

Table 13-1 (Cont.) Administrative Tasks Common to CDBs and Non-CDBs

Task	Description	Additional Information
Managing the online redo log and the archived redo log files	A CDB has one online redo log and one set of archived redo log files.	<i>Oracle Database Administrator's Guide</i> for information about managing the redo log <i>Oracle Database Administrator's Guide</i> for information about managing archived redo log files
Managing tablespaces	You can create, modify, and drop tablespaces and temporary tablespaces for the CDB root and for individual containers. You can also specify a default tablespace, default tablespace type, and a default temporary tablespace for the CDB root. The CDB root has its own set of Oracle-supplied tablespaces, such as the <code>SYSTEM</code> tablespace, and other containers have their own set of Oracle-supplied tablespaces.	<i>Oracle Database Administrator's Guide</i> for information about managing tablespaces <a href="#">"About Container Modification When Connected to CDB Root"</a>
Managing data files and temp files	The CDB root has its own data files, and other containers have their own data files. In a CDB, you can manage data files and temp files in basically the same way you would manage them for a non-CDB. However, the following exceptions apply to CDBs: <ul style="list-style-type: none"> <li>You can limit the amount of storage used by the data files for a container by using the <code>STORAGE</code> clause in a <code>CREATE PLUGGABLE DATABASE</code> or <code>ALTER PLUGGABLE DATABASE</code> statement.</li> <li>There is a default temporary tablespace for the CDB root and for individual containers.</li> </ul>	<i>Oracle Database Administrator's Guide</i> for information about managing data files and temp files <a href="#">"About Container Modification When Connected to CDB Root"</a> <a href="#">"Storage Limits"</a> <a href="#">"Modifying a PDB at the Database Level"</a>
Managing undo	A CDB can run in local undo mode or shared undo mode. Local undo mode means that every container in the CDB uses local undo. Shared undo mode means that there is one active undo tablespace for a single-instance CDB, or for an Oracle RAC CDB, there is one active undo tablespace for each instance.  In a CDB, the <code>UNDO_MANAGEMENT</code> initialization parameter must be set to <code>AUTO</code> , and an undo tablespace is required to manage the undo data.	<a href="#">"Setting the Undo Mode in a CDB Using ALTER DATABASE"</a> <i>Oracle Database Administrator's Guide</i> for information about managing undo <a href="#">"About the Current Container"</a>

Table 13-1 (Cont.) Administrative Tasks Common to CDBs and Non-CDBs

Task	Description	Additional Information
Moving data between containers	You can move data between containers using the same methods that you would use to move data between non-CDBs. For example, you can transport the data or use Data Pump export/import to move the data.	<i>Oracle Database Administrator's Guide</i> for information about transporting data <i>Oracle Database Utilities</i>
Using Oracle Managed Files	Using Oracle Managed files can simplify administration for both a CDB and a non-CDB.	<i>Oracle Database Administrator's Guide</i> for information about using Oracle Managed Files
Using Transparent Data Encryption	Transparent Data Encryption is a feature that enables encryption of individual table columns before storing them in the data file, or enables encryption of entire tablespaces. In a CDB, each container has its own master key for Transparent Data Encryption, and, where applicable, the <code>ADMINISTER KEY MANAGEMENT SQL</code> statement enables key management at the CDB level and for individual containers.	<i>Oracle Database Advanced Security Guide</i> <a href="#">"About the Current Container"</a>
Using a standby database	Oracle Data Guard can configure a physical standby or a logical standby of a CDB. Data Guard operates on the entire CDB, not on individual containers in a CDB.	<i>Oracle Data Guard Concepts and Administration</i>
Using Oracle Database Vault	Oracle Database Vault common realms can be scoped to an application root on common objects. Database Vault common command rules can be scoped to either the CDB or an application root. Local realms and command rules can be locally scoped to individual PDBs or application PDBs. When Oracle Database Vault security objects are in the CDB root or an application root, enforcement of the security objects only applies to the containers that have Oracle Database Vault enabled.	<i>Oracle Database Vault Administrator's Guide</i>
Dropping a database	When you drop a CDB, all containers in the CDB are dropped along with their data. These containers include the CDB root and PDB seed and all application containers, application seeds, PDBs, and application PDBs. You can also drop individual application containers, application seeds, PDBs, and application PDBs with the <code>DROP PLUGGABLE DATABASE</code> statement.	<i>Oracle Database Administrator's Guide</i> for information about dropping a database <a href="#">"Dropping a PDB"</a>

 **See Also:**

"[Overview of the Multitenant Architecture](#)" for more information about the architecture of a CDB

### 13.1.3 About Using Manageability Features in a CDB

For each of Oracle Database's manageability features in a CDB, it is important to understand the data location and the data visibility.

It is important to understand where the data is stored for Oracle Database's manageability features in a CDB. When the data for a feature is stored in the CDB root only, the data related to a PDB is not included if the PDB is unplugged. However, when the data for a feature is stored in the PDB, the data related to the PDB is included if the PDB is unplugged, and this data remains part of the PDB if it is plugged into the same CDB or a different CDB.

It is also important to understand which data is visible to different users. Generally, in a CDB, a common user can view data for the CDB root and for multiple PDBs when the common user's current container is the CDB root. A common user can view this data by querying container data objects. The specific data that is visible varies for the manageability features. A user whose current container is a PDB can view data for that PDB only.

The following table describes how the manageability features work in a CDB.

**Table 13-2 Manageability Features in a CDB**

Manageability Feature	Data Location	Data Visibility	Additional Information
<p>Active Session History (ASH)</p> <p>ASH collects information about active database sessions. You can use this information to analyze and identify performance issues.</p>	<p>Most of the ASH data is stored in memory. A small percentage of the ASH data samples are stored in the CDB root.</p> <p>ASH data related to a PDB is not included if the PDB is unplugged.</p>	<p>A common user whose current container is the CDB root can view ASH data for the CDB root and for PDBs.</p> <p>A user whose current container is a PDB can view ASH data for the PDB only.</p>	<p><i>Oracle Database 2 Day + Performance Tuning Guide</i></p> <p><i>Oracle Database Performance Tuning Guide</i></p>
<p>Alerts</p> <p>An alert is a notification of a possible problem.</p>	<p>Threshold settings that pertain to a PDB are stored in the PDB.</p> <p>Alerts posted when thresholds are violated are enqueued into the alert queue in the CDB root.</p> <p>Threshold settings that pertain to a PDB are included if the PDB is unplugged. Alerts related to a PDB are not included if the PDB is unplugged.</p>	<p>A common user whose current container is the CDB root can view alerts for the CDB root and for PDBs.</p> <p>A user whose current container is a PDB can view alert thresholds and alerts for the PDB only.</p>	<p><i>Oracle Database Administrator's Guide</i> for information about monitoring errors and alerts</p>

Table 13-2 (Cont.) Manageability Features in a CDB

Manageability Feature	Data Location	Data Visibility	Additional Information
<p>Automated Database Maintenance Tasks</p> <p>Automated database maintenance tasks are tasks that are started automatically at regular intervals to perform maintenance operations on the database. Automated tasks include automatic optimizer statistics collection, Automatic Segment Advisor tasks, and Automatic SQL Tuning Advisor tasks.</p> <p>The <code>ENABLE_AUTOMATIC_MAINTENANCE_PDB</code> initialization parameter can enable or disable the running of automated maintenance tasks for all the PDBs in a CDB or for individual PDBs in a CDB.</p> <p>The <code>AUTOTASK_MAX_ACTIVE_PDBS</code> initialization parameter limits the number of PDBs that can schedule automated maintenance tasks at the same time (during a maintenance window).</p>	<p>A user can schedule maintenance windows and enable or disable maintenance tasks for the current container only. If the current container is the CDB root, then the changes only apply to the CDB root. If the current container is a PDB, then the changes only apply to the PDB.</p> <p>Data related to a PDB is stored in the PDB for automatic optimizer statistics collection and the Automatic Segment Advisor. This data is included if the PDB is unplugged.</p> <p>Automatic SQL Tuning Advisor runs only in the CDB root. See the SQL Tuning Advisor row in this table for information about data collected by Automatic SQL Tuning Advisor.</p>	<p>See the appropriate row in this table for data visibility information about the following manageability features: automatic optimizer statistics collection, Optimizer Statistics Advisor, Automatic Segment Advisor, and Automatic SQL Tuning Advisor.</p>	<p><i>Oracle Database Administrator's Guide</i> for information about managing automated database maintenance tasks</p> <p><i>Oracle Database Reference</i> for information about the <code>ENABLE_AUTOMATIC_MAINTENANCE_PDB</code> initialization parameter</p> <p><i>Oracle Database Reference</i> for information about the <code>AUTOTASK_MAX_ACTIVE_PDBS</code> initialization parameter</p>
<p>Automatic Database Diagnostic Monitor (ADDM)</p> <p>ADDM can diagnose a database's performance and determine how identified problems can be resolved.</p>	<p>All ADDM runs must be performed in the CDB root. All ADDM results are stored in the CDB root.</p> <p>ADDM analyzes activity in a PDB within the context of the current analysis target. ADDM does not analyze one PDB at a time. As in previous releases, ADDM runs with a target of either the entire instance or Oracle Real Application Clusters (Oracle RAC) database.</p> <p>ADDM results related to a PDB are not included if the PDB is unplugged.</p>	<p>ADDM results are visible only to a common user whose current container is the CDB root. The ADDM results can include information about multiple PDBs. The ADDM results cannot be viewed when the current container is a PDB.</p>	<p><i>Oracle Database 2 Day DBA</i></p> <p><i>Oracle Database Performance Tuning Guide</i></p>

Table 13-2 (Cont.) Manageability Features in a CDB

Manageability Feature	Data Location	Data Visibility	Additional Information
<p>Automatic Optimizer Statistics Collection</p> <p>Automatic optimizer statistics collection gathers optimizer statistics for all schema objects in the database for which there are no statistics or only stale statistics. The statistics gathered by this task are used by the SQL query optimizer to improve the performance of SQL execution.</p>	<p>When an automatic optimizer statistics collection task gathers data for a PDB, it stores this data in the PDB. This data is included if the PDB is unplugged.</p>	<p>A common user whose current container is the CDB root can view optimizer statistics data for PDBs.</p> <p>A user whose current container is a PDB can view optimizer statistics data for the PDB only.</p>	<p><a href="#">"Using Oracle Resource Manager for PDBs"</a></p> <p><i>Oracle Database SQL Tuning Guide</i></p>
<p>Automatic Segment Advisor</p> <p>The Automatic Segment Advisor identifies segments that have space available for reclamation and makes recommendations on how to defragment those segments.</p>	<p>When Automatic Segment Advisor gathers data for a PDB, it stores this data in the PDB. This data is included if the PDB is unplugged.</p>	<p>A common user whose current container is the CDB root can view Automatic Segment Advisor data for PDBs.</p> <p>A user whose current container is a PDB can view the Automatic Segment Advisor data for the PDB only.</p>	<p><i>Oracle Database Administrator's Guide</i> for information about reclaiming unused space</p> <p><a href="#">"Using Oracle Resource Manager for PDBs"</a></p>
<p>Automatic Workload Repository (AWR)</p> <p>The AWR collects, processes, and maintains performance statistics for problem detection and self-tuning purposes. This data is stored in the database. The gathered data can be displayed in both reports and views.</p>	<p>AWR reports can be generated in the CDB root or in any PDB. AWR reports generated in the CDB root pertain to the entire CDB, while AWR reports generated when a PDB is the current container only pertain to that PDB.</p> <p>AWR data generated in the CDB root is stored in the CDB root. AWR data generated in a PDB is stored in the PDB.</p> <p>When a PDB is unplugged, AWR data stored in the CDB root is not included.</p> <p>When a PDB is unplugged, AWR data stored in the PDB is included.</p>	<p>A common user whose current container is the CDB root can view AWR data for the CDB root and for PDBs.</p> <p>A user whose current container is a PDB can view AWR data for the PDB only.</p>	<p><i>Oracle Database Performance Tuning Guide</i></p>

**Table 13-2 (Cont.) Manageability Features in a CDB**

Manageability Feature	Data Location	Data Visibility	Additional Information
<p>Database Replay</p> <p>Database Replay is a feature of Oracle Real Application Testing. Database Replay captures the workload for a database and replays it exactly on a test database.</p>	Information about database captures and replays are stored in the CDB root.	A common user whose current container is the CDB root can view database capture and replay information.	<i>Oracle Database Testing Guide</i>
<p>Optimizer Statistics Advisor</p> <p>Optimizer Statistics Advisor analyzes how statistics are being gathered and suggests changes that can be made to fine tune statistics collection.</p>	Data related to a PDB is stored in the PDB for Optimizer Statistics Advisor. This data is included if the PDB is unplugged.	<p>A common user whose current container is the CDB root can view Optimizer Statistics Advisor data for PDBs.</p> <p>A user whose current container is a PDB can view the Optimizer Statistics Advisor data for the PDB only.</p>	<i>Oracle Database SQL Tuning Guide</i>
<p>SQL Management Base (SMB)</p> <p>SMB stores statement logs, plan histories, SQL plan baselines, and SQL profiles in the data dictionary.</p>	SMB data related to a PDB is stored in the PDB. The SMB data related to a PDB is included if the PDB is unplugged.	<p>A common user whose current container is the CDB root can view SMB data for PDBs.</p> <p>A user whose current container is a PDB can view the SMB data for the PDB only.</p>	<i>Oracle Database SQL Tuning Guide</i>
<p>SQL Performance Analyzer (SPA)</p> <p>SPA can analyze the SQL performance impact of SQL tuning and other system changes. SPA is often used with Database Replay.</p>	<p>A common user whose current container is the CDB root can run SPA for any PDB. In this case, the SPA results data is stored in the CDB root and is not included if the PDB is unplugged.</p> <p>A user whose current container is a PDB can run SPA on the PDB. In this case, the SPA results data is stored in the PDB and is included if the PDB is unplugged.</p>	<p>A common user whose current container is the CDB root can view SPA results data for PDBs.</p> <p>A user whose current container is a PDB can view the SPA results data for the PDB only.</p>	<i>Oracle Database Testing Guide</i>



**Table 13-2 (Cont.) Manageability Features in a CDB**

Manageability Feature	Data Location	Data Visibility	Additional Information
<p>SQL Tuning Sets (STS)</p> <p>An STS is a database object that includes one or more SQL statements along with their execution statistics and execution context, and could include a user priority ranking.</p> <p>You can use an STS to tune a group of SQL statements or test their performance using SPA.</p>	<p>An STS can be stored in the CDB root or in any PDB. If it is stored in the CDB root, then you can load SQL statements from any PDB into it.</p> <p>When a PDB is unplugged, an STS stored in the CDB root is not included, even if the STS contains SQL statements from the PDB.</p> <p>When a PDB is unplugged, an STS stored in the PDB is included.</p>	<p>A common user whose current container is the CDB root can view STS data stored in the CDB root only.</p> <p>A user whose current container is a PDB can view STS data for the PDB only.</p>	<p><i>Oracle Database SQL Tuning Guide</i></p>
<p>SQL Tuning Advisor</p> <p>SQL Tuning Advisor optimizes SQL statements that have been identified as high-load SQL statements.</p>	<p>Automatic SQL Tuning Advisor data is stored in the CDB root. It might have results about SQL statements executed in a PDB that were analyzed by the advisor, but these results are not included if the PDB is unplugged.</p> <p>A common user whose current container is the CDB root can run SQL Tuning Advisor manually for SQL statements from any PDB. When a statement is tuned, it is tuned in any container that runs the statement.</p> <p>A user whose current container is a PDB can also run SQL Tuning Advisor manually for SQL statements from the PDB. When SQL Tuning Advisor is run manually from a PDB, the results are stored in the PDB from which it is run. In this case, a statement is tuned only for the current PDB, and the results related to a PDB are included if the PDB is unplugged.</p>	<p>When SQL Tuning Advisor is run automatically, the results are visible only to a common user whose current container is the CDB root. These results cannot be viewed when the current container is a PDB.</p> <p>When SQL Tuning Advisor is run manually by a user whose current container is a PDB, the results are only visible to a user whose current container is that PDB.</p>	<p><i>Oracle Database 2 Day + Performance Tuning Guide</i></p> <p><i>Oracle Database SQL Tuning Guide</i></p>

To run SPA or SQL Tuning Advisor for SQL statements from a PDB, a common user must have the following privileges:

- Common `SET CONTAINER` privilege or local `SET CONTAINER` privilege in the PDB
- The privileges required to execute the SQL statements in the PDB



**See Also:**

- ["About the Current Container"](#)
- ["About CDB and Container Information in Views"](#) for an overview of container data objects
- *Oracle Database Security Guide* for detailed information about container data objects

## 13.1.4 About Managing Tablespaces in a CDB

A tablespace is a logical storage container for database objects, such as tables and indexes, that consume storage space.

At the physical level, a tablespace stores data in one or more data files or temp files. You can use the `ALTER DATABASE` statement to manage tablespaces in a CDB.

The following are considerations for tablespaces in a CDB:

- A permanent tablespace can be associated with exactly one container.
- When you create a tablespace in a container, the tablespace is associated with that container.
- When local undo is disabled for a CDB, the CDB has only one active undo tablespace, or one active undo tablespace for each instance of an Oracle RAC CDB. When local undo is enabled for a CDB, each container in the CDB has its own undo tablespace.
- A local undo tablespace is required for each node in an Oracle Real Application Clusters (Oracle RAC) cluster in which the PDB is open.
- There is one default temporary tablespace each container in the CDB, including the CDB root, each PDB, each application root, and each application PDB.

This section contains the following topics:

- [About Managing Permanent Tablespaces in a CDB](#)  
A permanent tablespace can be associated with only one container. Therefore, a permanent tablespace can be associated with the root or with one PDB.
- [About Managing Temporary Tablespaces in a CDB](#)  
Each container in a CDB has its own default temporary tablespace (or tablespace group).

### 13.1.4.1 About Managing Permanent Tablespaces in a CDB

A permanent tablespace can be associated with only one container. Therefore, a permanent tablespace can be associated with the root or with one PDB.

Each container in a CDB must have its own default permanent tablespace, and default permanent tablespaces cannot be shared between containers. Users connected to the container who are not explicitly assigned a tablespace use the default permanent tablespace for the container.

## 13.1.4.2 About Managing Temporary Tablespaces in a CDB

Each container in a CDB has its own default temporary tablespace (or tablespace group).

You also can create additional temporary tablespaces for individual containers, and you can assign specific users in containers to these temporary tablespaces. When you unplug a PDB, its temporary tablespaces are also unplugged.

When a user is not assigned a temporary tablespace explicitly in a container, the user's temporary tablespace is the default temporary tablespace for the container.

### See Also:

- *Oracle Database Administrator's Guide* for information about managing tablespaces
- ["Unplugging a PDB from a CDB"](#)
- ["Modifying an Entire CDB Using ALTER DATABASE"](#)
- ["Modifying the CDB Root Using ALTER DATABASE"](#)

## 13.1.5 About Managing Database Objects in a CDB

In a CDB, different containers can contain different database objects.

An Oracle database stores database objects, such as tables, indexes, and directories. Database objects that are owned by a schema are called schema objects, while database objects that are not owned by a schema are called nonschema objects. The root and PDBs contain schemas, and schemas contain schema objects. The root and PDBs can also contain nonschema objects, such as users, roles, tablespaces, directories, and editions.

In a CDB, the root contains Oracle-supplied schemas and database objects. Oracle-supplied common users, such as `SYS` and `SYSTEM`, own these schemas and common database objects. They can also own local objects, both in the root and in a PDB.

You can create common users in the root to administer containers in the CDB. User-created common users can create database objects in the root. Oracle recommends that, in the root, schemas owned by user-created common users contain only database triggers and the objects used in their definitions. A user-created common user can also own any type of local object in a PDB.

You can create local users in a PDB. A local user in a PDB can create schema objects and nonschema objects in the PDB. You cannot create local users in the root.

Name resolution in a CDB is similar to name resolution in a non-CDB, except that names are resolved in the context of the dictionary of the user's current container.

 **See Also:**

- ["About the Current Container"](#)
- ["Overview of Common and Local Users in a CDB"](#)
- *Oracle Database Administrator's Guide* for information about managing schema objects
- *Oracle Database SQL Language Reference* for information about schema objects and nonschema objects
- *Oracle Database Security Guide* for information about creating common users and local users

## 13.1.6 About Flashing Back a PDB

You can use the `FLASHBACK PLUGGABLE DATABASE` statement to return a PDB to a past time or system change number (SCN).

You can create restore points for a PDB and flash back the PDB to the restore point without affecting the CDB or other PDBs.

 **Note:**

*Oracle Database Backup and Recovery User's Guide*

## 13.1.7 About Restricting PDB Users for Enhanced Security

There are several ways to restrict PDB users for enhanced security.

A PDB lockdown profile restricts the features and options available to users in a PDB. The `PDB_OS_CREDENTIAL` initialization parameter can specify a unique operating system user for a PDB to limit operating system access. Also, when the `PATH_PREFIX` and `CREATE_FILE_DEST` clauses are specified during PDB creation, they limit file system access.

This section contains the following topics:

- [PDB Lockdown Profiles](#)  
When identities are shared between PDBs, elevated privileges might exist. You can use lockdown profiles to prevent this elevation of privileges.
- [The PDB\\_OS\\_CREDENTIAL Initialization Parameter](#)  
When the database accesses an external procedure with the `extproc` agent, the `PDB_OS_CREDENTIAL` initialization parameter determines the identity of the operating system user employed when interacting with the operating system from a PDB.
- [The PATH\\_PREFIX and CREATE\\_FILE\\_DEST PDB Creation Clauses](#)  
The `PATH_PREFIX` clause of `CREATE PLUGGABLE DATABASE` ensures that all directory object paths associated with the PDB are restricted to the specified directory or its subdirectories.

### 13.1.7.1 PDB Lockdown Profiles

When identities are shared between PDBs, elevated privileges might exist. You can use lockdown profiles to prevent this elevation of privileges.

Identities can be shared in the following situations:

- At the operating system level, when the database interacts with operating system resources such as files or processes
- At the network level, when the database communicates with other systems
- Inside the database, as PDBs access or create common objects or communicate across container boundaries using features such as database links

To increase security, a CDB administrator can use PDB lockdown profiles to restrict users in particular PDBs. A PDB lockdown profile can disable users from running specified SQL statements, such as `ALTER SYSTEM` statements, or disable access to a package that can access the network, such as `UTL_SMTP`. A PDB lockdown profile can also restrict access to common users, common objects, administrative tools such as Oracle XML DB, administrative features such as cursor sharing, and database options such as Oracle Database Advanced Queuing. PDB lockdown profiles can prohibit the use of the XDB protocols (FTP, HTTP, HTTPS) by a PDB with the `XDB_PROTOCOLS` feature.

When logged in to the CDB root or application root, create a lockdown profile by issuing the `CREATE LOCKDOWN PROFILE` statement, which supports the following optional clauses:

- `FROM static_base_profile` creates a new lockdown profile by using the values from an existing profile. Any subsequent changes to the existing profile will not affect the new profile.
- `INCLUDING dynamic_base_profile` creates a new lockdown profile by using the values from an existing profile, except that this new lockdown profile inherits the `DISABLE STATEMENT` rules that comprise the base profile, and any subsequent changes to the base profile.

The user issuing the statement must have the `CREATE LOCKDOWN PROFILE` system privilege in the current container. You can add and remove restrictions with the `ALTER LOCKDOWN PROFILE` statement. The user must issue the `ALTER` statement in the CDB root or application root and must have the `ALTER LOCKDOWN PROFILE` system privilege in the current container.

Specify a lockdown profile by using the `PDB_LOCKDOWN` initialization parameter. This parameter determines whether the PDB lockdown profile applies to a given PDB. You can set this parameter at the following levels:

- PDB  
The profile applies only to the PDB in which it is set.
- Application container  
The profile applies to all application PDBs in the application container. The value can be modified only by an application common user who has application common `SYSDBA` or common `ALTER SYSTEM` privileges or a CDB common user who has common `SYSDBA` or common `ALTER SYSTEM` privileges.
- CDB

The profile applies to all PDBs. A common user who has common `SYSDBA` or common `ALTER SYSTEM` privileges can override a CDB-wide setting for a specific PDB.

If the `PDB_LOCKDOWN` parameter in a PDB is set to the name of a lockdown profile different from the container for this PDB (CDB or application container), then a set of rules govern the interaction between restrictions.

#### See Also:

- *Oracle Database Security Guide* for complete information about lockdown profiles
- *Oracle Database SQL Language Reference* for more information about the `CREATE LOCKDOWN PROFILE` statement
- *Oracle Database Reference* for more information about the `PDB_LOCKDOWN` initialization parameter

### 13.1.7.2 The `PDB_OS_CREDENTIAL` Initialization Parameter

When the database accesses an external procedure with the `extproc` agent, the `PDB_OS_CREDENTIAL` initialization parameter determines the identity of the operating system user employed when interacting with the operating system from a PDB.

Using an OS user described by a credential whose name is specified as a value of the `PDB_OS_CREDENTIAL` initialization parameter can ensure that operating system interactions are performed as a less powerful user. In this way, the feature protects data belonging to one PDB from being accessed by users connected to another PDB. A credential is an object that is created using the `CREATE_CREDENTIAL` procedure in the `DBMS_CREDENTIAL` package.

The Oracle OS user is usually a highly privileged user. Using this account for operating system interactions is not recommended. Also, using the same OS user for operating system interactions from different PDBs might compromise data belonging to a given PDB.

#### See Also:

- *Oracle Database Administrator's Guide* for information about managing processes for external procedures
- *Oracle Database Reference* for more information about the `PDB_OS_CREDENTIAL` initialization parameter
- *Oracle Database PL/SQL Packages and Types Reference*

### 13.1.7.3 The PATH\_PREFIX and CREATE\_FILE\_DEST PDB Creation Clauses

The `PATH_PREFIX` clause of `CREATE PLUGGABLE DATABASE` ensures that all directory object paths associated with the PDB are restricted to the specified directory or its subdirectories.

`PATH_PREFIX` also ensures that the following files associated with the PDB are restricted to specified directory:

- The Oracle XML repository for the PDB
- Files created with a `CREATE PFILE` statement
- The export directory for Oracle wallets
- Library object created with a `CREATE LIBRARY` statement

 **Note:**

The library must use a directory object. If a PDB uses a predefined `PATH_PREFIX`, attempts to use a library object that does not use a directory object result in an `ORA-65394` error. The library object is not invalidated, but to make it usable you must recreate it using a directory object.

The `CREATE_FILE_DEST` clause of the `CREATE PLUGGABLE DATABASE` statement ensures that all the database files belonging to the PDB are restricted to the specified directory and its subdirectories. The clause enables Oracle Managed Files for the PDB and specifies the default file system directory or Oracle ASM disk group for the PDB files.

 **See Also:**

- ["Restrictions on PDB File Locations"](#)
- ["CREATE\\_FILE\\_DEST Clause"](#)

## 13.1.8 Overview of Oracle Multitenant with Oracle RAC

Oracle Multitenant is an option with Oracle Database 12c that simplifies consolidation, provisioning, upgrades, and more.

It is based on an architecture that allows a multitenant container database (CDB) to hold several pluggable databases (PDBs). You can adopt an existing database as a PDB without having to change the application tier. In this architecture, Oracle RAC provides the local high availability that is required when consolidating various business-critical applications on one system.

When using PDBs with Oracle RAC, the multitenant CDB is based on Oracle RAC. You can make each PDB available on either every instance of the Oracle RAC CDB or a subset of instances. In either case, access to and management of the PDBs are regulated using dynamic database services, which will also be used by applications to

connect to the respective PDB, as they would in a single instance Oracle database using Oracle Net Services for connectivity.

You can isolate PDBs to prevent certain operations from being performed on or within a particular PDB that may interfere with other PDBs sharing the same Oracle RAC database or database instance. PDB isolation allows for a higher degree of consolidation using Oracle Multitenant.

If you create an Oracle RAC database as a CDB and plug one or more PDBs into the CDB, then, by default, a PDB is not started automatically on any instance of the Oracle RAC CDB. With the first dynamic database service assigned to the PDB (other than the default database service which has the same name as the database name), the PDB is made available on those instances on which the service runs.

Whether a PDB is available on more than one instance of an Oracle RAC CDB, the CDB is typically managed by the services running on the PDB. You can manually enable PDB access on each instance of an Oracle RAC CDB by starting the PDB manually on that instance.

#### Related Topics

- [Oracle Real Application Clusters Administration and Deployment Guide](#)

## 13.2 Accessing Containers in a CDB

You can connect to a container by using the SQL\*Plus `CONNECT` command. Alternatively, you can switch into a container with an `ALTER SESSION SET CONTAINER` SQL statement.



#### Note:

You can also log in using Oracle Enterprise Manager Cloud Control (Cloud Control). See "[Logging into a Multitenant Environment in Enterprise Manager](#)".

This section contains the following topics:

- [About Container Access in a CDB](#)  
You can use SQL\*Plus to access the root or a PDB in a CDB.
- [Accessing a Container in a CDB](#)  
Access a container in a CDB with SQL\*Plus by issuing a `CONNECT` or `ALTER SESSION` command.

### 13.2.1 About Container Access in a CDB

You can use SQL\*Plus to access the root or a PDB in a CDB.

 **Note:**

This section assumes that you understand how to connect to a non-CDB in SQL\*Plus.

This section contains the following topics:

- [Services in a CDB](#)  
Clients access the root or a PDB through database services.
- [Session Limits in a CDB](#)  
The setting for the `SESSIONS` initialization parameter limits the total number of sessions available in a CDB, including the sessions connected to PDBs.
- [User Names in a Multitenant Environment](#)  
Within each PDB, a user name must be unique with respect to other user names and roles in that PDB.
- [How the Multitenant Option Affects Password Files for Administrative Users](#)  
In a multitenant environment, the password information for the local and common administrative users is stored in different locations.

 **See Also:**

- *Oracle Database Administrator's Guide* for information about submitting commands and SQL to the database
- *Oracle Database Net Services Administrator's Guide* for information about configuring Oracle Net Services

### 13.2.1.1 Services in a CDB

Clients access the root or a PDB through database services.

Database services have an optional `PDB` property. When a PDB is created, a new default service for the PDB is created automatically. The service has the same name as the PDB. With the service name, you can access the PDB using the easy connect syntax or the net service name from the `tnsnames.ora` file. Oracle Net Services must be configured properly for clients to access this service.

When a user connects using a service with a non-null `PDB` property, the user name is resolved in the context of the specified PDB. When a user connects without specifying a service or using a service name with a null `PDB` property, the user name is resolved in the context of the root. You can view the `PDB` property for a service by querying the `CDB_SERVICES` data dictionary view or by running the `config service` command in the `SRVCTL` utility.



 **Note:**

When two or more CDBs on the same computer system use the same listener and two or more PDBs have the same service name in these CDBs, a connection that specifies this service name connects randomly to one of the PDBs with the service name. To avoid incorrect connections, ensure that all service names for PDBs are unique on the computer system, or configure a separate listener for each CDB on the computer system.

 **See Also:**

- ["Overview of Services in a CDB"](#)
- ["Managing Services for PDBs"](#)
- ["Example 19-9"](#)

### 13.2.1.2 Session Limits in a CDB

The setting for the `SESSIONS` initialization parameter limits the total number of sessions available in a CDB, including the sessions connected to PDBs.

If the limit is reached for the CDB, then users cannot connect to PDBs. To ensure that one PDB does not use too many sessions, you can limit the number of sessions available to a PDB by setting the `SESSIONS` initialization parameter in the PDB.

 **See Also:**

["Listing the Modifiable Initialization Parameters in PDBs"](#)

### 13.2.1.3 User Names in a Multitenant Environment

Within each PDB, a user name must be unique with respect to other user names and roles in that PDB.

Note the following restrictions:

- For local user names, the name cannot start with `C##` (or `c##`)
- A user and a role cannot have the same name.

**Related Topics**

- *Oracle Database Security Guide*

### 13.2.1.4 How the Multitenant Option Affects Password Files for Administrative Users

In a multitenant environment, the password information for the local and common administrative users is stored in different locations.

- **For CDB administrative users:** The password information (hashes of the password) for the CDB common administrative users to whom administrative privileges were granted in the CDB root is stored in the password file.
- **For all users in a CDB to whom administrative privileges were granted outside the CDB root:** To view information about the password hash information of these users, query the `$PWFFILE_USERS` dynamic view.

#### Related Topics

- *Oracle Database Security Guide*

## 13.2.2 Accessing a Container in a CDB

Access a container in a CDB with SQL\*Plus by issuing a `CONNECT` or `ALTER SESSION` command.

This section contains the following topics:

- [Connecting to a Container Using the SQL\\*Plus `CONNECT` Command](#)  
You can use the SQL\*Plus `CONNECT` command to connect to the root or to a PDB.
- [Switching to a Container Using the `ALTER SESSION` Statement](#)  
When you are connected to a container as a common user, you can switch to a different container and application service using the `ALTER SESSION` statement.

### 13.2.2.1 Connecting to a Container Using the SQL\*Plus `CONNECT` Command

You can use the SQL\*Plus `CONNECT` command to connect to the root or to a PDB.

This section contains the following topics:

- [Connecting to the Root Using the SQL\\*Plus `CONNECT` Command](#)  
You can connect to the root in the same way that you connect to a non-CDB.
- [Connecting to a PDB Using the SQL\\*Plus `CONNECT` Command](#)  
To connect to a PDB with the SQL\*Plus `CONNECT` command, you can use easy connect or a net service name.

#### 13.2.2.1.1 Connecting to the Root Using the SQL\*Plus `CONNECT` Command

You can connect to the root in the same way that you connect to a non-CDB.

Specifically, you can use the following techniques to connect to the root with the SQL\*Plus `CONNECT` command:

- Local connection
- Local connection with operating system authentication
- Database connection using easy connect

- Database connection using a net service name
- Remote database connection using external authentication

The following prerequisites must be met for the user connecting to the root:

- The user must be a common user.
- The user must be granted `CREATE SESSION` privilege in the root.

**To connect to the root using the SQL\*Plus `CONNECT` command:**

1. Configure your environment so that you can open SQL\*Plus.
2. Start SQL\*Plus with the `/NOLOG` argument:

```
sqlplus /nolog
```

3. Issue a SQL\*Plus `CONNECT` command to connect to the root, as shown in the following examples.

#### **Example 13-1 Connecting to the Root with a Local Connection**

This example connects to the root in the local CDB as user `SYSTEM`. SQL\*Plus prompts for the `SYSTEM` user password.

```
connect system
```

#### **Example 13-2 Connecting to the Root with Operating System Authentication**

This example connects locally to the root with the `SYSDBA` administrative privilege with operating system authentication.

```
connect / as sysdba
```

#### **Example 13-3 Connecting to the Root with a Net Service Name**

Assume that clients are configured to have a net service name for the root in the CDB. For example, the net service name can be part of an entry in a `tnsnames.ora` file.

This example connects as common user `c##dba` to the database service designated by the net service name `mycdb`. SQL\*Plus prompts for the `c##dba` user password.

```
connect c##dba@mycdb
```

#### **See Also:**

*Oracle Database Administrator's Guide* for information about submitting commands and SQL to the database

### 13.2.2.1.2 Connecting to a PDB Using the SQL\*Plus CONNECT Command

To connect to a PDB with the SQL\*Plus `CONNECT` command, you can use easy connect or a net service name.

To connect to a PDB, a user must be one of the following:

- A common user with a `CREATE SESSION` privilege granted commonly or granted locally in the PDB
- A local user defined in the PDB with `CREATE SESSION` privilege

Only a user with `SYSDBA`, `SYSOPER`, `SYSBACKUP`, or `SYSDG` privilege can connect to a PDB that is in mounted mode. To change the open mode of a PDB, see "[Modifying the Open Mode of One or More PDBs](#)".

**To connect to a PDB using the SQL\*Plus `CONNECT` command:**

1. Configure your environment so that you can open SQL\*Plus.
2. Start SQL\*Plus with the `/NOLOG` argument:

```
sqlplus /nolog
```

3. Issue a SQL\*Plus `CONNECT` command using easy connect or a net service name to connect to the PDB.

#### **Example 13-4 Connecting to a PDB**

Assume that clients are configured to have a net service name for each PDB that matches each PDB name. For example, the net service name can be part of an entry in a `tnsnames.ora` file.

The following command connects to the `sh` local user in the `salespdb` PDB:

```
CONNECT sh@salespdb
```

The following command connects to the `SYSTEM` common user in the `salespdb` PDB:

```
CONNECT system@salespdb
```

#### **See Also:**

*Oracle Database Administrator's Guide* for information about submitting the SQL\*Plus `CONNECT` command

## 13.2.2.2 Switching to a Container Using the ALTER SESSION Statement

When you are connected to a container as a common user, you can switch to a different container and application service using the `ALTER SESSION` statement.

You can use the following statement to switch to a different container and application service:

```
ALTER SESSION SET CONTAINER = container_name [SERVICE = service_name]
```

For *container\_name*, specify one of the following:

- `CDB$ROOT` to switch to the CDB root
- `PDB$SEED` to switch to the PDB seed
- A PDB name to switch to the PDB

When the current container is the root, you can view the names of the PDBs in a CDB by querying the `DBA_PDBS` view.

For *service\_name*, specify a service that is running in the PDB. You can list the services running in the containers of a CDB, excluding the CDB root, by issuing the following query with the CDB root as the current container:

```
COL NAME FORMAT A30
COL CON_NAME FORMAT A20

SELECT NAME, CON_NAME, CON_ID
FROM V$ACTIVE_SERVICES
WHERE UPPER(NAME) != CON_NAME
AND CON_ID != 1
ORDER BY CON_ID;
```

By default, when you switch to a container, the session uses the default service for the container. However, the default PDB service does not support all service attributes and features such as service metrics, Fast Application Notification (FAN), load balancing, Resource Manager, Transaction Guard, Application Continuity, and so on. It is best practice to use a nondefault service for the container by specifying `SERVICE = service_name`, where *service\_name* is the name of the service.

With this new capability, connection pools can switch the service, and, when needed the PDB, on a connection when a connection is borrowed from the pool. Starting with Oracle Database 12c Release 2 (12.2.0.1), connection pools support more than one database service with universal connection pools (UCPs). It can also be used standalone.

When switching to a service, applications can consolidate to a CDB, while keeping the database services identified, prioritized, measured, and highly available. Switching to a nondefault service provides the following benefits:

- It preserves the service attributes and features.
- It eliminates too many connection pools with too many connections serving these tenants.

- It allows applications to use more database services for workload control without consuming too many connection pools. Customers can identify and prioritize workloads using services without over sizing the database connections.

The following are considerations for using the `ALTER SESSION SET CONTAINER` statement:

- After the statement completes successfully, the current schema of the session is set to the schema owned by the common user in the specified container.
- After the statement completes successfully, the security context is reset to that of the schema owned by the common user in the specified container.
- After the statement completes successfully, login triggers for the specified container do not fire.

If you require a trigger, then you can define a before or after `SET CONTAINER` trigger in a PDB to fire before or after the `ALTER SESSION SET CONTAINER` statement is executed.

- After the statement completes successfully and the `SERVICE` clause specifies a nondefault service for the PDB, the session is using a new service with attributes set, including metrics, FAN, TAF, Application Continuity, Transaction Guard, `drain_timeout`, and `stop_option` for the new service.
- Package states are not shared across containers.
- When closing a PDB, sessions that switched into the PDB and sessions that connected directly to the PDB are handled identically.
- A transaction cannot span multiple containers. If you start a transaction and use `ALTER SESSION SET CONTAINER` to switch to a different container, then you cannot issue DML, DDL, `COMMIT`, or `ROLLBACK` statements until you switch back to the container in which you started the transaction.
- If you open a cursor and use `ALTER SESSION SET CONTAINER` to switch to different container, then you cannot fetch data from that cursor until you switch back to the container in which the cursor was opened.
- You can use the `ALTER SESSION SET CONTAINER` statement with the `SERVICE` clause for connection pooling as well as advanced CDB administration.

For example, you can use this statement for connection pooling with PDBs for a multitenant application. A multitenant application uses a single instance of the software on a server to serve multiple customers (tenants). In a non-CDB, multitenant is typically supported by adding an extra column that identifies the tenant to every table used by the application, and tenants check out connections from a connection pool. In a CDB with PDBs, each tenant can have its own PDB, and you can use the `ALTER SESSION SET CONTAINER` statement in a connection pooling configuration.

- When working with connection pools that serve applications, the applications may be using data sources with different services. Using the `ALTER SESSION SET CONTAINER` statement with the `SERVICE` clause enables the connection pool to use the same connections for many applications, sharing the services.

The following prerequisites must be met to use the `ALTER SESSION SET CONTAINER` statement:

- The current user must be a common user. The initial connection must be made using the SQL\*Plus `CONNECT` command.

- When altering a session to switch to a PDB as a common user that was not supplied with Oracle Database, the current user must be granted the `SET CONTAINER` privilege commonly or must be granted this privilege locally in the PDB.



**Note:**

When an `ALTER SESSION SET CONTAINER` statement is used to switch to the current container, these prerequisites are not enforced, and no error message is returned if they are not met.

Before issuing an `ALTER SESSION SET CONTAINER` statement with the `SERVICE` clause, the following prerequisites must be met:

- The service switched to must be active. You cannot switch to a service that is not running.
- When switching between services, the service attributes of the service being switched from and the service being switched to must match. For example, the services switched from and to must all have TAF, or must all use Application Continuity, or must all have `drain_timeout` set.

**To switch to a container using the `ALTER SESSION` statement:**

1. In SQL\*Plus, connect to a container as a common user with the required privileges.
2. Check the current open mode of the container to which you are switching.

To check the current open mode of the root or a PDB, query the `OPEN_MODE` column in the `V$CONTAINERS` view when the current container is the root.

If the open mode of the root should be changed, then follow the instructions in *Oracle Database Administrator's Guide* about altering database availability to change the open mode.

If the open mode of the PDB should be changed, then follow the instructions in ["Modifying the Open Mode of One or More PDBs"](#) to change the open mode.

The open mode of the root imposes limitations on the open mode of PDBs. For example, the root must be open before any PDBs can be open. Therefore, you might need to change the open mode of the root before changing the open mode of a PDB.

3. If you are switching to a specific service, then ensure that the service is running.  
To check the active status of the service, query the `V$ACTIVE_SERVICES` view when the current container is the CDB root.  
If the service is not running, then use the `SRVCTL` utility or the `DBMS_SERVICE` package to start the service.
4. Run the `ALTER SESSION SET CONTAINER` statement and specify the container to which you want to switch.

Include the `SERVICE` clause to switch to a specific application service.

The following examples switch to various containers using `ALTER SESSION`.

**Example 13-5 Switching to the PDB salespdb and Using the salesrep Service**

```
ALTER SESSION SET CONTAINER = salespdb SERVICE = salesrep;
```

**Example 13-6 Switching to the PDB salespdb and Using the Default Service**

```
ALTER SESSION SET CONTAINER = salespdb;
```

**Example 13-7 Switching to the CDB Root**

```
ALTER SESSION SET CONTAINER = CDB$ROOT;
```

**Example 13-8 Switching to the PDB Seed**

```
ALTER SESSION SET CONTAINER = PDB$SEED;
```

**Example 13-9 Switching Services Using a Dummy Service in the CDB Root**

To design connection pooling that switches the container and the service, one method is to create a dummy service in the CDB root and set all required service attributes on this dummy service (for example, `drain_timeout`, TAF or Application Continuity). The service attributes must match across the CDB root and the PDB. To use this method, complete the following steps:

1. Connect to the dummy service when first creating the connection pool and when creating new connections.
2. As services are added to each PDB, set the same attributes on these real services.
3. When an application requires a connection, complete one of the following actions:
  - Create a new connection to the dummy service, and switch to the PDB and service.
  - Borrow a free connection in the pool and switch to the PDB and service.You do not need to return to the CDB root when switching across PDBs.

You do not need to return to the CDB root when switching across PDBs.

 **See Also:**

- *Oracle Database Administrator's Guide* for information about database resident connection pooling
- *Oracle Universal Connection Pool Developer's Guide* for more information about universal connection pools



## 13.3 Modifying a CDB at the System Level

You can set initialization parameters at the CDB level. In some cases, you can override these parameters at the PDB level.

This section contains the following topics:

- [About System-Level Modifications of a CDB](#)  
The `ALTER SYSTEM SET` statement dynamically sets an initialization parameter in one or more containers.
- [Modifying a CDB with ALTER SYSTEM](#)  
To modify a CDB at the system level, use the `ALTER SYSTEM` statement.

### 13.3.1 About System-Level Modifications of a CDB

The `ALTER SYSTEM SET` statement dynamically sets an initialization parameter in one or more containers.

A CDB uses an inheritance model for initialization parameters in which PDBs inherit initialization parameter values from the root. In this case, inheritance means that the value of a specific parameter in the root applies to a specific PDB.

A PDB can override the root setting for some parameters. In such cases, a PDB has an inheritance property for each initialization parameter that is either true or false. The inheritance property is true for a parameter when the PDB inherits the root's value for the parameter; otherwise, the property is false.

The inheritance property for some parameters must be true. For other parameters, when the current container is the PDB, you can change the inheritance property by running the `ALTER SYSTEM SET` statement. If `V$SYSTEM_PARAMETER.ISPDB_MODIFIABLE` is `TRUE` for an initialization parameter, then the inheritance property can be false for the parameter.

When the current container is the root, the `CONTAINER` clause of the `ALTER SYSTEM SET` statement controls which PDBs inherit the parameter value being set. The `CONTAINER` clause has the following syntax:

```
CONTAINER = { CURRENT | ALL }
```

The following settings are possible:

- `CURRENT`  
The parameter setting applies only to the current container. This is the default setting for `CONTAINER`. When the current container is the root, the parameter setting applies to the root and to any PDB with an inheritance property of true for the parameter.
- `ALL`  
The parameter setting applies to all containers in the CDB, including the root and all PDBs. Specifying `ALL` sets the inheritance property to true for the parameter in all PDBs.

 **See Also:**

"[About the Current Container](#)" for more information about the `CONTAINER` clause and rules that apply to it

## 13.3.2 Modifying a CDB with ALTER SYSTEM

To modify a CDB at the system level, use the `ALTER SYSTEM` statement.

### Prerequisites

The current user must have the commonly granted `ALTER SYSTEM` privilege.

### To use ALTER SYSTEM SET in the root in a CDB:

1. In SQL\*Plus, ensure that the current container is the root.
2. Run the `ALTER SYSTEM SET` statement.

 **Note:**

To change the inheritance property for a parameter in a PDB from false to true, run the `ALTER SYSTEM RESET` statement to reset the parameter when the current container is the PDB. The following sample statement resets the `OPEN_CURSORS` parameter:

```
ALTER SYSTEM RESET OPEN_CURSORS SCOPE = SPFILE;
```

### Example 13-10 Setting an Initialization Parameter for All Containers

This `ALTER SYSTEM SET` statement sets the `OPEN_CURSORS` initialization parameter to 200 for the all containers and sets the inheritance property to `TRUE` in each PDB.

```
ALTER SYSTEM SET OPEN_CURSORS = 200 CONTAINER = ALL;
```

### Example 13-11 Setting an Initialization Parameter for the Root

This `ALTER SYSTEM SET` statement sets the `OPEN_CURSORS` initialization parameter to 200 for the root and for PDBs with an inheritance property of `true` for the parameter.

```
ALTER SYSTEM SET OPEN_CURSORS = 200 CONTAINER = CURRENT;
```

 **See Also:**

- ["Modifying a PDB at the System Level"](#)
- *Oracle Database SQL Language Reference* for more information about the `ALTER SYSTEM SET` statement

## 13.4 Modifying Containers When Connected to the CDB Root

You can modify the entire CDB or the root with the `ALTER DATABASE` statement.

This section contains the following topics:

- [About Container Modification When Connected to CDB Root](#)  
The `ALTER DATABASE` statement modifies a CDB. When you are connected to the CDB root, the `ALTER PLUGGABLE DATABASE` statement can modify the open mode of one or more PDBs.
- [Modifying an Entire CDB Using ALTER DATABASE](#)  
You can use the `ALTER DATABASE` statement to modify an entire CDB, including the root and all PDBs. Most `ALTER DATABASE` statements modify the entire CDB.
- [Setting the Undo Mode in a CDB Using ALTER DATABASE](#)  
When local undo is enabled, each container has its own undo tablespace for every instance in which it is open. When local undo is disabled, there is one undo tablespace for the entire CDB.
- [Modifying the CDB Root Using ALTER DATABASE](#)  
To modify only the root of a CDB, use the `ALTER DATABASE` statement.
- [Modifying the Open Mode of One or More PDBs](#)  
You can modify the open mode of a PDB by using the `ALTER PLUGGABLE DATABASE SQL` statement or the `SQL*Plus STARTUP` command.

### 13.4.1 About Container Modification When Connected to CDB Root

The `ALTER DATABASE` statement modifies a CDB. When you are connected to the CDB root, the `ALTER PLUGGABLE DATABASE` statement can modify the open mode of one or more PDBs.

The behavior of `ALTER DATABASE` and `ALTER PLUGGABLE DATABASE` depends on which container you are connected to when you use the statement:

- Connected as a common user to CDB root  
In this case, the `ALTER DATABASE` statement works the same as in a non-CDB. When an `ALTER DATABASE` statement with the `RENAME GLOBAL_NAME` clause modifies the domain of a CDB, it affects the domain of each PDB with a domain that defaults to that of the CDB. The `ALTER PLUGGABLE DATABASE` statement with the `pdb_change_state` clause modifies the open mode of one or more PDBs.
- Connected to a PDB

In this case, the ALTER DATABASE and ALTER PLUGGABLE DATABASE statements modify the current PDB only.

The following table lists which containers are modified by clauses in ALTER DATABASE and ALTER PLUGGABLE DATABASE statements.

**Table 13-3 Statements That Modify Containers in a CDB**

Modify Entire CDB	Modify Root Only	Modify One or More PDBs
When connected as a common user whose current container is the root, ALTER DATABASE statements with the following clauses modify the entire CDB: <ul style="list-style-type: none"> <li>• <i>startup_clauses</i></li> <li>• <i>recovery_clauses</i></li> <li>• <i>logfile_clauses</i></li> <li>• <i>controlfile_clauses</i></li> <li>• <i>standby_database_clauses</i></li> <li>• <i>instance_clauses</i></li> <li>• <i>security_clause</i></li> <li>• RENAME GLOBAL_NAME clause</li> <li>• ENABLE BLOCK CHANGE TRACKING clause</li> <li>• DISABLE BLOCK CHANGE TRACKING clause</li> </ul>	When connected as a common user whose current container is the root, ALTER DATABASE statements with the following clauses modify the root only: <ul style="list-style-type: none"> <li>• <i>database_file_clauses</i></li> <li>• DEFAULT EDITION clause</li> <li>• DEFAULT TABLESPACE clause</li> <li>• DEFAULT TEMPORARY TABLESPACE clause</li> </ul> ALTER DATABASE statements with the following clauses modify the root and set default values for PDBs: <ul style="list-style-type: none"> <li>• <i>flashback_mode_clause</i></li> <li>• SET DEFAULT {BIGFILE   SMALLFILE} TABLESPACE clause</li> <li>• <i>set_time_zone_clause</i></li> </ul> You can use these clauses to set nondefault values for specific PDBs.	When connected as a common user whose current container is the root, ALTER PLUGGABLE DATABASE statements with the following clause can modify the open mode of one or more PDBs: <ul style="list-style-type: none"> <li>• <i>pdb_change_state</i></li> </ul> When the current container is a PDB, ALTER PLUGGABLE DATABASE statements with this clause can modify the open mode of the current PDB.                     When connected as a common user whose current container is the root, ALTER PLUGGABLE DATABASE statements with the following clause can preserve or discard the open mode a PDB when the CDB restarts: <ul style="list-style-type: none"> <li>• <i>pdb_save_or_discard_state</i></li> </ul>

 See Also:

- ["About the Current Container"](#)
- ["Modifying a PDB at the Database Level"](#)
- *Oracle Database SQL Language Reference*

## 13.4.2 Modifying an Entire CDB Using ALTER DATABASE

You can use the ALTER DATABASE statement to modify an entire CDB, including the root and all PDBs. Most ALTER DATABASE statements modify the entire CDB.

For a list of statements that modify the entire CDB rather than the root or individual PDBs, see the "Modify Entire CDB" column of ["About Container Modification When Connected to CDB Root"](#).

### Prerequisites

To modify an entire CDB, the following prerequisites must be met:

- The current user must be a common user with the `ALTER DATABASE` privilege.
- To use an `ALTER DATABASE` statement with a *recovery\_clause*, the current user must have the `SYSDBA` administrative privilege commonly granted. In this case, you must exercise this privilege using `AS SYSDBA` at connect time.

#### To modify an entire CDB:

1. In SQL\*Plus, ensure that the current container is the root.
2. Use an `ALTER DATABASE` statement with a clause that modifies an entire CDB.

#### Example 13-12 Backing Up the Control File for a CDB

The following `ALTER DATABASE` statement uses a *recovery\_clause* to back up a control file.

```
ALTER DATABASE BACKUP CONTROLFILE TO '+DATA/dbs/backup/control.bkp';
```

#### Example 13-13 Adding a Redo Log File to a CDB

The following `ALTER DATABASE` statement uses a *logfile\_clause* to add redo log files.

```
ALTER DATABASE cdb ADD LOGFILE  
GROUP 4 ('/u01/logs/orcl/redo04a.log', '/u02/logs/orcl/redo04b.log')  
SIZE 100M BLOCKSIZE 512 REUSE;
```



#### See Also:

*Oracle Database SQL Language Reference*

## 13.4.3 Setting the Undo Mode in a CDB Using ALTER DATABASE

When local undo is enabled, each container has its own undo tablespace for every instance in which it is open. When local undo is disabled, there is one undo tablespace for the entire CDB.

This section contains the following topics:

- [About the CDB Undo Mode](#)  
You can configure a CDB to use local undo in every container or to use shared undo for the entire CDB.
- [Configuring a CDB to Use Local Undo Mode](#)  
You can change a CDB to local undo mode by issuing an `ALTER DATABASE LOCAL UNDO ON` statement and restarting the database.
- [Configuring a CDB to Use Shared Undo Mode](#)  
To change a CDB to use shared undo mode, use an `ALTER DATABASE LOCAL UNDO OFF` statement.

### 13.4.3.1 About the CDB Undo Mode

You can configure a CDB to use local undo in every container or to use shared undo for the entire CDB.

A CDB can run in local or shared undo mode. The undo mode applies to the entire CDB. Therefore, every container either uses shared undo or local undo.

Specify the undo mode of a CDB during CDB creation in the `ENABLE PLUGGABLE DATABASE` clause of the `CREATE DATABASE` statement. You can change the undo mode of a CDB after it is created by issuing an `ALTER DATABASE` statement and restarting the CDB.

To determine the current CDB undo mode, run the following query in the CDB root:

```
SELECT PROPERTY_NAME, PROPERTY_VALUE
FROM   DATABASE_PROPERTIES
WHERE  PROPERTY_NAME = 'LOCAL_UNDO_ENABLED' ;
```

If the query returns `TRUE` for the `PROPERTY_VALUE`, then the CDB is in local undo mode. Otherwise, the CDB is in shared undo mode.

This section contains the following topics:

- [About Local Undo Mode](#)  
Local undo mode means that each container has its own undo tablespace for every instance in which it is open.
- [About Shared Undo Mode](#)  
Shared undo mode means that only one active undo tablespace exists for a single-instance CDB. For an Oracle RAC CDB, there is one active undo tablespace for each instance.

#### 13.4.3.1.1 About Local Undo Mode

Local undo mode means that each container has its own undo tablespace for every instance in which it is open.

In this mode, Oracle Database automatically creates an undo tablespace for every container in the CDB. For an Oracle RAC CDB, there is one active undo tablespace for each instance for each PDB in local undo mode.

Local undo mode provides increased isolation for each container and improves the efficiency of some operations, such as unplugging the container or performing point-in-time recovery on the container. In addition, local undo mode is required for some operations to be supported, such as relocating a PDB or cloning a PDB that is in open read/write mode.

When a CDB is in local undo mode, the following applies:

- Any user who has the appropriate privileges for the current container can create an undo tablespace for the container.
- Undo tablespaces are visible in static data dictionary views and dynamic performance (V\$) views in every container in the CDB.



**See Also:**

*Oracle Database SQL Language Reference* for information about the required privileges

### 13.4.3.1.2 About Shared Undo Mode

Shared undo mode means that only one active undo tablespace exists for a single-instance CDB. For an Oracle RAC CDB, there is one active undo tablespace for each instance.

When a CDB is in shared undo mode, the following applies:

- Only a common user who has the appropriate privileges and whose current container is the CDB root can create an undo tablespace.
- When the current container is not the CDB root, an attempt to create an undo tablespace fails and returns an error.
- Undo tablespaces are visible in static data dictionary views and dynamic performance (V\$) views when the current container is the CDB root. Undo tablespaces are visible only in dynamic performance views when the current container is a PDB, an application root, or an application PDB.



**Note:**

- When you change the undo mode of a CDB, the new undo mode applies to an individual container the first time the container is opened after the change.
- When you change the undo mode of a CDB, containers in the CDB cannot flash back to a time or SCN that is prior to the change.

### 13.4.3.2 Configuring a CDB to Use Local Undo Mode

You can change a CDB to local undo mode by issuing an `ALTER DATABASE LOCAL UNDO ON` statement and restarting the database.

When a CDB is in local undo mode, each container has its own undo tablespace for every instance in which it is open. Oracle Database automatically creates an undo tablespace in any container in the CDB that does not have one. If a PDB without an undo tablespace is cloned, relocated, or plugged into a CDB that is configured to use local undo mode, then Oracle Database automatically creates an undo tablespace for the PDB the first time it is opened.

When a CDB is changed from shared undo mode to local undo mode, Oracle Database creates the required undo tablespaces automatically.

1. If the CDB instance is open, then shut it down.
2. Start up the CDB instance in `OPEN UPGRADE` mode. For example:

```
STARTUP UPGRADE
```

3. In SQL\*Plus, ensure that the current container is the CDB root. For example, enter the following:

```
SHOW CON_NAME

CON_NAME
-----
CDB$ROOT
```

4. Query the current undo mode of the CDB:

```
SELECT PROPERTY_NAME, PROPERTY_VALUE FROM DATABASE_PROPERTIES WHERE
PROPERTY_NAME = 'LOCAL_UNDO_ENABLED';
```

5. To enable local undo, issue the following SQL statement:

```
ALTER DATABASE LOCAL UNDO ON;
```

6. Shut down and restart the CDB instance.
7. Optional: Manually create an undo tablespace in the PDB seed.

While Oracle Database creates an undo tablespace in the PDB seed automatically in local undo mode, you might want to control the size and configuration of the undo tablespace by creating an undo tablespace manually. To ensure the PDBs created from the PDB seed use the manually-created undo tablespace and not the automatically-created undo tablespace, you must set the `UNDO_TABLESPACE` initialization parameter to the manually-created undo tablespace, or drop the automatically-created undo tablespace.

- a. In SQL\*Plus, ensure that the current container is the root.
- b. Place the PDB seed in open read/write mode:

```
ALTER PLUGGABLE DATABASE PDB$SEED OPEN READ WRITE FORCE;
```

- c. Switch container to the PDB seed:

```
ALTER SESSION SET CONTAINER=PDB$SEED;
```

- d. Create an undo tablespace in the PDB seed. For example:

```
CREATE UNDO TABLESPACE seedundots1
  DATAFILE 'seedundotbs_1a.dbf'
  SIZE 10M AUTOEXTEND ON
  RETENTION GUARANTEE;
```

- e. Switch container to the root:

```
ALTER SESSION SET CONTAINER=CDB$ROOT;
```

- f. Place the PDB seed in open read-only mode:

```
ALTER PLUGGABLE DATABASE PDB$SEED OPEN READ ONLY FORCE;
```

### 13.4.3.3 Configuring a CDB to Use Shared Undo Mode

To change a CDB to use shared undo mode, use an `ALTER DATABASE LOCAL UNDO OFF` statement.

1. If the CDB instance is open, then shut it down.



2. Start up the CDB instance in `OPEN UPGRADE` mode. For example:

```
STARTUP UPGRADE
```

3. In SQL\*Plus, ensure that the current container is the CDB root. For example, enter the following:

```
SHOW CON_NAME
```

```
CON_NAME
```

```
-----
```

```
CDB$ROOT
```

4. Optionally, query the current undo mode of the CDB:

```
SELECT PROPERTY_NAME, PROPERTY_VALUE FROM DATABASE_PROPERTIES WHERE  
PROPERTY_NAME = 'LOCAL_UNDO_ENABLED' ;
```

5. To turn off local undo, issue the following SQL statement:

```
ALTER DATABASE LOCAL UNDO OFF ;
```

6. Shut down and restart the CDB instance.

When in shared undo mode, the CDB ignores any local undo tablespaces that were created when it was in local undo mode. Oracle recommends that you delete the unused local undo tablespaces.

## 13.4.4 Modifying the CDB Root Using ALTER DATABASE

To modify only the root of a CDB, use the `ALTER DATABASE` statement.

When the current container is the root, some `ALTER DATABASE` statements modify the root without directly modifying any of the PDBs. See the "Modify Root Only" column of [Table 13-3](#) for a list of these statements.

Some statements set the defaults for the PDBs in the CDB. You can overwrite these defaults for a PDB by using the `ALTER PLUGGABLE DATABASE` statement.

### Prerequisites

To modify the root, the current user must have the `ALTER DATABASE` privilege in the root.

### To modify the root:

1. In SQL\*Plus, ensure that the current container is the root.
2. Run an `ALTER DATABASE` statement with a clause that modifies the root.

The following examples modify the root.

A user whose current container is the root that is not explicitly assigned a tablespace uses the default permanent tablespace for the root. The tablespace specified in the `ALTER DATABASE` statement must exist in the root.

After executing this statement, the default type of subsequently created tablespaces in the root is bigfile. This setting is also the default for PDBs.

The tablespace or tablespace group specified in the `ALTER DATABASE` statement must exist in the root.

**Example 13-14 Changing the Default Permanent Tablespace for the Root**

This `ALTER DATABASE` statement uses a `DEFAULT TABLESPACE` clause to set the default permanent tablespace to `root_tbs` for the root.

```
ALTER DATABASE DEFAULT TABLESPACE root_tbs;
```

**Example 13-15 Bringing a Data File Online for the Root**

This `ALTER DATABASE` statement uses a `database_file_clause` to bring the `/u02/oracle/cdb_01.dbf` data file online.

```
ALTER DATABASE DATAFILE '/u02/oracle/cdb_01.dbf' ONLINE;
```

**Example 13-16 Changing the Default Tablespace Type for the Root**

This `ALTER DATABASE` statement uses a `SET DEFAULT TABLESPACE` clause to change the default tablespace type to `bigfile` for the root.

```
ALTER DATABASE SET DEFAULT BIGFILE TABLESPACE;
```

**Example 13-17 Changing the Default Temporary Tablespace for the Root**

This `ALTER DATABASE` statement uses a `DEFAULT TEMPORARY TABLESPACE` clause to set the default temporary tablespace to `root_temp` for the root.

```
ALTER DATABASE DEFAULT TEMPORARY TABLESPACE root_temp;
```

**See Also:**

- ["Modifying a PDB at the Database Level"](#)
- *Oracle Database SQL Language Reference*

## 13.4.5 Modifying the Open Mode of One or More PDBs

You can modify the open mode of a PDB by using the `ALTER PLUGGABLE DATABASE SQL` statement or the SQL\*Plus `STARTUP` command.

This section contains the following topics:

- [About the Open Mode of a PDB](#)  
A PDB can be in various modes.
- [Modifying the Open Mode of PDBs with ALTER PLUGGABLE DATABASE](#)  
You can modify the open mode of PDBs with the `ALTER PLUGGABLE DATABASE` statement with a `pdb_change_state` clause.
- [Modifying the Open Mode of PDBs with the SQL\\*Plus STARTUP Command](#)  
You can use the `STARTUP PLUGGABLE DATABASE` command to open a single PDB.

- [Preserving or Discarding the Open Mode of PDBs When the CDB Restarts](#)  
 You can preserve the open mode of one or more PDBs when the CDB restarts by using the `ALTER PLUGGABLE DATABASE SQL` statement with a `pdb_save_or_discard_state` clause.
- [Starting and Stopping PDBs in Oracle RAC](#)  
 Administering a pluggable database (PDB) involves a small subset of the tasks required to administer a non-CDB.

### 13.4.5.1 About the Open Mode of a PDB

A PDB can be in various modes.

The following table describes the possible PDB modes.

**Table 13-4 PDB Modes**

Mode	Description
OPEN READ WRITE	A PDB in open read/write mode allows queries and user transactions to proceed and allows users to generate redo logs.
OPEN READ ONLY	A PDB in open read-only mode allows queries but does not allow user changes.
OPEN MIGRATE	When a PDB is in open migrate mode, you can run database upgrade scripts on the PDB.  A PDB is in this mode after an <code>ALTER DATABASE OPEN UPGRADE</code> is run.
MOUNTED	When a PDB is in mounted mode, it behaves like a non-CDB in mounted mode. It does not allow changes to any objects, and it is accessible only to database administrators. It cannot read from or write to data files. Information about the PDB is removed from memory caches. Cold backups of the PDB are possible.

The open read/write, read-only, and migrate modes can be restricted to users with `RESTRICTED SESSION` privilege in the PDB.

While a PDB is in mounted or read-only mode, database administrators can create, modify, or drop common users and roles in the CDB. The CDB applies these changes to the PDB when its open mode is changed to open in read/write mode. Before the changes are applied, descriptions of common users and roles in the PDB might be different from the descriptions in the rest of the CDB.

When a PDB is opened, Oracle Database checks the compatibility of the PDB with the CDB. Each compatibility violation is either a warning or an error. If a compatibility violation is a warning, then the warning is recorded in the alert log, but the PDB is opened normally without displaying a warning message. If a compatibility violation is an error, then a message is displayed when the PDB is opened stating that the PDB was altered with errors, and the errors are recorded in the alert log. You must correct the condition that caused each error. When there are errors, the PDB is opened, but access to the PDB is limited to users with `RESTRICTED SESSION` privilege so that the compatibility violations can be addressed. You can view descriptions of violations by querying `PDB_PLUG_IN_VIOLATIONS` view.

This section contains the following topics:

- [About Modifying the Open Mode of PDBs with ALTER PLUGGABLE DATABASE](#)  
When the current container is the root, an `ALTER PLUGGABLE DATABASE` statement with a `pdb_change_state` clause modifies the open mode of the specified PDBs.
- [About Modifying the Open Mode of PDBs with the SQL\\*Plus STARTUP Command](#)  
When the current container is the root, the `STARTUP PLUGGABLE DATABASE` command can open a single PDB.

 **See Also:**

- ["Modifying the Open Mode of One or More PDBs"](#) for information about modifying the open mode of one or more PDBs when the current container is the root
- ["Modifying a PDB with the ALTER PLUGGABLE DATABASE Statement"](#) for information about modifying the open mode of a PDB when the current container is the PDB
- ["Shutting Down a CDB Instance"](#)
- ["Modifying a PDB at the Database Level"](#) for information about modifying other attributes of a PDB

### 13.4.5.1.1 About Modifying the Open Mode of PDBs with ALTER PLUGGABLE DATABASE

When the current container is the root, an `ALTER PLUGGABLE DATABASE` statement with a `pdb_change_state` clause modifies the open mode of the specified PDBs.

The following table describes the clauses of the `ALTER PLUGGABLE DATABASE` statement that modify the mode of a PDB.

**Table 13-5 ALTER PLUGGABLE DATABASE Clauses That Modify the Mode of a PDB**

Clause	Description
OPEN READ WRITE [RESTRICTED] [FORCE]	<p>Opens the PDB in read/write mode.</p> <p>When <code>RESTRICTED</code> is specified, the PDB is accessible only to users with <code>RESTRICTED SESSION</code> privilege in the PDB. All sessions connected to the PDB that do not have <code>RESTRICTED SESSION</code> privilege on it are terminated, and their transactions are rolled back.</p> <p>When <code>FORCE</code> is specified, the statement opens a PDB that is currently closed and changes the open mode of a PDB that is in open read-only mode.</p>

**Table 13-5 (Cont.) ALTER PLUGGABLE DATABASE Clauses That Modify the Mode of a PDB**

Clause	Description
OPEN READ ONLY[RESTRICTED] [FORCE]	Opens the PDB in read-only mode.  When RESTRICTED is specified, the PDB is accessible only to users with RESTRICTED SESSION privilege in the PDB. All sessions connected to the PDB that do not have RESTRICTED SESSION privilege on it are terminated.  When FORCE is specified, the statement opens a PDB that is currently closed and changes the open mode of a PDB that is in open read/write mode.
OPEN UPGRADE [RESTRICTED]	Opens the PDB in migrate mode.  When RESTRICTED is specified, the PDB is accessible only to users with RESTRICTED SESSION privilege in the PDB.
CLOSE [IMMEDIATE] ABORT]	Places the PDB in mounted mode.  The CLOSE statement is the PDB equivalent of the SQL*Plus SHUTDOWN command. If you do not specify IMMEDIATE or ABORT, then the PDB is shut down with the normal mode.  When IMMEDIATE is specified, this statement is the PDB equivalent of the SQL*Plus SHUTDOWN command with the immediate mode.  When ABORT is specified, the PDB is forcefully closed. For a single-instance CDB, PDB media recovery is required when you specify SHUTDOWN ABORT. For an Oracle Real Application Clusters (Oracle RAC) CDB, PDB media recovery is required if the SHUTDOWN ABORT command closes the last open instance.

When you issue an ALTER PLUGGABLE DATABASE OPEN statement, READ WRITE is the default unless a PDB being opened belongs to a CDB that is used as a physical standby database, in which case READ ONLY is the default.

You can specify which PDBs to modify in the following ways:

- List one or more PDBs.
- Specify ALL to modify all PDBs.
- Specify ALL EXCEPT to modify all PDBs, except for the PDBs listed.

#### The *services* Clause

You can use the *services* clause to specify the services that are started when a single PDB is opened in the following ways:

- List one or more services in the *services* clause in the following form:

```
SERVICES = ('service_name' [, 'service_name'] ... )
```

- Specify ALL in the *services* clause to start all PDB's services, as in the following example:

```
SERVICES = ALL
```

- Specify `ALL EXCEPT` in the `services` clause to start all PDB's services, except for the services listed, in the following form:

```
SERVICES = ALL EXCEPT('service_name' [, 'service_name'] ... )
```

- Specify `NONE` in the `services` clause to start only the PDB's default service and none of the other PDB's services, as in the following example:

```
SERVICES = NONE
```

`NONE` is the default setting for the `services` clause. A PDB's default service is always started, regardless of the setting for the `services` clause.

### The `instances` Clause

For an Oracle Real Application Clusters (Oracle RAC) CDB, you can use the `instances` clause to specify the instances on which the PDB is modified in the following ways:

- List one or more instances in the `instances` clause in the following form:

```
INSTANCES = ('instance_name' [, 'instance_name'] ... )
```

- Specify `ALL` in the `instances` clause to modify the PDB in all running instances, as in the following example:

```
INSTANCES = ALL
```

- Specify `ALL EXCEPT` in the `instances` clause to modify the PDB in all instances, except for the instances listed, in the following form:

```
INSTANCES = ALL EXCEPT('instance_name' [, 'instance_name'] ... )
```

Also, when you are closing a PDB in an Oracle RAC CDB, you can use the `relocate` clause, which includes the following options:

- Specify `NORELOCATE`, the default, to close the PDB in the current instance.
- Specify `RELOCATE TO` and specify an instance name to reopen the PDB in the specified instance.
- Specify `RELOCATE` to reopen the PDB on a different instance that is selected by Oracle Database.

#### Note:

If both the `services` clause and the `instances` clause are specified in the same `ALTER PLUGGABLE DATABASE` statement, then the specified services are started on the specified instances.

### The `relocate` Clause

When you are closing a PDB in an Oracle RAC CDB, you can use the `relocate` clause, which includes the following options:

- Specify `NORELOCATE`, the default, to close the PDB in the current instance.
- Specify `RELOCATE TO` and specify an instance name to reopen the PDB in the specified instance.
- Specify `RELOCATE` to reopen the PDB on a different instance that is selected by Oracle Database.

To modify the open mode of PDBs with the `ALTER PLUGGABLE DATABASE` statement, the following prerequisites must be met:

- The current user must have `SYSDBA`, `SYSOPER`, `SYSBACKUP`, or `SYSDG` administrative privilege, and the privilege must be either commonly granted or locally granted in the PDB. The user must exercise the privilege using `AS SYSDBA`, `AS SYSOPER`, `AS SYSBACKUP`, or `AS SYSDG`, respectively, at connect time.
- When `RESTRICTED SESSION` is enabled, `RESTRICTED` must be specified when a PDB is opened.
- In an Oracle RAC CDB, if a PDB is open in one or more Oracle RAC instances, then it can be opened in additional instances, but it must be opened in the same mode as in the instances in which it is already open. A PDB can be closed in some instances and opened on others.

#### Summary of Requirements for the `ALTER PLUGGABLE DATABASE` Statement

To modify the open mode of PDBs with the `ALTER PLUGGABLE DATABASE` statement, the following prerequisites must be met:

- The current user must have `SYSDBA`, `SYSOPER`, `SYSBACKUP`, or `SYSDG` administrative privilege, and the privilege must be either commonly granted or locally granted in the PDB. The user must exercise the privilege using `AS SYSDBA`, `AS SYSOPER`, `AS SYSBACKUP`, or `AS SYSDG`, respectively, at connect time.
- When `RESTRICTED SESSION` is enabled, `RESTRICTED` must be specified when a PDB is opened.
- In an Oracle RAC CDB, if a PDB is open in one or more Oracle RAC instances, then it can be opened in additional instances, but it must be opened in the same mode as in the instances in which it is already open. A PDB can be closed in some instances and opened on others.

To place PDBs in a target mode with the `ALTER PLUGGABLE DATABASE` statement, you must meet the requirements described in the following table.

**Table 13-6 Modifying the Open Mode of PDBs with `ALTER PLUGGABLE DATABASE`**

Target Mode of PDBs	ALL Keyword Included	FORCE Keyword Included	Required Mode for the Root	Required Mode for Each PDB Being Modified
Read/write	Yes	Yes	Read/write	Mounted, read-only, or read/write
Read/write	Yes	No	Read/write	Mounted or read/write
Read/write	No	Yes	Read/write	Mounted, read-only, or read/write
Read/write	No	No	Read/write	Mounted

Table 13-6 (Cont.) Modifying the Open Mode of PDBs with ALTER PLUGGABLE DATABASE

Target Mode of PDBs	ALL Keyword Included	FORCE Keyword Included	Required Mode for the Root	Required Mode for Each PDB Being Modified
Read-only	Yes	Yes	Read-only or read/write	Mounted, read-only, or read/write
Read-only	Yes	No	Read-only or read/write	Mounted or read-only
Read-only	No	Yes	Read-only or read/write	Mounted, read-only, or read/write
Read-only	No	No	Read-only or read/write	Mounted
Migrate	Yes	Not applicable	Read-only or read/write	Mounted
Migrate	No	Not applicable	Read-only or read/write	Mounted
Mounted	Yes	Not applicable	Read-only or read/write	Mounted, read-only, migrate, or read/write
Mounted	No	Not applicable	Read-only or read/write	Read-only, migrate, or read/write

 **Note:**

You can also modify the open mode of a PDB when the current container is the PDB.

 **See Also:**

- ["Modifying a PDB with the ALTER PLUGGABLE DATABASE Statement"](#)
- ["Modifying the Open Mode of PDBs with ALTER PLUGGABLE DATABASE"](#)
- *Oracle Database Administrator's Guide* for more information about shutting down a database

### 13.4.5.1.2 About Modifying the Open Mode of PDBs with the SQL\*Plus STARTUP Command

When the current container is the root, the `STARTUP PLUGGABLE DATABASE` command can open a single PDB.

Use the following options of the `STARTUP PLUGGABLE DATABASE` command to open a PDB:

- `FORCE`

Closes an open PDB before re-opening it in read/write mode. When this option is specified, no other options are allowed.



- **RESTRICT**  
 Enables only users with the `RESTRICTED SESSION` system privilege in the PDB to access the PDB.  
 If neither `OPEN READ WRITE` nor `OPEN READ ONLY` is specified, then the PDB is opened in read-only mode when the CDB to which it belongs is a physical standby database. Otherwise, the PDB is opened in read/write mode.
- **OPEN *open\_pdb\_options***  
 Opens the PDB in either read/write mode or read-only mode. You can specify `OPEN READ WRITE` or `OPEN READ ONLY`. When you specify `OPEN` without any other options, `READ WRITE` is the default.

The following prerequisites must be met:

- The current user must have `SYSDBA`, `SYSOPER`, `SYSBACKUP`, or `SYSDG` administrative privilege, and the privilege must be either commonly granted or locally granted in the PDB. The user must exercise the privilege using `AS SYSDBA`, `AS SYSOPER`, `AS SYSBACKUP`, or `AS SYSDG`, respectively, at connect time.
- When `RESTRICTED SESSION` is enabled, `RESTRICT` must be specified when a PDB is opened.

In addition, to place PDBs in a target mode with the `STARTUP PLUGGABLE DATABASE` command, you must meet the requirements described in the following table.

**Table 13-7 Modifying the Open Mode of a PDB with STARTUP PLUGGABLE DATABASE**

Target Mode of the PDB	FORCE Option Included	Required Mode for the Root	Required Mode of the PDB Being Modified
Read/write	Yes	Read/write	Mounted, read-only, or read/write
Read/write	No	Read/write	Mounted
Read-only	No	Read-only or read/write	Mounted

 **Note:**

You can also use the `STARTUP` command to modify the open mode of a PDB when the current container is the PDB.

 **See Also:**

- ["Starting Up a PDB Using the STARTUP Command"](#)
- ["Modifying the Open Mode of PDBs with the SQL\\*Plus STARTUP Command"](#)

## 13.4.5.2 Modifying the Open Mode of PDBs with ALTER PLUGGABLE DATABASE

You can modify the open mode of PDBs with the `ALTER PLUGGABLE DATABASE` statement with a `pdb_change_state` clause.

**To modify the open mode:**

1. In SQL\*Plus, ensure that the current container is the root.  
See "[About Container Access in a CDB](#)".
2. Run an `ALTER PLUGGABLE DATABASE` statement with a `pdb_change_state` clause.

### Example 13-18 Changing the Open Mode of Listed PDBs

This statement changes the open mode of PDBs `salespdb` and `hrpdb` to open in read/write mode.

```
ALTER PLUGGABLE DATABASE salespdb, hrpdb
OPEN READ WRITE;
```

This statement changes the open mode of PDB `salespdb` to open in read-only mode. `RESTRICTED` specifies that the PDB is accessible only to users with `RESTRICTED SESSION` privilege in the PDB.

```
ALTER PLUGGABLE DATABASE salespdb
OPEN READ ONLY RESTRICTED;
```

This statement changes the open mode of PDB `salespdb` to open in migrate mode:

```
ALTER PLUGGABLE DATABASE salespdb
OPEN UPGRADE;
```

### Example 13-19 Changing the Open Mode of All PDBs

Run the following query to display the open mode of each PDB associated with a CDB:

```
SELECT NAME, OPEN_MODE FROM V$PDBS WHERE CON_ID > 2;
```

NAME	OPEN_MODE
HRPDB	READ WRITE
SALESPDB	MOUNTED
DWPDB	MOUNTED

Notice that `hrpdb` is already in read/write mode. To change the open mode of `salespdb` and `dwpdb` to open in read/write mode, use the following statement:

```
ALTER PLUGGABLE DATABASE ALL
OPEN READ WRITE;
```

The `hrpdb` PDB is not modified because it is already in open read/write mode. The statement does not return an error because two PDBs are in mounted mode and one PDB (`hrpdb`) is in the specified mode (read/write). Similarly, the statement does not return an error if all PDBs are in mounted mode.

However, if any PDB is in read-only mode, then the statement returns an error. To avoid an error and open all PDBs in the CDB in read/write mode, specify the `FORCE` keyword:

```
ALTER PLUGGABLE DATABASE ALL  
OPEN READ WRITE FORCE;
```

With the `FORCE` keyword included, all PDBs are opened in read/write mode, including PDBs in read-only mode.

### Example 13-20 Changing the Open Mode of All PDBs Except for Listed Ones

This statement changes the mode of all PDBs except for `salespdb` and `hrpdb` to mounted mode.

```
ALTER PLUGGABLE DATABASE ALL EXCEPT salespdb, hrpdb  
CLOSE IMMEDIATE;
```

#### Note:

An `ALTER PLUGGABLE DATABASE` statement modifying the open mode of a PDB is instance-specific. Therefore, if this statement is issued when connected to an Oracle RAC instance, then it affects the open mode of the PDB only in that instance.

#### See Also:

- ["About Modifying the Open Mode of PDBs with ALTER PLUGGABLE DATABASE"](#)
- ["Modifying a PDB at the Database Level"](#) for information about modifying the other attributes of a PDB
- *Oracle Database Administrator's Guide* for information about database modes and their uses
- *Oracle Database SQL Language Reference*
- *Oracle Database Concepts* for more information about shutdown modes

### 13.4.5.3 Modifying the Open Mode of PDBs with the SQL\*Plus STARTUP Command

You can use the `STARTUP PLUGGABLE DATABASE` command to open a single PDB.

To modify a PDB with the `STARTUP PLUGGABLE DATABASE` command:

1. In SQL\*Plus, ensure that the current container is the root.  
See "[About Container Access in a CDB](#)".
2. Run the `STARTUP PLUGGABLE DATABASE` command.

 **Note:**

When the current container is the root, the SQL\*Plus `SHUTDOWN` command always shuts down the CDB instance. It cannot be used to close individual PDBs.

**Example 13-21 Opening a PDB in Read/Write Mode with the STARTUP Command**

```
STARTUP PLUGGABLE DATABASE hrpdb OPEN
```

**Example 13-22 Opening a PDB in Read/Write Restricted Mode with the STARTUP Command**

```
STARTUP PLUGGABLE DATABASE hrpdb RESTRICT
```

**Example 13-23 Opening a PDB in Read-Only Restricted Mode with the STARTUP Command**

```
STARTUP PLUGGABLE DATABASE hrpdb OPEN READ ONLY RESTRICT
```

**Example 13-24 Opening a PDB in Read-Only Mode with the STARTUP Command**

```
STARTUP PLUGGABLE DATABASE hrpdb OPEN READ ONLY
```

**Example 13-25 Opening a PDB in Read/Write Mode with the STARTUP Command and the FORCE Option**

This example assumes that the `hrpdb` PDB is currently open. The `FORCE` option closes the PDB and then opens it in the read/write mode.

```
STARTUP PLUGGABLE DATABASE hrpdb FORCE
```

 **See Also:**

- ["About Modifying the Open Mode of PDBs with the SQL\\*Plus STARTUP Command"](#)
- ["Starting Up and Shutting Down a PDB"](#) for information about using the STARTUP or SHUTDOWN command when the current container is a PDB
- *Oracle Database Administrator's Guide*
- *SQL\*Plus User's Guide and Reference*

### 13.4.5.4 Preserving or Discarding the Open Mode of PDBs When the CDB Restarts

You can preserve the open mode of one or more PDBs when the CDB restarts by using the ALTER PLUGGABLE DATABASE SQL statement with a *pdb\_save\_or\_discard\_state* clause.

You can do this in the following way:

- Specify `SAVE STATE` to preserve the PDBs' mode when the CDB is restarted.  
For example, if a PDB is in open read/write mode before the CDB is restarted, then the PDB is in open read/write mode after the CDB is restarted; if a PDB is in mounted mode before the CDB is restarted, then the PDB is in mounted mode after the CDB is restarted.
- Specify `DISCARD STATE` to ignore the PDBs' open mode when the CDB is restarted.

When `DISCARD STATE` is specified for a PDB, the PDB is always mounted after the CDB is restarted.

You can specify which PDBs to modify in the following ways:

- List one or more PDBs.
- Specify `ALL` to modify all PDBs.
- Specify `ALL EXCEPT` to modify all PDBs, except for the PDBs listed.

For an Oracle RAC CDB, you can use the *instances* clause in the *pdb\_save\_or\_discard\_state* clause to specify the instances on which a PDB's open mode is preserved in the following ways:

- List one or more instances in the *instances* clause in the following form:

```
INSTANCES = ('instance_name' [, 'instance_name'] ... )
```

- Specify `ALL` in the *instances* clause to modify the PDB in all running instances, as in the following example:

```
INSTANCES = ALL
```

- Specify `ALL EXCEPT` in the `instances` clause to modify the PDB in all instances, except for the instances listed, in the following form:

```
INSTANCES = ALL EXCEPT('instance_name' [, 'instance_name'] ... )
```

For a PDB in an Oracle RAC CDB, `SAVE STATE` and `DISCARD STATE` only affect the mode of the current instance. They do not affect the mode of other instances, even if more than one instance is specified in the `instances` clause.

To issue an `ALTER PLUGGABLE DATABASE` SQL statement with a `pdb_save_or_discard_state` clause, the current user must have the `ALTER DATABASE` privilege in the root.

You can check the saved states for the PDBs in a CDB by querying the `DBA_PDB_SAVED_STATES` view.

#### To preserve or discard a PDB's open mode when the CDB restarts:

1. In SQL\*Plus, ensure that the current container is the root.  
See ["About Container Access in a CDB"](#).
2. Run an `ALTER PLUGGABLE DATABASE` statement with a `pdb_save_or_discard_state` clause.

The following examples either preserve or discard the open mode of one or more PDBs when the CDB restarts.

#### Example 13-26 Preserving the Open Mode of a PDB When the CDB Restarts

This statement preserves the open mode of the `salespdb` when the CDB restarts.

```
ALTER PLUGGABLE DATABASE salespdb SAVE STATE;
```

#### Example 13-27 Discarding the Open Mode of a PDB When the CDB Restarts

This statement discards the open mode of the `salespdb` when the CDB restarts.

```
ALTER PLUGGABLE DATABASE salespdb DISCARD STATE;
```

#### Example 13-28 Preserving the Open Mode of All PDBs When the CDB Restarts

This statement preserves the open mode of all PDBs when the CDB restarts.

```
ALTER PLUGGABLE DATABASE ALL SAVE STATE;
```

#### Example 13-29 Preserving the Open Mode of Listed PDBs When the CDB Restarts

This statement preserves the open mode of the `salespdb` and `hrpdb` when the CDB restarts.

```
ALTER PLUGGABLE DATABASE salespdb, hrpdb SAVE STATE;
```

**Example 13-30 Preserving the Open Mode of All PDBs Except for Listed Ones When the CDB Restarts**

This statement preserves the open mode of all PDBs except for `salespdb` and `hrpdb`.

```
ALTER PLUGGABLE DATABASE ALL EXCEPT salespdb, hrpdb SAVE STATE;
```

### 13.4.5.5 Starting and Stopping PDBs in Oracle RAC

Administering a pluggable database (PDB) involves a small subset of the tasks required to administer a non-CDB.

Administering an Oracle RAC-based multitenant container database (CDB) is similar to administering a non-CDB. The differences are that some administrative tasks apply to the entire CDB, some to the CDB root, and some to specific PDBs. In this subset of tasks, most are the same for a PDB and a non-CDB. There are some differences, however, such as when you modify the open mode of a PDB. Also, a PDB administrator is limited to managing a single PDB and is not affected by other PDBs in the CDB.

You manage PDBs in an Oracle RAC CDB by managing services. This is true regardless of whether the PDBs are policy managed or administrator managed. Assign one dynamic database service to each PDB to coordinate start, stop, and placement of PDBs across instances in a clustered container database.

For example, if you have a CDB called `raccont` with a policy-managed PDB called `spark` in a server pool called `prod`, then assign a service called `plug` to this database using the following command:

```
srvctl add service -db raccont -pdb spark -service plug -serverpool prod
```

The service `plug` is uniformly managed across all nodes in the server pool. If you want to have this service running as a singleton service in the same server pool, then use the `-cardinality singleton` parameter with the preceding command.

To open the PDB `spark`, you must start the service `plug` as follows:

```
srvctl start service -db raccont -service plug
```

To stop the service `plug`:

```
srvctl stop service -db raccont -service plug
```

The PDB `spark` remains open until you close the PDB using the SQL command `ALTER PLUGGABLE DATABASE PDB_NAME CLOSE IMMEDIATE`. You can check the status of the database using the `srvctl status service` command.

Because PDBs are managed using dynamic database services, typical Oracle RAC-based management practices apply. For this reason, if the service `plug` is in the online state when Oracle Clusterware is shut down on a server hosting this service, then the service is restored to its original state after the restart of Oracle Clusterware on this server. Thus, starting PDBs is automated as with any other Oracle RAC database.

 **Note:**

Unlike SQL\*Plus, SRVCTL operates on an entire cluster database. Starting a PDB using services therefore applies to multiple instances of the clustered CDB at the same time when the service is defined to run on multiple servers simultaneously and the current status of the cluster allows for this placement.

**Related Topics**

- *Oracle Real Application Clusters Administration and Deployment Guide*

## 13.5 Executing SQL in a Different Container

To execute SQL in a different container, use the `CONTAINERS` clause for DML or the `CONTAINER` clause for DDL.

This section contains the following topics:

- [Issuing DML Statements on a Container in a CDB](#)  
A DML (data manipulation language) statement issued in a CDB or application root can modify a different container in the CDB. In addition, you can specify a default container target for DML statements.
- [Executing DDL Statements in a CDB](#)  
In a CDB, you can execute a data definition language (DDL) statement in the current container or in all containers.
- [Running Oracle-Supplied SQL Scripts in a CDB](#)  
You can use the `catcon.pl` script to run Oracle-supplied SQL or SQL scripts within a CDB. You can run the script against any specified containers.
- [Executing Code in Containers Using the `DBMS\_SQL` Package](#)  
When you are executing PL/SQL code in a container in a CDB, and you want to execute one or more SQL statements in a different container, use the `DBMS_SQL` package to switch containers.

### 13.5.1 Issuing DML Statements on a Container in a CDB

A DML (data manipulation language) statement issued in a CDB or application root can modify a different container in the CDB. In addition, you can specify a default container target for DML statements.

This section contains the following topics:

- [About Issuing DML Statements on a Container in a CDB](#)  
DML statements can affect database objects in a specified container in a CDB.
- [Specifying the Default Container for DML Statements in a CDB](#)  
To specify the default container for DML statements in a CDB, issue the `ALTER DATABASE` statement with the `CONTAINERS DEFAULT TARGET` clause.

#### 13.5.1.1 About Issuing DML Statements on a Container in a CDB

DML statements can affect database objects in a specified container in a CDB.



The container is specified by container ID. Because the container ID can appear in more than one location, the database uses the following order of precedence:

1. The `CON_ID` specified in the `WHERE` clause of a DML statement
2. The `CONTAINERS_DEFAULT_TARGET` database property
3. The current container, which is either the CDB root or application root

In a CDB root or an application root, a DML statement that includes the `CONTAINERS` clause can modify a table or view in a single container in the CDB or application container. To use the `CONTAINERS` clause, specify the table or view being modified in the `CONTAINERS` clause and the container ID affected in the `WHERE` clause.

You can specify a target container in an `INSERT VALUES` statement by specifying a value for `CON_ID` in the `VALUES` clause. Also, you can specify a target container in an `UPDATE` or `DELETE` statement by specifying a `CON_ID` predicate in the `WHERE` clause. For example, the following DML statement updates the `sales.customers` table in the container with a `CON_ID` of 7:

```
UPDATE CONTAINERS(sales.customers) ctab
  SET ctab.city_name='MIAMI'
  WHERE ctab.CON_ID=7
  AND CUSTOMER_ID=3425;
```

The following restrictions apply to the `CONTAINERS` clause:

- The specified schema must exist both in the container specified by `CON_ID` and in the CDB or application root where the statement is executed.
- The value specified for the `CON_ID` in the `WHERE` clause must refer to a PDB, application root, or application PDB within the CDB.
- `INSERT as SELECT` statements where the target of the `INSERT` is in `CONTAINERS()` is not supported.
- A multitable `INSERT` statement where the target of the `INSERT` is in `CONTAINERS()` is not supported.
- DML statements using the `CONTAINERS` clause require that the database listener is configured using TCP (instead of IPC) and that the `PORT` and `HOST` values are specified for each target PDB using the `PORT` and `HOST` clauses, respectively.

### 13.5.1.2 Specifying the Default Container for DML Statements in a CDB

To specify the default container for DML statements in a CDB, issue the `ALTER DATABASE` statement with the `CONTAINERS DEFAULT TARGET` clause.

When a DML statement is issued in a CDB root without specifying containers in the `WHERE` clause, the DML statement affects the default container for the CDB. The default container can be any container in the CDB, including the CDB root, a PDB, an application root, or an application PDB. Only one default container is allowed.

The `CONTAINERS_DEFAULT_TARGET` database property sets the default container. By default, this property is not set. You can determine the default target containers for a CDB by running the following query:

```
SELECT PROPERTY_VALUE FROM DATABASE_PROPERTIES WHERE  
PROPERTY_NAME= 'CONTAINERS_DEFAULT_TARGET' ;
```

1. In SQL\*Plus, ensure that the current container is the CDB root or application root. The current user must have the commonly granted `ALTER DATABASE` privilege.
2. Run the `ALTER DATABASE` statement with the `CONTAINERS DEFAULT TARGET` clause.

### Example 13-31 Specifying the Default Container for DML Statements in a CDB

This example specifies that `PDB1` is the default container for DML statements in the CDB.

```
ALTER DATABASE CONTAINERS DEFAULT TARGET = (PDB1);
```

### Example 13-32 Clearing the Default Container

This example clears the default container setting. When it is not set, the default container is the CDB root.

```
ALTER DATABASE CONTAINERS DEFAULT TARGET = NONE;
```

## 13.5.2 Executing DDL Statements in a CDB

In a CDB, you can execute a data definition language (DDL) statement in the current container or in all containers.

This section contains the following topics:

- [About Executing DDL Statements in a CDB](#)  
In a CDB, some DDL statements can apply to all containers or to the current container only.
- [Executing a DDL Statement in the Current Container](#)  
Specify `CURRENT` in the `CONTAINER` clause of a DDL statement to execute the statement in the current container.
- [Executing a DDL Statement in All Containers in a CDB](#)  
Specify `ALL` in the `CONTAINER` clause of a DDL statement to execute the statement in all containers in a CDB.

### 13.5.2.1 About Executing DDL Statements in a CDB

In a CDB, some DDL statements can apply to all containers or to the current container only.

To specify which containers are affected, use the `CONTAINER` clause:

```
CONTAINER = { CURRENT | ALL }
```

The following settings are possible:

- `CURRENT` means that the statement applies only to the current container.
- `ALL` means that the statement applies to all containers in the CDB, including the root and all PDBs.

The following restrictions apply to the `CONTAINER` clause in DDL statements:

- The restrictions described in "[About the Current Container](#)".
- You can use the `CONTAINER` clause only with the DDL statements listed in [Table 13-8](#).

**Table 13-8 DDL Statements and the CONTAINER Clause in a CDB**

DDL Statement	CONTAINER = CURRENT	CONTAINER = ALL
CREATE USER	Creates a local user in the current PDB.	Creates a common user.
ALTER USER	Alters a local user in the current PDB.	Alters a common user.
CREATE ROLE	Creates a local role in the current PDB.	Creates a common role.
GRANT	Grants a privilege in the local container to a local user, common user, or local role.  The <code>SET CONTAINER</code> privilege can be granted to a user-created common user in the current PDB.	Grants a system privilege or object privilege on a common object to a common user or common role. The specified privilege is granted to the user or role across the entire CDB.
REVOKE	Revokes a privilege in the local container from a local user, common user, or local role.  This statement can revoke only a privilege granted with <code>CURRENT</code> specified in the <code>CONTAINER</code> clause from the specified user or role in the local container. The statement does not affect privileges granted with <code>ALL</code> specified in the <code>CONTAINER</code> clause.  The <code>SET CONTAINER</code> privilege can be revoked from a user-created common user in the current PDB.	Revokes a system privilege or object privilege on a common object from a common user or common role. The specified privilege is revoked from the user or role across the entire CDB.  This statement can revoke only a privilege granted with <code>ALL</code> specified in the <code>CONTAINER</code> clause from the specified common user or common role. The statement does not affect privileges granted with <code>CURRENT</code> specified in the <code>CONTAINER</code> clause. However, any privileges granted locally that depend on the privilege granted commonly that is being revoked are also revoked.

All other DDL statements apply to the current container only.

In addition to the usual rules for user, role, and profile names, the following rules and best practices apply when you create a user, role, or profile in a CDB:

- It is best practice for common user, role, and profile names to start with a prefix to avoid naming conflicts between common users, roles, and profiles and local users, roles, and profiles. You specify this prefix with the `COMMON_USER_PREFIX` initialization parameter in the CDB root. By default, the prefix is `C##` or `c##` in the CDB root.

- In an application container, it is best practice for application common user, role, and profile names to start with a prefix to avoid naming conflicts between application common users, roles, and profiles and local users, roles, and profiles. You specify this prefix with the `COMMON_USER_PREFIX` initialization parameter in the application root. By default, the prefix is `NULL` in an application root.
- When the `COMMON_USER_PREFIX` initialization parameter is set in an application root, the setting applies to the application common user, role, and profile names in the application container. The prefix can be different in the CDB root and in an application root, and the prefix can be different in different application containers.
- Common user, role, and profile names must consist only of ASCII characters. This restriction does not apply to application common user, role, and profile names.
- Local user, role, and profile names cannot start with the prefix specified for common users with the `COMMON_USER_PREFIX` initialization parameter.
- Local user, role, and profile names cannot start with `C##` or `c##`.
- Regardless of the value of `COMMON_USER_PREFIX` in the CDB root, application common user, role, and profile names cannot start with `C##` or `c##`.
- Application common user, role, and profile names cannot start with the prefix specified for common users with the `COMMON_USER_PREFIX` initialization parameter.

 **See Also:**

- ["Modifying a CDB with ALTER SYSTEM"](#) for information about using the `ALTER SYSTEM` statement in a CDB
- *Oracle Database SQL Language Reference*
- *Oracle Database Concepts*
- *Oracle Database Security Guide* for more information about managing users in a CDB
- *Oracle Database Reference* for more information about the `COMMON_USER_PREFIX` initialization parameter

### 13.5.2.2 Executing a DDL Statement in the Current Container

Specify `CURRENT` in the `CONTAINER` clause of a DDL statement to execute the statement in the current container.

The supported DDL statements are listed in [Table 13-8](#).

The current user must be granted the required privileges to execute the DDL statement in the current container. For example, to create a user, the current user must be granted the `CREATE USER` system privilege in the current container.

To execute a DDL statement in the current container:

1. In SQL\*Plus, access a container.  
See ["Accessing a Container in a CDB with SQL\\*Plus"](#).
2. Execute the DDL statement with `CONTAINER` set to `CURRENT`.

A local user's user name cannot start with the prefix specified by the `COMMON_USER_PREFIX` initialization parameter. By default, in the CDB root, the prefix is `C##` or `c##`. An application root can specify its own prefix for an application container. In addition, a common user's name must consist only of ASCII characters. The specified tablespace must exist in the PDB.

### Example 13-33 Creating Local User in a PDB

This example creates the local user `testpdb` in the current PDB.

```
CREATE USER testpdb IDENTIFIED BY password
  DEFAULT TABLESPACE pdb1_tbs
  QUOTA UNLIMITED ON pdb1_tbs
  CONTAINER = CURRENT;
```

## 13.5.2.3 Executing a DDL Statement in All Containers in a CDB

Specify `ALL` in the `CONTAINER` clause of a DDL statement to execute the statement in all containers in a CDB.

The supported DDL statements are listed in [Table 13-8](#).

The following prerequisites must be met:

- The current user must be a common user.
- The current user must be granted the required privileges commonly to execute the DDL statement. For example, to create a user, the current user must be granted the `CREATE USER` system privilege commonly.

To execute a DDL statement in all containers in a CDB:

1. In SQL\*Plus, ensure that the current container is the root.  
See "[About Container Access in a CDB](#)".
2. Execute the DDL statement with `CONTAINER` set to `ALL`.

A common user's user name must start with the prefix specified by the `COMMON_USER_PREFIX` initialization parameter. By default, in the CDB root, the prefix is `C##` or `c##`. An application root can specify its own prefix for an application container. In addition, a common user's name must consist only of ASCII characters. The specified tablespace must exist in the root and in all PDBs.

### Example 13-34 Creating Common User in a CDB

This example creates the common user `c##testcdb`.

```
CREATE USER c##testcdb IDENTIFIED BY password
  DEFAULT TABLESPACE cdb_tbs
  QUOTA UNLIMITED ON cdb_tbs
  CONTAINER = ALL;
```

## 13.5.3 Running Oracle-Supplied SQL Scripts in a CDB

You can use the `catcon.pl` script to run Oracle-supplied SQL or SQL scripts within a CDB. You can run the script against any specified containers.

This section contains the following topics:

- [About Running Oracle-Supplied SQL Scripts in a CDB](#)  
In a CDB, the `catcon.pl` script is the best way to run SQL scripts and SQL statements.
- [Syntax and Parameters for `catcon.pl`](#)  
The `catcon.pl` script is a Perl script that must be run at an operating system prompt.
- [Running the `catcon.pl` Script](#)  
Examples illustrate running the `catcon.pl` script.

### 13.5.3.1 About Running Oracle-Supplied SQL Scripts in a CDB

In a CDB, the `catcon.pl` script is the best way to run SQL scripts and SQL statements.

An Oracle Database installation includes several SQL scripts. These scripts perform operations such as creating data dictionary views and installing options.

The `catcon.pl` script can run scripts in the root and in specified PDBs in the correct order, and it generates log files that you can view to confirm that the SQL script or SQL statement did not generate unexpected errors. It also starts multiple processes and assigns new scripts to them as they finish running scripts previously assigned to them.

#### Note:

- Unless you exclude the PDB seed when you run `catcon.pl`, the SQL script or SQL statement is run on the PDB seed.
- You can use the `catcon.pl` script to run scripts on both CDBs and non-CDBs.

### 13.5.3.2 Syntax and Parameters for `catcon.pl`

The `catcon.pl` script is a Perl script that must be run at an operating system prompt.

The `catcon.pl` script has the following syntax and parameters:

```
$ORACLE_HOME/perl/bin/perl $ORACLE_HOME/rdbms/admin/catcon.pl
[--usr username[/password]] [--int_usr username[/password]] [--script_dir
directory]
[--log_dir directory] [{--incl_con|--excl_con} container] [--echo] [--
spool]
[--error_logging { ON | errorlogging-table-other-than-SPERRORLOG } ] [--
app_con application_root]
[--no_set_errlog_ident] [--diag] [-ignore_unavailable_pdb] [--verbose] [--
force_pdb_mode pdb_mode]
[--recover] --log_file_base log_file_name_base
-- { SQL_script [arguments] | --x'SQL_statement' }
```

Ensure that `--x SQL_statement` is preceded by `--` if it follows any single-letter parameter. If `--x SQL_statement` is preceded by a script name or another `--x SQL_statement`, then do not precede it with `--`. Also, note that the SQL statement must be inside single quotation marks.

Command line parameters to SQL scripts can be introduced using `--p`. Interactive (or secret) parameters to SQL scripts can be introduced using `--P`.

To view the help for the `catcon.pl` script, change directories to `$ORACLE_HOME/perl/bin/`, and then run the following command:

```
perl $ORACLE_HOME/rdbms/admin/catcon.pl --help
```

[Table 13-9](#) describes the `catcon.pl` parameters. A parameter is optional unless it is indicated that it is required.

The short parameter names in the following table are for backward compatibility. Some parameters do not have short names.

**Table 13-9 catcon.pl Parameters**

Parameter	Description
<code>--usr</code> Short name: <code>-u</code>	Specifies the user name and password to connect to the root and the specified PDBs. Specify a common user with the required privileges to run the SQL script or the SQL statement. The default is <code>/ AS SYSDBA</code> . If no password is supplied, then <code>catcon.pl</code> prompts for a password.
<code>--int_usr</code> Short name: <code>-U</code>	Specifies the user name and password to connect to the root and the specified PDBs. Specify a common user with the required privileges to perform internal tasks, such as querying CDB metadata. The default is <code>/ AS SYSDBA</code> . If no password is supplied, then <code>catcon.pl</code> prompts for a password.
<code>--script_dir</code> Short name: <code>-d</code>	Directory that contains the SQL script. The default is the current directory.
<code>--log_dir</code> Short name: <code>-l</code>	Directory into which <code>catcon.pl</code> writes log files. The default is the current directory.
<code>{--incl_con --excl_con}</code> Short names: <code>{-c -C}</code>	The containers in which the SQL script is run or is not run. The <code>--incl_con</code> parameter lists the containers in which the SQL script is run. The <code>--excl_con</code> parameter lists the containers in which the SQL script is not run. Specify containers in a space-delimited list of PDB names enclosed in single quotation marks. The <code>--incl_con</code> and <code>--excl_con</code> parameters are mutually exclusive. When this parameter is used, the <code>--app_con</code> parameter cannot be used.
<code>--echo</code> Short name: <code>-e</code>	Sets echo ON while running the script. The default is echo OFF.

**Table 13-9 (Cont.) catcon.pl Parameters**

Parameter	Description
--spool Short name: -s	Spools the output of every script into a file with the following name:  <i>log-file-name-base_script-name-without-extension_[container-name-if-any].default-extension</i>
--error_logging Short name: -E	When set to ON, the default error logging table is used. ON is the default setting. When set to ON, errors are written to the table SPERRORLOG in the current schema in each container in which the SQL script runs. If this table does not exist in a container, then it is created automatically.  When a table other than SPERRORLOG is specified, errors are written to the specified table. The table must exist in each container in which the SQL script runs, and the current user must have the necessary privileges to perform DML operations on the table in each of these containers.  See <i>SQL*Plus User's Guide and Reference</i> for more information about the error logging table.
--app_con Short name: -F	Specify an application root. The scripts are run in the application root and in the application PDBs that are plugged into the application root.  When this parameter is used, the --incl_con and --excl_con parameters cannot be used.
--no_set_errlog_identifier Short name: -I	Do not issue a SET ERRORLOGGING identifier. This option is intended for cases in which the SET ERRORLOGGING identifier is already set and should not be overwritten.
--diag Short name: -g	Turns on the generation of debugging information.
--verbose Short name: -v	Turns on verbose output.
--ignore_unavailable_pdb Short name: -f	Ignore PDBs that are closed or, if the --incl_con or --excl_con option is used, do not exist and process only open PDBs that were specified explicitly or implicitly.  When this option is not specified and some specified PDBs do not exist or are not open, an error is returned and none of the containers are processed.



**Table 13-9 (Cont.) catcon.pl Parameters**

Parameter	Description
<code>--force_pdb_mode</code>	<p>The required open mode for all PDBs against which the scripts are run. Specify one of the following values:</p> <ul style="list-style-type: none"> <li>• UNCHANGED</li> <li>• READ WRITE</li> <li>• READ ONLY</li> <li>• UPGRADE</li> <li>• DOWNGRADE</li> </ul> <p>When a value other than UNCHANGED is specified, all of the PDBs against which the script is run are changed to the specified open mode. If a PDB is open in a different mode, then the PDB is closed and re-opened in the specified mode. After all of the scripts are run, each PDB is restored to its original open mode.</p> <p>When UNCHANGED, the default, is specified, the open mode of the PDBs is not changed.</p>
<code>--recover</code> Short name: <code>-R</code>	Causes <code>catcon.pl</code> to attempt to recover if a SQL*Plus process that it spawned ends unexpectedly. When this parameter is not specified, <code>catcon.pl</code> does not attempt to recover the process and closes.
<code>--log_file_base</code> Short name: <code>-b</code>	(Required) The base name for log file names.

### 13.5.3.3 Running the catcon.pl Script

Examples illustrate running the `catcon.pl` script.

If a SQL script or SQL statement run by `catcon.pl` performs data manipulation language (DML) or data definition language (DDL) operations, then the containers being modified must be in read/write mode.

**To run the catcon.pl script:**

1. Open a command line prompt.
2. Run the `catcon.pl` script and specify one or more SQL scripts or SQL statements:

```
cd $ORACLE_HOME/perl/bin/
perl $ORACLE_HOME/rdbms/admin/catcon.pl parameters SQL_script
perl $ORACLE_HOME/rdbms/admin/catcon.pl parameters -- --xSQL_statement
```

#### **Example 13-35 Running the catblock.sql Script in All Containers in a CDB**

The following example runs the `catblock.sql` script in all of the containers of a CDB.

```
$ORACLE_HOME/perl/bin/perl $ORACLE_HOME/rdbms/admin/catcon.pl --usr SYS
--script_dir $ORACLE_HOME/rdbms/admin --log_file_base catblock_output
catblock.sql
```

The following parameters are specified:

- The `--usr` parameter specifies that `SYS` user runs the script in each container.

- The `--script_dir` parameter specifies that the SQL script is in the `$ORACLE_HOME/rdbms/admin` directory.
- The `--log_file_base` parameter specifies that the base name for log file names is `catblock_output`.

Default parameter values are used for all other parameters. Neither the `--incl_con` nor the `--excl_con` parameter is specified. Therefore, `catcon.pl` runs the script in all containers by default.

### Example 13-36 Running the `catblock.sql` Script in Specific PDBs

The following example runs the `catblock.sql` script in the `hrpdb` and `salespdb` PDBs in a CDB.

```
$ORACLE_HOME/perl/bin/perl $ORACLE_HOME/rdbms/admin/catcon.pl --usr SYS --
int_usr SYS
--script_dir $ORACLE_HOME/rdbms/admin --log_dir '/disk1/script_output' --
incl_con 'HRPDB SALESPDB'
--log_file_base catblock_output catblock.sql
```

The following parameters are specified:

- The `--usr` parameter specifies that `SYS` user runs the script in each container.
- The `--int_usr` parameter specifies that `SYS` user performs internal tasks.
- The `--script_dir` parameter specifies that the SQL script is in the `$ORACLE_HOME/rdbms/admin` directory.
- The `--log_dir` parameter specifies that the output files are placed in the `/disk1/script_output` directory.
- The `--incl_con` parameter specifies that the SQL script is run in the `hrpdb` and `salespdb` PDBs. The script is not run in any other containers in the CDB.
- The `--log_file_base` parameter specifies that the base name for log file names is `catblock_output`.

### Example 13-37 Running the `catblock.sql` Script in All Containers Except for Specific PDBs

The following example runs the `catblock.sql` script in all of the containers in a CDB except for the `hrpdb` and `salespdb` PDBs.

```
$ORACLE_HOME/perl/bin/perl $ORACLE_HOME/rdbms/admin/catcon.pl --usr SYS
--script_dir $ORACLE_HOME/rdbms/admin --log_dir '/disk1/script_output' --
excl_con 'HRPDB SALESPDB'
--log_file_base catblock_output catblock.sql
```

The following parameters are specified:

- The `--usr` parameter specifies that `SYS` user runs the script in each container.
- The `--script_dir` parameter specifies that the SQL script is in the `$ORACLE_HOME/rdbms/admin` directory.
- The `--log_dir` parameter specifies that the output files are placed in the `/disk1/script_output` directory.

- The `--excl_con` parameter specifies that the SQL script is run in all of the containers in the CDB except for the `hrpdb` and `salespdb` PDBs.
- The `--log_file_base` parameter specifies that the base name for log file names is `catblock_output`.

### Example 13-38 Running a SQL Script with Command Line Parameters

The following example runs the `custom_script.sql` script in all of the containers of a CDB.

```
cd $ORACLE_HOME/perl/bin/  
perl $ORACLE_HOME/rdbms/admin/catcon.pl --usr SYS --script_dir /u01/  
scripts --log_file_base custom_script_output custom_script.sql '--phr' '--  
PEnter password for user hr:'
```

The following parameters are specified:

- The `--usr` parameter specifies that `SYS` user runs the script in each container.
- The `--script_dir` parameter specifies that the SQL script is in the `/u01/scripts` directory.
- The `--log_file_base` parameter specifies that the base name for log file names is `custom_script_output`.
- The `--p` parameter specifies `hr` for a command line parameter
- The `--P` parameter specifies an interactive parameter that prompts for the password of user `hr`.

Default parameter values are used for all other parameters. Neither the `-incl_con` nor the `-excl_con` parameter is specified. Therefore, `catcon.pl` runs the script in all containers by default.

### Example 13-39 Running a SQL Statement in All Containers in a CDB

The following example runs a SQL statement in all of the containers of a CDB.

```
cd $ORACLE_HOME/perl/bin/  
perl $ORACLE_HOME/rdbms/admin/catcon.pl --usr SYS --echo --log_file_base  
select_output -- --x"SELECT * FROM DUAL"
```

The following parameters are specified:

- The `--usr` parameter specifies that `SYS` user runs the script in each container.
- The `--echo` parameter shows output for the SQL statement.
- The `--log_file_base` parameter specifies that the base name for log file names is `select_output`.
- The SQL statement `SELECT * FROM DUAL` is inside quotation marks and is preceded by `--x`. Because `--x` is preceded by a parameter (`--log_file_base`), it must be preceded by `--`.

Default parameter values are used for all other parameters. Neither the `-incl_con` nor the `-excl_con` parameter is specified. Therefore, `catcon.pl` runs the SQL statement in all containers by default.

 **See Also:**

- ["Modifying the Open Mode of One or More PDBs"](#)
- *Oracle Database Administrator's Guide* for information about the `catblock.sql` script
- *Oracle Database SQL Language Reference* for more information about SQL scripts

## 13.5.4 Executing Code in Containers Using the DBMS\_SQL Package

When you are executing PL/SQL code in a container in a CDB, and you want to execute one or more SQL statements in a different container, use the `DBMS_SQL` package to switch containers.

For example, you can use the `DBMS_SQL` package to switch containers when you need to perform identical actions in more than one container.

The following are considerations for using `DBMS_SQL` to switch containers:

- A transaction cannot span multiple containers.  
If the set of actions you must perform in the target container requires a transaction, then consider using an autonomous transaction and perform a commit or rollback as the last action.
- `SET ROLE` statements are not allowed.

### Example 13-40 Performing Identical Actions in More Than One Container

This example includes a PL/SQL block that creates the `identact` table in the `hr` schema in two PDBs (`pdb1` and `pdb2`). The example also inserts a row into the `identact` table in both PDBs.

```
DECLARE
  c1 INTEGER;
  rowcount INTEGER;
  taskList VARCHAR2(32767) :=
    'DECLARE
     PRAGMA AUTONOMOUS TRANSACTION;
    BEGIN
     -- Create the hr.identact table.
     EXECUTE IMMEDIATE
      'CREATE TABLE hr.identact
       (actionno NUMBER(4) NOT NULL,
        action VARCHAR2 (10))';
     EXECUTE IMMEDIATE
      'INSERT INTO identact VALUES(1, 'ACTION1')';
     -- A commit is required if the tasks include DML.
     COMMIT;
     EXCEPTION
     WHEN OTHERS THEN
      -- If there are errors, then drop the table.
     BEGIN
```

```

        EXECUTE IMMEDIATE 'DROP TABLE identact';
    EXCEPTION
    WHEN OTHERS THEN
        NULL;
    END;
END;';
TYPE containerListType IS TABLE OF VARCHAR2(128) INDEX BY PLS_INTEGER;
containerList containerListType;
BEGIN
    containerList(1) := 'PDB1';
    containerList(2) := 'PDB2';
    c1 := DBMS_SQL.OPEN_CURSOR;
    FOR conIndex IN containerList.first..containerList.last LOOP
        DBMS_OUTPUT.PUT_LINE('Creating in container: ' ||
            containerList(conIndex));
        DBMS_SQL.PARSE(c => c1 ,
            statement => taskList,
            language_flag => DBMS_SQL.NATIVE,
            edition => NULL,
            apply_crossedition_trigger => NULL,
            fire_apply_trigger => NULL,
            schema => 'HR',
            container => containerList(conIndex));
        rowcount := DBMS_SQL.EXECUTE(c=>c1);
    END LOOP;
    DBMS_SQL.CLOSE_CURSOR(c=>c1);
END;
/

```

#### See Also:

- *Oracle Database PL/SQL Packages and Types Reference* for more information about the `DBMS_SQL` package
- *Oracle Database PL/SQL Language Reference* for more information about autonomous transactions

## 13.6 Shutting Down a CDB Instance

You can shut down a CDB instance in the same way that you shut down a non-CDB instance.

### Prerequisites

The following prerequisites must be met:

- The CDB instance must be mounted or open.
- The current user must be a common user with `SYSDBA`, `SYSOPER`, `SYSBACKUP`, or `SYSDG` administrative privilege. To shut down a CDB, you must exercise this

privilege using AS SYSDBA, AS SYSOPER, AS SYSBACKUP, or AS SYSDG, respectively, at connect time.

**To shut down a CDB:**

1. In SQL\*Plus, ensure that the current container is the root.  
See "[Connecting to a Container Using the SQL\\*Plus CONNECT Command](#)".
2. Shut down the CDB instance.

 **See Also:**

- "[Modifying the Open Mode of One or More PDBs](#)"
- "[About the Current Container](#)"
- *Oracle Database Administrator's Guide* to learn how to shut down an instance

# 14

## Administering a CDB Fleet

A **CDB fleet** is a collection of CDBs and hosted PDBs that you can manage as one logical CDB.

This chapter contains the following topics:

- [About CDB Fleets](#)  
A **lead CDB** is the central location for monitoring and managing the CDBs in the fleet.
- [Purpose of a CDB Fleet](#)  
A CDB fleet provides the database infrastructure for scalability and centralized management of many CDBs.
- [Setting the Lead CDB in a CDB Fleet](#)  
Set the lead CDB in a CDB fleet by setting the `LEAD_CDB` database property to `true`.
- [Designating a CDB Fleet Member](#)  
Designate a fleet member by setting the `LEAD_CDB_URI` database property to a database link that points to the lead CDB.

### 14.1 About CDB Fleets

A **lead CDB** is the central location for monitoring and managing the CDBs in the fleet.

Designate one CDB in the fleet to be the lead CDB by setting its `LEAD_CDB` database property to `TRUE`. The other CDBs in the fleet point to the lead CDB by setting the `LEAD_CDB_URI` database property. After you configure the CDB fleet, PDB information from the various CDBs is synchronized with the lead CDB. All PDBs in the CDBs are now “visible” in the lead CDB, enabling you to access the PDBs in the fleet as a single, logical CDB from the lead CDB.

The following figure shows a CDB fleet consisting of CDB1, CDB2, and CDB3. The lead CDB is CDB1. CDB2\_hrpdb, which resides in CDB2, is visible in CDB1. CDB3\_hrpdb, which resides in CDB3, is also visible in CDB1.

**Figure 14-1 CDB Fleet**

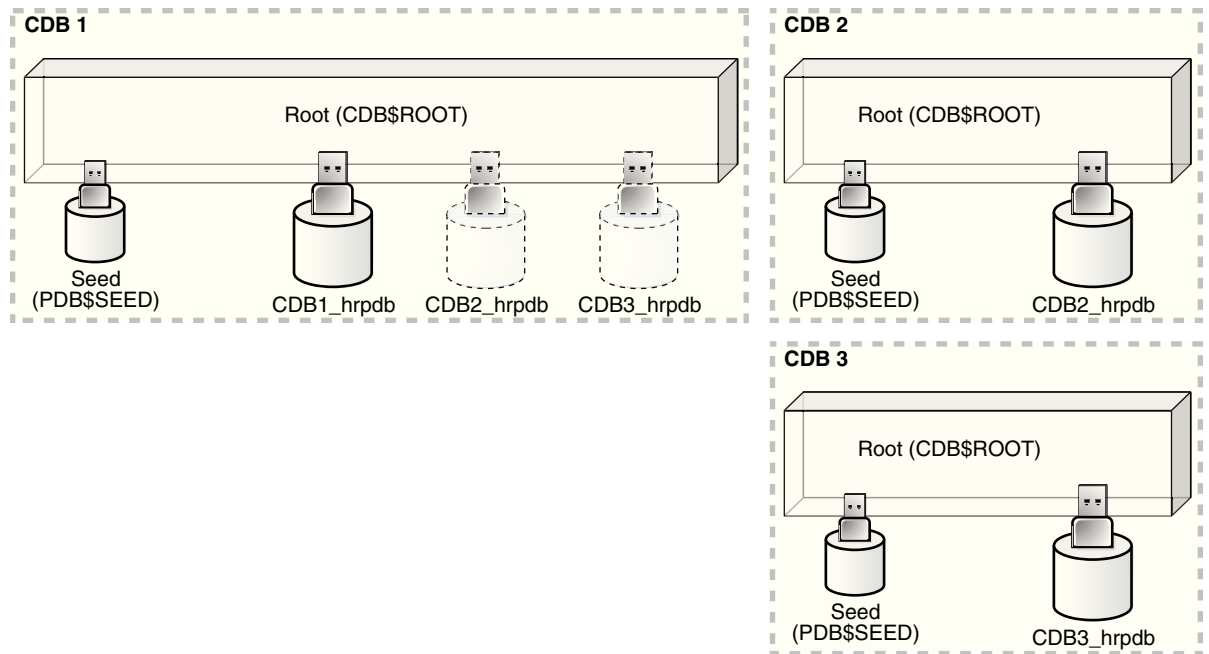

All Oracle Database features, such as Oracle Real Application Cluster (Oracle RAC), RMAN, point-in-time recovery, and flashback features, are supported for CDBs in the fleet.

You can use the following cross-container features to access the CDBs and PDBs in a CDB fleet:

- CDB views
- GV\$ views
- The `CONTAINERS` clause
- Container maps

If a common application schema is configured with application containers, then these cross-container features enable query and data aggregation across PDBs in different CDBs managed in the fleet.

 **Note:**

- Each PDB name must be unique across all CDBs in a CDB fleet.
- You can create a PDB in any CDB in the fleet, but you can only open a PDB in the CDB where it was created.



 **See Also:**

- ["Monitoring CDBs and PDBs"](#)
- ["Partitioning by PDB with Container Maps"](#)

## 14.2 Purpose of a CDB Fleet

A CDB fleet provides the database infrastructure for scalability and centralized management of many CDBs.

A CDB fleet is useful in the following situations:

- The number of PDBs you must provision exceeds the `MAX_PDBS` initialization parameter setting, requiring you to create multiple CDBs.
- Different PDBs in a single configuration require different types of servers to function optimally.

For example, some PDBs might process a large transaction load, while other PDBs are used mainly for monitoring, and you want the appropriate server resources for these PDBs, such as CPU, memory, I/O rate, and storage systems.

- Different PDBs that use the same application must reside in different locations.

### Monitoring and Diagnostic Collection Across CDBs

The lead CDB can run monitoring and reporting applications that execute across the CDBs in the fleet. You can install a monitoring application in one container, and then use CDB views and `GV$` views to monitor and process diagnostic data for the entire CDB fleet. A cross-container query issued in the lead CDB can automatically execute in all PDBs across the CDB fleet.

### Software as a Service (SaaS) Applications

Using a common schema and common application objects in different application containers across the CDB fleet, you can use the `CONTAINERS` clause or a container map to run queries across all PDBs in the CDB fleet. To ensure a common application schema across the CDBs, the application can be installed in an application root.

A typical use case involves installing the master application root in the lead CDB. An application root clone resides in every other CDB in the fleet. Proxy PDBs for the application root clones reside in the master application root.

### Database as a Service (DBaaS) Applications

The lead CDB can serve as a central location where you can collect and view usage metrics and status of all or a subset of the PDBs provisioned in the CDB fleet.

### Microservices

Microservices are a specialization of service-oriented architectures used to build flexible, independently deployable software systems. With microservices, each team can deploy and manage a CDB fleet with customized scaling and availability SLAs. The CDBs can use different storage systems and configuration settings and cater to

different types of workloads. The lead CDB can help the central DBA manage the collection of CDBs associated with each individual microservice.

 **See Also:**

- ["Monitoring CDBs and PDBs"](#)
- ["Partitioning by PDB with Container Maps"](#)
- *Oracle Database Reference* to learn more about `MAX_PDBS`

## 14.3 Setting the Lead CDB in a CDB Fleet

Set the lead CDB in a CDB fleet by setting the `LEAD_CDB` database property to `true`.

**To set the lead CDB in a CDB fleet:**

1. In SQL\*Plus, ensure that the current container is the root of the CDB that will be the lead CDB.
2. Optionally, check the current `LEAD_CDB` database property by running the following query:

```
SELECT PROPERTY_VALUE
FROM   DATABASE_PROPERTIES
WHERE  PROPERTY_NAME=' LEAD_CDB' ;
```

3. Set the `LEAD_CDB` database property to `TRUE`.

**Example 14-1 Setting the Lead CDB Database Property to true**

1. Access the CDB root:

```
ALTER SESSION SET CONTAINER = CDB$ROOT;
```

2. Run the following SQL statement:

```
ALTER DATABASE SET LEAD_CDB = TRUE;
```

 **See Also:**

["About Container Access in a CDB"](#)

## 14.4 Designating a CDB Fleet Member

Designate a fleet member by setting the `LEAD_CDB_URI` database property to a database link that points to the lead CDB.

## Prerequisites

You must use a database link with fixed user semantics, which means that the user name and password are in the link definition. The link cannot use connected user semantics, in which case the user name and password are not in the link definition.

### To designate a CDB fleet member:

1. In SQL\*Plus, ensure that the current container is the root of the CDB that you want to designate as a fleet member.
2. Optionally, check the current `LEAD_CDB_URI` database property by running the following query:

```
SELECT PROPERTY_VALUE FROM DATABASE_PROPERTIES WHERE  
PROPERTY_NAME='LEAD_CDB_URI';
```

3. If a database link does not exist, then create a link to the root of the lead CDB in the fleet.

The database link must be a fixed common user database link.

4. Set the `LEAD_CDB_URI` database property to the name of the database link to the lead CDB.

### Example 14-2 Designating a CDB Fleet Member

This example assumes that the lead CDB is `cdb1` and that the database link to the lead CDB does not exist. It also assumes that the network is configured so that the current CDB can connect to `cdb1` using the `lead_pod` service name.

1. Access the root of the CDB that you want to designate as a fleet member:

```
ALTER SESSION SET CONTAINER = CDB$ROOT;
```

2. Create the database link to `cdb1`:

```
CREATE PUBLIC DATABASE LINK lead_link  
CONNECT TO C##CF1 IDENTIFIED BY password  
USING 'lead_pod';
```

3. Set the `LEAD_CDB_URI` property to the name of the database link:

```
ALTER DATABASE SET LEAD_CDB_URI = 'dblink:LEAD_LINK';
```

#### See Also:

- ["About Container Access in a CDB"](#)
- *Oracle Database Administrator's Guide* for information about fixed user database links

# 15

## Administering PDBs

Administering PDBs includes tasks such as connecting to a PDB, modifying a PDB, and managing services associated with PDBs.

### Note:

You can complete the tasks in this chapter using SQL\*Plus or Oracle SQL Developer. To learn how to administer PDBs using Oracle Enterprise Manager Cloud Control (Cloud Control), see "[Administering PDBs with Cloud Control](#)".

This chapter contains the following topics:

- [About PDB Administration](#)  
Administering a pluggable database (PDB) involves a subset of the tasks required to administer a non-CDB.
- [Managing Connections to a PDB](#)  
You manage connections for a PDB in the same way as for a non-CDB, with some special considerations.
- [Modifying a PDB at the System Level](#)  
You can use the `ALTER SYSTEM` statement to modify a PDB.
- [Modifying a PDB at the Database Level](#)  
You can modify a PDB using the `ALTER PLUGGABLE DATABASE` statement.
- [Starting Up and Shutting Down a PDB](#)  
When the current container is a PDB, you can use the SQL\*Plus `STARTUP` command to open the PDB and the SQL\*Plus `SHUTDOWN` command to close the PDB.

### Related Topics

- [Tools for a Multitenant Environment](#)  
You can use various tools to configure and administer a multitenant environment.

## 15.1 About PDB Administration

Administering a pluggable database (PDB) involves a subset of the tasks required to administer a non-CDB.

In this subset of tasks, most are the same for a PDB and a non-CDB, but differences exist. For example, there are differences when you modify the open mode of a PDB. Also, a PDB administrator is limited to managing a single PDB and cannot manage other PDBs in the multitenant container database (CDB).

This section contains the following topics:

- [Tasks Common to PDBs and Non-CDBs](#)  
Most administrative tasks are the same for a PDB and a non-CDB.
- [Tasks Specific to CDBs](#)  
Some administrative tasks cannot be performed when the current container is a PDB.



**See Also:**

"[Modifying a PDB at the Database Level](#)" for more information about changing the open mode of the current PDB

## 15.1.1 Tasks Common to PDBs and Non-CDBs

Most administrative tasks are the same for a PDB and a non-CDB.

When you are administering a PDB, you can modify the PDB with an `ALTER DATABASE`, `ALTER PLUGGABLE DATABASE`, or `ALTER SYSTEM` statement. You can also execute DDL statements on the PDB. The following table describes some of these tasks common to a PDB and non-CDB.

**Table 15-1 Administrative Tasks Common to PDBs and Non-CDBs**

Task	Description	Additional Information
Managing tablespaces	You can create, modify, and drop tablespaces for a PDB. You can specify a default tablespace and default tablespace type for each PDB. Also, there is a default temporary tablespace for each PDB. You optionally can create additional temporary tablespaces for use by individual PDBs.	" <a href="#">Modifying a PDB at the Database Level</a> " <i>Oracle Database Administrator's Guide</i> for information about managing tablespaces
Managing data files and temp files	Each PDB has its own data files. You can manage data files and temp files in the same way that you would manage them for a non-CDB. You can also limit the amount of storage used by the data files for a PDB by using the <code>STORAGE</code> clause in a <code>CREATE PLUGGABLE DATABASE</code> or <code>ALTER PLUGGABLE DATABASE</code> statement.	" <a href="#">Modifying a PDB at the Database Level</a> " <i>Oracle Database Administrator's Guide</i> for information about managing data files and temp files

**Table 15-1 (Cont.) Administrative Tasks Common to PDBs and Non-CDBs**

Task	Description	Additional Information
Managing schema objects	<p>You can create, modify, and drop schema objects in a PDB in the same way that you would in a non-CDB. You can also create triggers that fire for a specific PDB.</p> <p>When you manage database links in a CDB, the root has a unique global database name, and so does each PDB. The global name of the root is defined by the <code>DB_NAME</code> and <code>DB_DOMAIN</code> initialization parameters. The global database name of a PDB is defined by the PDB name and the <code>DB_DOMAIN</code> initialization parameter. The global database name of each PDB must be unique within the domain.</p>	<p><i>Oracle Database Administrator's Guide</i> for more information about schema objects</p> <p><i>Oracle Database Administrator's Guide</i></p> <p><i>Oracle Database PL/SQL Language Reference</i> for information about creating triggers in a CDB</p>

## 15.1.2 Tasks Specific to CDBs

Some administrative tasks cannot be performed when the current container is a PDB.

The following tasks are performed by a common user for the entire CDB or for the CDB root when the current container is the root:

- Starting up and shutting down a CDB instance
- Modifying the CDB or the root with an `ALTER DATABASE` statement
- Modifying the CDB or the root with an `ALTER SYSTEM` statement
- Executing data definition language (DDL) statements on a CDB or the root
- Managing the following components:
  - Processes
  - Memory
  - Errors and alerts
  - Diagnostic data
  - Control files
  - The online redo log and the archived redo log files
  - Undo
- Creating, plugging in, unplugging, and dropping PDBs

A common user whose current container is the root can also change the open mode of one or more PDBs. Similarly, a common user or local user whose current container is a PDB can change the open mode of the current PDB.

 **See Also:**

- ["About the Current Container"](#)
- ["Administering a CDB"](#) for more information about this task and other tasks related to administering a CDB or the root

## 15.2 Managing Connections to a PDB

You manage connections for a PDB in the same way as for a non-CDB, with some special considerations.

This section contains the following topics:

- [Connecting to a PDB](#)  
You can use several techniques to connect to a PDB with the SQL\*Plus `CONNECT` command.
- [Managing Services for PDBs](#)  
You can create, modify, or remove services for a PDB.
- [Modifying the Listener Settings of a Referenced PDB](#)  
A PDB that is referenced by a proxy PDB is called a referenced PDB.

### 15.2.1 Connecting to a PDB

You can use several techniques to connect to a PDB with the SQL\*Plus `CONNECT` command.

This section assumes that you understand how to connect to a non-CDB in SQL\*Plus.

You can use the following techniques to connect to a PDB with the SQL\*Plus `CONNECT` command:

- Local connection with operating system authentication
- Database connection using easy connect
- Database connection using a net service name

#### Prerequisites

The following prerequisites must be met:

- The user connecting to the PDB must be granted the `CREATE SESSION` privilege in the PDB.
- To connect to a PDB as a user that does not have `SYSDBA`, `SYSOPER`, `SYSBACKUP`, or `SYSDBG` administrative privilege, the PDB must be open.

 **Note:**

This section assumes that the user connecting to the PDB using a local user account. You can also connect to the PDB as a common user, and you can connect to the root as a common user and switch to the PDB.

**To connect to a PDB using the SQL\*Plus CONNECT command:**

1. Configure your environment so that you can open SQL\*Plus.
2. Start SQL\*Plus with the `/NOLOG` argument:

```
sqlplus /nolog
```

3. Issue a `CONNECT` command using easy connect or a net service name to connect to the PDB.

To connect to a PDB, connect to a service with a `PDB` property.

**Example 15-1 Connecting to a PDB in SQL\*Plus Using the PDB's Net Service Name**

The following command connects to the `hr` user using the `hrapp` service. The `hrapp` service has a `PDB` property for the `hrpdb` PDB. This example assumes that the client is configured to have a net service name for the `hrapp` service.

```
CONNECT hr@hrapp
```

 **See Also:**

- ["Modifying the Open Mode of One or More PDBs"](#) and ["Modifying a PDB at the Database Level"](#) for information about changing the open mode of a PDB.
- ["About Container Access in a CDB"](#) for information about connecting to a PDB as a common user
- ["Managing Services for PDBs"](#)
- *Oracle Database Administrator's Guide* for information about connecting to the database with SQL\*Plus

## 15.2.2 Managing Services for PDBs

You can create, modify, or remove services for a PDB.

This section contains the following topics:

- [About Services for PDBs](#)  
Each PDB has a default service, but you can create your own using `SRVCTL` or `DBMS_SERVICE`.



- [Managing Services for a PDB Using SRVCTL and DBMS\\_SERVICE](#)  
You can create, modify, or remove a service with a PDB property.



**See Also:**

*Oracle Database Administrator's Guide*

## 15.2.2.1 About Services for PDBs

Each PDB has a default service, but you can create your own using SRVCTL or DBMS\_SERVICE.

This section contains the following topics:

- [The PDB Property](#)  
The PDB property associates a service with a PDB. When a client connects to a service with a PDB property, the current container for the connection is the PDB.
- [Default and User-Defined Services](#)  
Creating a PDB creates a new default service for the PDB automatically.
- [Tools for Managing Services](#)  
Oracle recommends using the SRVCTL utility to create and modify services. Alternatively, you can use the DBMS\_SERVICE package.

### 15.2.2.1.1 The PDB Property

The PDB property associates a service with a PDB. When a client connects to a service with a PDB property, the current container for the connection is the PDB.

The PDB property is required only when you do either of the following:

- Create a service
- Modify the PDB property of a service

You do not specify a PDB property when you start, stop, or remove a service. Also, you do not need to specify a PDB property when you modify a service without modifying its PDB property.

You can view the PDB property for a service by querying the ALL\_SERVICES data dictionary view. Alternatively, when using the SRVCTL utility, you can use the `srvctl config service` command.



**See Also:**

["About the Current Container"](#)

### 15.2.2.1.2 Default and User-Defined Services

Creating a PDB creates a new default service for the PDB automatically.

Each database service name must be unique in a CDB, and each database service name must be unique within the scope of all the CDBs whose instances are reached through a specific listener. The default service has the same name as the PDB. You cannot manage this service, which you should only use for administrative tasks.

Always use user-defined services for applications. The reason is that you can customize user-defined services to fit the requirements of your applications. Oracle recommends that you not use the default PDB service for applications.

 **Note:**

Do not associate a service with a proxy PDB.

In an Oracle Clusterware environment, you must create an Oracle Clusterware resource for each service that is created for the PDB. When your database is being managed by Oracle Restart or Oracle Clusterware, and when you use the SRVCTL utility to start a service with a PDB property for a PDB that is closed, the PDB is opened in read/write mode on the nodes where the service is started. However, stopping a PDB service does not change the open mode of the PDB.

When you unplug or drop a PDB, the services of the unplugged or dropped PDB are not removed automatically. You can remove these services manually.

 **See Also:**

- ["Modifying a PDB with the ALTER PLUGGABLE DATABASE Statement"](#) for information about changing the open mode of a PDB
- ["Creating a Proxy PDB That References an Application Root Replica"](#)

### 15.2.2.1.3 Tools for Managing Services

Oracle recommends using the SRVCTL utility to create and modify services. Alternatively, you can use the `DBMS_SERVICE` package.

#### SRVCTL

If your single-instance database is being managed by Oracle Restart or your Oracle RAC database is being managed by Oracle Clusterware, then use the Server Control (SRVCTL) utility to create, modify, or remove the service.

To create a service for a PDB using the SRVCTL utility, use the `add service` command and specify the PDB in the `-pdb` parameter. If you do not specify `-pdb`, then the service is associated with the root.

To modify the `PDB` property of a service using the SRVCTL utility, use the `modify service` command and specify the PDB in the `-pdb` parameter. To remove a service for a PDB using the SRVCTL utility, use the `remove service` command.

You can use other SRVCTL commands to manage the service, such as the `start service`, `stop service`, and `relocate service` commands, even if they do not include the `-pdb` parameter.

The PDB name is not validated when you create or modify a service with the SRVCTL utility. However, an attempt to start a service with invalid PDB name results in an error.

### DBMS\_SERVICE

If your database is not being managed by Oracle Restart or Oracle Clusterware, then use the `DBMS_SERVICE` package to create or remove a database service.

`DBMS_SESSION` exists at the root level and in each PDB. It is owned and executed by `SYS` at each level. A PDB administrator cannot stop, relocate, or test the connection for a service that is owned by another PDB.

When you create a service with the `DBMS_SERVICE` package, the `PDB` property of the service is set to the current container. Therefore, to create a service with a `PDB` property set to a specific PDB using the `DBMS_SERVICE` package, run the `CREATE_SERVICE` procedure when the PDB is the current container. If you create a service using the `CREATE_SERVICE` procedure when the current container is the root, then the service is associated with the root.

You cannot modify the `PDB` property of a service with the `DBMS_SERVICE` package. However, you can remove a service in one PDB and create a similar service in a different PDB. In this case, the new service has the `PDB` property of the PDB in which it was created.

You can also use other `DBMS_SERVICE` subprograms to manage the service, such as the `START_SERVICE` and `STOP_SERVICE` procedures. You can use `DBMS_SERVICE.*_CONNECTION_TEST` procedures to check the health of a database connection during planned maintenance. Use the `DELETE_SERVICE` procedure to remove a service.

#### See Also:

- ["Example 19-9"](#)
- *Oracle Database Administrator's Guide* for information about configuring automatic restart of an Oracle database
- *Oracle Database PL/SQL Packages and Types Reference* for information about the `DBMS_SERVICE` package
- *Oracle Real Application Clusters Administration and Deployment Guide* for information about creating services in an Oracle Real Application Clusters (Oracle RAC) environment

## 15.2.2.2 Managing Services for a PDB Using SRVCTL and DBMS\_SERVICE

You can create, modify, or remove a service with a PDB property.

### To manage a service with a PDB property using the SRVCTL utility:

1. Log in to the host computer with the correct user account.
2. Ensure that you run SRVCTL from the correct Oracle home.
3. Perform one of the following operations:
  - To create or modify a service, run the `add service` command, and specify the PDB in the `-pdb` parameter.
  - To modify the PDB property of a service, run the `modify service` command, and specify the PDB in the `-pdb` parameter.
  - To remove a service, run the `remove service` command.

### To create or remove a service for a PDB using the DBMS\_SERVICE package:

1. In SQL\*Plus, ensure that the current container is a PDB.  
See "[Connecting to a PDB](#)".
2. Run the appropriate subprogram in the DBMS\_SERVICE package.

 **Note:**

If your database is being managed by Oracle Restart or Oracle Clusterware, then use the SRVCTL utility to manage services. Do not use the DBMS\_SERVICE package.

### Example 15-2 Creating a Service for a PDB Using the SRVCTL Utility

This example adds the `salesrep` service for the PDB `salespdb` in the CDB with `DB_UNIQUE_NAME mycdb`:

```
srvctl add service -db mycdb -service salesrep -pdb salespdb
```

### Example 15-3 Modifying the PDB Property of a Service Using the SRVCTL Utility

This example modifies the `salesrep` service in the CDB with `DB_UNIQUE_NAME mycdb` to associate the service with the `hrpdb` PDB:

```
srvctl modify service  
-db mycdb  
-service salesrep  
-pdb hrpdb
```

**Example 15-4 Relocating a Service in Oracle RAC Using the SRVCTL Utility**

You can use the `relocate service` command to relocate a service from one Oracle RAC instance, where the service is currently running, to another instance, where it can run. This technique applies both to services for administrator-managed databases as well as singleton services for policy-managed databases.

The following command relocates service `svcl` from Oracle RAC instance `cdb_inst1`, where it is currently running, to instance `cdb_inst2`, where it is currently not running:

```
srvctl relocate service
  db cdb
  service svcl
  oldinst cdb_inst1
  newinst cdb_inst2
  -drain_timeout NNN
  -stopoption immediate
```

The following command performs the same operation for a policy-managed database:

```
srvctl relocate service
  db cdb
  service svcl
  currentnode cdb_inst1
  targetnode cdb_inst2
  -drain_timeout NNN
  -stopoption immediate
```

**Example 15-5 Removing a Service Using the SRVCTL Utility**

This example removes the `salesrep` service in the CDB with `DB_UNIQUE_NAME mycdb`:

```
srvctl remove service
  -db mycdb
  -service salesrep
```

**Example 15-6 Creating a Service for a PDB Using the DBMS\_SERVICE Package**

This example creates the `salesrep` service for the current PDB:

```
BEGIN
  DBMS_SERVICE.CREATE_SERVICE(
    service_name => 'salesrep',
    network_name => 'salesrep.example.com');
END;
/
```

The `PDB` property of the service is set to the current container. For example, if the current container is the `salespdb` PDB, then the `PDB` property of the service is `salespdb`.

**Example 15-7 Removing a Service Using the DBMS\_SERVICE Package**

This example removes the `salesrep` service in the current PDB.

```
BEGIN
  DBMS_SERVICE.DELETE_SERVICE(
    service_name => 'salesrep');
END;
/
```

 **See Also:**

- ["Example 19-9"](#)
- *Oracle Database PL/SQL Packages and Types Reference* for information about the `DBMS_SERVICE` package
- *Oracle Real Application Clusters Administration and Deployment Guide* for information about managing services in an Oracle Real Application Clusters (Oracle RAC) environment

## 15.2.3 Modifying the Listener Settings of a Referenced PDB

A PDB that is referenced by a proxy PDB is called a referenced PDB.

When the port or host name changes for the listener of the referenced PDB, you must modify the listener settings of the referenced PDB so that its proxy PDBs continue to function properly.

This section contains the following topics:

- [Altering the Listener Host Name of a Referenced PDB](#)  
When the host name of the listener for a referenced PDB changes, you must run an `ALTER PLUGGABLE DATABASE CONTAINERS HOST` statement to reset the host name of the referenced PDB so that its proxy PDBs continue to function properly.
- [Altering the Listener Port Number of a Referenced PDB](#)  
When the port number of the listener for a referenced PDB changes, you must run an `ALTER PLUGGABLE DATABASE CONTAINERS PORT` statement to reset the port number of the referenced PDB so that its proxy PDBs continue to function properly.

**Related Topics**

- [Creating a PDB as a Proxy PDB](#)  
You can create a PDB as a proxy PDB by referencing it in a remote CDB.

### 15.2.3.1 Altering the Listener Host Name of a Referenced PDB

When the host name of the listener for a referenced PDB changes, you must run an `ALTER PLUGGABLE DATABASE CONTAINERS HOST` statement to reset the host name of the referenced PDB so that its proxy PDBs continue to function properly.

A proxy PDB uses a database link to establish communication with its referenced PDB during PDB creation. After communication is established, the proxy PDB communicates directly with the referenced PDB without using a database link, and the database link can be dropped. When the listener host name changes for the referenced PDB, each proxy PDB must reestablish communication with its referenced PDB.

The listener host name of a referenced PDB is a database property. When it is set, you can view the current setting by querying the `DATABASE_PROPERTIES` data dictionary view.

The current user must have the `ALTER DATABASE` system privilege, and the privilege must be either commonly granted or locally granted in the PDB.

1. In SQL\*Plus, ensure that the current container is the referenced PDB.  
See "[Connecting to a PDB](#)".
2. Run an `ALTER PLUGGABLE DATABASE CONTAINERS HOST` statement and specify the new host name, or include the `RESET` keyword to return the host name to its default setting, which is the host name of the referenced PDB.
3. Drop and re-create the proxy PDBs that reference the referenced PDB to reestablish communication for each proxy PDB and its referenced PDB.

#### Example 15-8 Altering the Listener Host Name of a Referenced PDB

This example changes the host name for the referenced PDB to `myhost.example.com`.

```
ALTER PLUGGABLE DATABASE CONTAINERS HOST='myhost.example.com';
```

#### Example 15-9 Resetting the Listener Host Name to the Default Value

This example resets the host name for the referenced PDB to its default value. The default value is the host name of the referenced PDB.

```
ALTER PLUGGABLE DATABASE CONTAINERS HOST RESET;
```



#### See Also:

- "[Creating a PDB as a Proxy PDB](#)"
- "[HOST Clause](#)"

### 15.2.3.2 Altering the Listener Port Number of a Referenced PDB

When the port number of the listener for a referenced PDB changes, you must run an `ALTER PLUGGABLE DATABASE CONTAINERS PORT` statement to reset the port number of the referenced PDB so that its proxy PDBs continue to function properly.

A proxy PDB uses a database link to establish communication with its referenced PDB during PDB creation. After communication is established, the proxy PDB communicates directly with the referenced PDB without using a database link, and the database link can be dropped. When the listener port number changes for the referenced PDB, each proxy PDB must re-establish communication with its referenced PDB.

The listener port number of a referenced PDB is a database property. When it is set, you can view the current setting by querying the `DATABASE_PROPERTIES` data dictionary view.

The current user must have the `ALTER DATABASE` system privilege, and the privilege must be either commonly granted or locally granted in the PDB.

1. In SQL\*Plus, ensure that the current container is the referenced PDB.
2. Run an `ALTER PLUGGABLE DATABASE CONTAINERS PORT` statement and specify the new port number, or include the `RESET` keyword to return the port number to its default setting, which is 1521.
3. Drop and re-create the proxy PDBs that reference the referenced PDB to re-establish communication for each proxy PDB and its referenced PDB.

#### Example 15-10 Altering the Listener Port Number of a Referenced PDB

This example changes the port number for the referenced PDB to 1543.

```
ALTER PLUGGABLE DATABASE CONTAINERS PORT=1543;
```

#### Example 15-11 Resetting the Listener Port Number to the Default Value

This example resets the port number for the referenced PDB to its default value. The default value for the port number is 1521.

```
ALTER PLUGGABLE DATABASE CONTAINERS PORT RESET;
```

#### Related Topics

- [Connecting to a PDB](#)  
You can use several techniques to connect to a PDB with the SQL\*Plus `CONNECT` command.
- [Creating a PDB as a Proxy PDB](#)  
You can create a PDB as a proxy PDB by referencing it in a remote CDB.
- [PORT Clause](#)  
The `PORT` clause of the `CREATE PLUGGABLE DATABASE` statement specifies the port number of the listener for the PDB being created.



## 15.3 Modifying a PDB at the System Level

You can use the `ALTER SYSTEM` statement to modify a PDB.

This section contains the following topics:

- [About System-Level Modifications of a PDB](#)  
The `ALTER SYSTEM` statement can dynamically alter a PDB. You can issue an `ALTER SYSTEM` statement when you want to change the way a PDB operates.
- [Modifying a PDB with ALTER SYSTEM](#)  
To modify a PDB at the system level, use the `ALTER SYSTEM` statement (just as for a non-CDB).

### 15.3.1 About System-Level Modifications of a PDB

The `ALTER SYSTEM` statement can dynamically alter a PDB. You can issue an `ALTER SYSTEM` statement when you want to change the way a PDB operates.

When the current container is a PDB, you can run the following `ALTER SYSTEM` statements:

- `ALTER SYSTEM FLUSH { SHARED_POOL | BUFFER_CACHE | FLASH_CACHE }`
- `ALTER SYSTEM { ENABLE | DISABLE } RESTRICTED SESSION`
- `ALTER SYSTEM SET USE_STORED_OUTLINES`
- `ALTER SYSTEM { SUSPEND | RESUME }`
- `ALTER SYSTEM CHECKPOINT`
- `ALTER SYSTEM CHECK DATAFILES`
- `ALTER SYSTEM REGISTER`
- `ALTER SYSTEM { KILL | DISCONNECT } SESSION`
- `ALTER SYSTEM SET initialization_parameter` (for a subset of initialization parameters)

All other `ALTER SYSTEM` statements affect the entire CDB and must be run by a common user in the root.

The `ALTER SYSTEM SET initialization_parameter` statement can modify only some initialization parameters for PDBs. All initialization parameters can be set for the root. For any initialization parameter that is not set explicitly for a PDB, the PDB inherits the parameter value from the root.

You can modify an initialization parameter for a PDB when the `ISPDB_MODIFIABLE` column is `TRUE` for the parameter in the `V$SYSTEM_PARAMETER` view. The following query lists all initialization parameters that are modifiable for a PDB:

```
SELECT NAME
FROM   V$SYSTEM_PARAMETER
WHERE  ISPDB_MODIFIABLE='TRUE'
ORDER BY NAME;
```

When the current container is a PDB, run the `ALTER SYSTEM SET initialization_parameter` statement to modify the PDB. The statement does not affect the root or other PDBs. The following table describes the behavior of the `SCOPE` clause when you use a server parameter file (SPFILE) and run the `ALTER SYSTEM SET` statement on a PDB.

SCOPE Setting	Behavior
MEMORY	<p>The initialization parameter setting is changed in memory and takes effect immediately in the PDB. The new setting affects only the PDB.</p> <p>The setting reverts to the value set in the root in any of the following cases:</p> <ul style="list-style-type: none"> <li>An <code>ALTER SYSTEM SET</code> statement sets the value of the parameter in the root with <code>SCOPE</code> equal to <code>BOTH</code> or <code>MEMORY</code>, and the PDB is closed and re-opened. The parameter value in the PDB is not changed if <code>SCOPE</code> is equal to <code>SPFILE</code>, and the PDB is closed and re-opened.</li> <li>The PDB is closed and re-opened.</li> <li>The CDB is shut down and re-opened.</li> </ul>
SPFILE	<p>The initialization parameter setting is changed for the PDB and stored persistently. The new setting takes effect in any of the following cases:</p> <ul style="list-style-type: none"> <li>The PDB is closed and re-opened.</li> <li>The CDB is shut down and re-opened.</li> </ul> <p>In these cases, the new setting affects only the PDB.</p>
BOTH	<p>The initialization parameter setting is changed in memory, and it is changed for the PDB and stored persistently. The new setting takes effect immediately in the PDB and persists after the PDB is closed and re-opened or the CDB is shut down and re-opened. The new setting affects only the PDB.</p>

When a PDB is unplugged from a CDB, the values of the initialization parameters that were specified for the PDB with `SCOPE=BOTH` or `SCOPE=SPFILE` are added to the PDB's XML metadata file. These values are restored for the PDB when it is plugged in to a CDB.

 **Note:**

A text initialization parameter file (PFILE) cannot contain PDB-specific parameter values.

 **See Also:**

- ["Unplugging a PDB from a CDB"](#)
- ["About the Current Container"](#)
- ["Modifying a CDB with ALTER SYSTEM"](#)
- Oracle Database SQL Language Reference*

## 15.3.2 Modifying a PDB with ALTER SYSTEM

To modify a PDB at the system level, use the `ALTER SYSTEM` statement (just as for a non-CDB).

### Prerequisites

The current user must be granted the following privileges, which must be either commonly granted or locally granted in the PDB:

- `CREATE SESSION`
- `ALTER SYSTEM`

### To use `ALTER SYSTEM` to modify a PDB:

1. In SQL\*Plus, ensure that the current container is a PDB.  
See "[Connecting to a PDB](#)".
2. Run the `ALTER SYSTEM` statement.

### Example 15-12 Enable Restricted Sessions in a PDB

To restrict sessions in a PDB, issue the following statement:

```
ALTER SYSTEM ENABLE RESTRICTED SESSION;
```

### Example 15-13 Changing the Statistics Gathering Level for the PDB

This `ALTER SYSTEM` statement sets the `STATISTICS_LEVEL` initialization parameter to `ALL` for the current PDB:

```
ALTER SYSTEM SET STATISTICS_LEVEL = ALL SCOPE = MEMORY;
```



#### See Also:

- "[Modifying a CDB with ALTER SYSTEM](#)"
- *Oracle Database SQL Language Reference*

## 15.4 Modifying a PDB at the Database Level

You can modify a PDB using the `ALTER PLUGGABLE DATABASE` statement.

This section contains the following topics:

- [About Database-Level Modifications of a PDB](#)  
The `ALTER PLUGGABLE DATABASE` for a PDB is analogous to the `ALTER DATABASE` for a non-CDB.

- [Modifying a PDB with the ALTER PLUGGABLE DATABASE Statement](#)  
To modify the attributes of a single PDB, use the `ALTER PLUGGABLE DATABASE` statement.
- [Changing the Global Database Name of a PDB](#)  
You can change the global database name of a PDB with the `ALTER PLUGGABLE DATABASE RENAME GLOBAL_NAME TO statement`.
- [Managing Refreshable Clone PDBs](#)  
A **refreshable clone PDB** is a read-only clone that can periodically synchronize with its source PDB.

## 15.4.1 About Database-Level Modifications of a PDB

The `ALTER PLUGGABLE DATABASE` for a PDB is analogous to the `ALTER DATABASE` for a non-CDB.

### Note:

An `ALTER DATABASE` statement issued when the current container is a PDB that includes clauses that are supported for an `ALTER PLUGGABLE DATABASE` statement have the same effect as the corresponding `ALTER PLUGGABLE DATABASE` statement. However, these statements cannot include clauses that are specific to PDBs, such as the *pdb\_storage\_clause*, the *pdb\_change\_state\_clause*, the *logging\_clause*, and the *pdb\_recovery\_clause*.

This section contains the following topics:

- [Storage Clauses](#)  
Use `ALTER PLUGGABLE DATABASE` to configure storage at the PDB level.
- [Logging and Recovery Clauses](#)  
Use `ALTER PLUGGABLE DATABASE` to set logging and recovery and recovery modes at the PDB level.
- [Miscellaneous Clauses](#)  
You can use `ALTER PLUGGABLE DATABASE` to modify the open mode, global name, time zone, and default edition.

### 15.4.1.1 Storage Clauses

Use `ALTER PLUGGABLE DATABASE` to configure storage at the PDB level.

The following clauses of `ALTER PLUGGABLE DATABASE` modify PDB storage:

- *database\_file\_clauses*  
These clauses work the same as they would in an `ALTER DATABASE` statement, but the statement applies to the current PDB.
- `DEFAULT TABLESPACE` clause  
For users created while the current container is a PDB, this clause specifies the default tablespace for the user if the default tablespace is not specified in the `CREATE USER` statement.

- **DEFAULT TEMPORARY TABLESPACE clause**  
For users created while the current container is a PDB, this clause specifies the default temporary tablespace for the user if the default temporary tablespace is not specified in the `CREATE USER` statement.
- **SET DEFAULT { BIGFILE | SMALLFILE } TABLESPACE clause**  
This clause changes the default type of subsequently created tablespaces in the PDB to either bigfile or smallfile. This clause works the same as it would in an `ALTER DATABASE` statement, but it applies to the current PDB.
- ***pdb\_storage\_clause***  
This clause sets a limit on the amount of storage used by all tablespaces that belong to a PDB. This limit applies to the total size of all data files and temp files comprising tablespaces that belong to the PDB.  
  
This clause can also set a limit on the amount of storage that can be used by unified audit OS spillover (.bin format) files in the PDB. If the limit is reached, then no additional storage is available for these files.  
  
This clause can also set a limit on the amount of storage in a shared temporary tablespace that can be used by sessions connected to the PDB. If the limit is reached, then no additional storage in the shared temporary tablespace is available to sessions connected to the PDB.

### 15.4.1.2 Logging and Recovery Clauses

Use `ALTER PLUGGABLE DATABASE` to set logging and recovery and recovery modes at the PDB level.

#### **logging\_clause**



#### **Note:**

This clause is available starting with Oracle Database 12c Release 1 (12.1.0.2).

This clause specifies the logging attribute of the PDB. The logging attribute controls whether certain DML operations are logged in the redo log file (`LOGGING`) or not (`NOLOGGING`).

You can use this clause to specify one of the following attributes:

- `LOGGING` indicates that any future tablespaces created within the PDB will be created with the `LOGGING` attribute by default. You can override this default logging attribute by specifying `NOLOGGING` at the schema object level, in a `CREATE TABLE` statement for example.
- `NOLOGGING` indicates that any future tablespaces created within the PDB will be created with the `NOLOGGING` attribute by default. You can override this default logging attribute by specifying `LOGGING` at the schema object level, in a `CREATE TABLE` statement for example.

The specified attribute is used to establish the logging attribute of tablespaces created within the PDB if the *logging\_clause* is not specified in the `CREATE TABLESPACE` statement.

The `DBA_PDBS` view shows the current logging attribute for a PDB.

 **Note:**

The PDB must be open in restricted mode to use this clause.

### `pdb_force_logging_clause`

 **Note:**

This clause is available starting with Oracle Database 12c Release 1 (12.1.0.2).

This clause places a PDB into force logging or force nologging mode or takes a PDB out of force logging or force nologging mode.

You can use this clause to specify one of the following attributes:

- `ENABLE FORCE LOGGING` places the PDB in force logging mode, which causes all changes in the PDB, except changes in temporary tablespaces and temporary segments, to be logged. Force logging mode cannot be overridden at the schema object level.

PDB-level force logging mode takes precedence over and is independent of any `NOLOGGING` or `FORCE LOGGING` settings you specify for individual tablespaces in the PDB and any `NOLOGGING` settings you specify for individual database objects in the PDB.

`ENABLE FORCE LOGGING` cannot be specified if a PDB is in force nologging mode. `DISABLE FORCE NOLOGGING` must be specified first.

- `DISABLE FORCE LOGGING` takes a PDB which is currently in force logging mode out of that mode. If the PDB is not in force logging mode currently, then specifying `DISABLE FORCE LOGGING` results in an error.
- `ENABLE FORCE NOLOGGING` places the PDB in force nologging mode, which causes no changes in the PDB to be logged. Force nologging mode cannot be overridden at the schema object level.

CDB-wide force logging mode supersedes PDB-level force nologging mode. PDB-level force nologging mode takes precedence over and is independent of any `LOGGING` or `FORCE LOGGING` settings you specify for individual tablespaces in the PDB and any `LOGGING` settings you specify for individual database objects in the PDB.

`ENABLE FORCE NOLOGGING` cannot be specified if a PDB is in force logging mode. `DISABLE FORCE LOGGING` must be specified first.

- `DISABLE FORCE NOLOGGING` takes a PDB that is currently in force nologging mode out of that mode. If the PDB is not in force nologging mode currently, then specifying `DISABLE FORCE NOLOGGING` results in an error.

The `DBA_PDBS` view shows whether a PDB is in force logging or force nologging mode.

 **Note:**

The PDB must be open in restricted mode to use this clause.

### `pdb_recovery_clause`

 **Note:**

This clause is available starting with Oracle Database 12c Release 1 (12.1.0.2).

`ALTER PLUGGABLE DATABASE DISABLE RECOVERY` takes the data files that belong to the PDB offline and disables recovery of the PDB. The PDB data files are not part of any recovery session until it is enabled again. Any new data files created while recovery is disabled are created as unnamed files for the PDB.

`ALTER PLUGGABLE DATABASE ENABLE RECOVERY` brings the data files that belong to the PDB online and marks the PDB for active recovery. Recovery sessions include these files.

Check the recovery status of a PDB by querying the `RECOVERY_STATUS` column in the `V$PDBS` view.

 **See Also:**

- *Oracle Data Guard Concepts and Administration* for more information about the `pdb_recovery_clause`.
- *Oracle Database Administrator's Guide* for information about controlling the writing of redo records
- *Oracle Database SQL Language Reference* for more information about the logging attribute

## 15.4.1.3 Miscellaneous Clauses

You can use `ALTER PLUGGABLE DATABASE` to modify the open mode, global name, time zone, and default edition.

When the current container is a PDB, an `ALTER PLUGGABLE DATABASE` statement with any of the following clauses modifies the PDB:

- *pdb\_change\_state\_clause*

This clause changes the open mode of the current PDB.

If you specify the optional `RESTRICTED` keyword, then the PDB is accessible only to users with the `RESTRICTED SESSION` privilege in the PDB.

Specifying `FORCE` in this clause changes semantics of the `ALTER PLUGGABLE DATABASE` statement so that, in addition to opening a PDB that is currently closed, it can be used to change the open mode of a PDB that is already open.
- `RENAME GLOBAL_NAME` clause

This clause changes the unique global database name for the PDB. The new global database name must be different from that of any container in the CDB. When you change the global database name of a PDB, the PDB name is changed to the name before the first period in the global database name.

You must change the `PDB` property of database services used to connect to the PDB when you change the global database name.
- *set\_time\_zone\_clause*

This clause works the same as it would in an `ALTER DATABASE` statement, but it applies to the current PDB.
- `DEFAULT EDITION` clause

This clause works the same as it would in an `ALTER DATABASE` statement, but it applies to the current PDB. Each PDB can use edition-based redefinition, and editions in one PDB do not affect editions in other PDBs. In a multitenant environment in which each PDB has its own application, you can use edition-based redefinition independently for each distinct application.

 **See Also:**

- ["Managing Services for PDBs"](#)
- ["Modifying the Open Mode of PDBs with ALTER PLUGGABLE DATABASE"](#)

## 15.4.2 Modifying a PDB with the ALTER PLUGGABLE DATABASE Statement

To modify the attributes of a single PDB, use the `ALTER PLUGGABLE DATABASE` statement.

When the current container is a PDB, an `ALTER PLUGGABLE DATABASE` statement modifies the PDB. The modifications overwrite the defaults set for the root in the PDB. The modifications do not affect the CDB root or other PDBs.

### Prerequisites

The following prerequisites must be met:



- To change the open mode of the PDB from mounted to opened or from opened to mounted, the current user must have `SYSDBA`, `SYSOPER`, `SYSBACKUP`, or `SYSDG` administrative privilege. The privilege must be either commonly granted or locally granted in the PDB. The user must exercise the privilege using `AS sys_privilege_name` at connect time.
- For all other operations performed using the `ALTER PLUGGABLE DATABASE` statement, the current user must have the `ALTER DATABASE` system privilege, and the privilege must be either commonly granted or locally granted in the PDB.
- To close a PDB, the PDB must be open.



**Note:**

This section does not cover changing the global database name of a PDB using the `ALTER PLUGGABLE DATABASE` statement.

**To modify a PDB:**

1. In SQL\*Plus, ensure that the current container is a PDB.
2. Run an `ALTER PLUGGABLE DATABASE` statement.

**Example 15-14 Changing the Open Mode of a PDB**

This `ALTER PLUGGABLE DATABASE` statement changes the open mode of the current PDB to mounted.

```
ALTER PLUGGABLE DATABASE CLOSE IMMEDIATE;
```

The following statement changes the open mode of the current PDB to open read-only.

```
ALTER PLUGGABLE DATABASE OPEN READ ONLY;
```

A PDB must be in mounted mode to change its open mode to read-only or read/write unless you specify the `FORCE` keyword.

The following statement changes the open mode of the current PDB from mounted or open read-only to open read/write.

```
ALTER PLUGGABLE DATABASE OPEN FORCE;
```

The following statement changes the open mode of the current PDB from mounted to migrate.

```
ALTER PLUGGABLE DATABASE OPEN UPGRADE;
```

**Example 15-15 Bringing a Data File Online for a PDB**

This ALTER PLUGGABLE DATABASE statement uses a *database\_file\_clause* to bring the /u03/oracle/pdb1\_01.dbf data file online.

```
ALTER PLUGGABLE DATABASE DATAFILE '/u03/oracle/pdb1_01.dbf' ONLINE;
```

**Example 15-16 Changing the Default Tablespaces for a PDB**

This ALTER PLUGGABLE DATABASE statement uses a DEFAULT TABLESPACE clause to set the default permanent tablespace to pdb1\_tbs for the PDB.

```
ALTER PLUGGABLE DATABASE DEFAULT TABLESPACE pdb1_tbs;
```

This ALTER PLUGGABLE DATABASE statement uses a DEFAULT TEMPORARY TABLESPACE clause to set the default temporary tablespace to pdb1\_temp for the PDB.

```
ALTER PLUGGABLE DATABASE DEFAULT TEMPORARY TABLESPACE pdb1_temp;
```

The tablespace or tablespace group specified in the ALTER PLUGGABLE DATABASE statement must exist in the PDB. Users whose current container is a PDB that are not explicitly assigned a default tablespace or default temporary tablespace use the default tablespace or default temporary tablespace for the PDB.

**Example 15-17 Changing the Default Tablespace Type for a PDB**

This ALTER DATABASE statement uses a SET DEFAULT TABLESPACE clause to change the default tablespace type to bigfile for the PDB.

```
ALTER PLUGGABLE DATABASE SET DEFAULT BIGFILE TABLESPACE;
```

**Example 15-18 Setting Storage Limits for a PDB**

This statement sets the storage limit for all tablespaces that belong to a PDB to two gigabytes.

```
ALTER PLUGGABLE DATABASE STORAGE(MAXSIZE 2G);
```

This statement specifies that there is no storage limit for the tablespaces that belong to the PDB.

```
ALTER PLUGGABLE DATABASE STORAGE(MAXSIZE UNLIMITED);
```

This statement specifies that there is no storage limit for the tablespaces that belong to the PDB and that there is no storage limit for the shared temporary tablespace that can be used by sessions connected to the PDB.

```
ALTER PLUGGABLE DATABASE STORAGE UNLIMITED;
```

### Example 15-19 Setting the Logging Attribute of a PDB

With the PDB open in restricted mode, this statement specifies the `NOLOGGING` attribute for the PDB:

```
ALTER PLUGGABLE DATABASE NOLOGGING;
```

### Example 15-20 Setting the Force Logging Mode of a PDB

This statement enables force logging mode for the PDB:

```
ALTER PLUGGABLE DATABASE ENABLE FORCE LOGGING;
```

### Example 15-21 Setting the Default Edition for a PDB

This example sets the default edition for the current PDB to `PDB1E3`.

```
ALTER PLUGGABLE DATABASE DEFAULT EDITION = PDB1E3;
```



#### See Also:

- ["About Database-Level Modifications of a PDB"](#) for information about the clauses that modify the attributes of a single PDB
- ["Changing the Global Database Name of a PDB"](#)
- *Oracle Database SQL Language Reference* for more information about the `ALTER PLUGGABLE DATABASE` statement
- *Oracle Database Development Guide* for a complete discussion of edition-based redefinition

## 15.4.3 Changing the Global Database Name of a PDB

You can change the global database name of a PDB with the `ALTER PLUGGABLE DATABASE RENAME GLOBAL_NAME TO statement`.

When you change the global database name of a PDB, the new global database name must be different from that of any container in the CDB.

### Prerequisites

The following prerequisites must be met:

- The current user must have the `ALTER DATABASE` system privilege, and the privilege must be either commonly granted or locally granted in the PDB.
- For an Oracle Real Application Clusters (Oracle RAC) database, the PDB must be open on the current instance only. The PDB must be closed on all other instances.
- The PDB being modified must be opened on the current instance in read/write mode with `RESTRICTED` specified so that it is accessible only to users with `RESTRICTED SESSION` privilege in the PDB.

**To change the global database name of a PDB:**

1. In SQL\*Plus, ensure that the current container is a PDB.
2. Run an `ALTER PLUGGABLE DATABASE RENAME GLOBAL_NAME TO` statement.

The following example changes the global database name of the PDB to `salespdb.example.com`:

```
ALTER PLUGGABLE DATABASE RENAME GLOBAL_NAME TO salespdb.example.com;
```

3. Close the PDB.
4. Open the PDB in read/write mode.

When you change the global database name of a PDB, the PDB name is changed to the first part of the new global name, which is the part before the first period. Also, Oracle Database changes the name of the default database service for the PDB automatically. Oracle Database also changes the `PDB` property of all database services in the PDB to the new global name of the PDB. You must close the PDB and open it in read/write mode for Oracle Database to complete the integration of the new PDB service name into the CDB.

Oracle Net Services must be configured properly for clients to access database services. You might need to alter your Oracle Net Services configuration because of the PDB name change.

 **See Also:**

- ["Connecting to a PDB"](#)
- ["Managing Services for PDBs"](#) for information about PDBs and database services

## 15.4.4 Managing Refreshable Clone PDBs

A **refreshable clone PDB** is a read-only clone that can periodically synchronize with its source PDB.

This section contains the following topics:

- [Refreshing a PDB](#)  
You can refresh a PDB that was created as a refreshable clone.
- [Switching Over a Refreshable Clone PDB](#)  
You can switch the roles of a source PDB and its refreshable clone PDB.

### 15.4.4.1 Refreshing a PDB

You can refresh a PDB that was created as a refreshable clone.

When you refresh a PDB manually, changes made to the source PDB since the last refresh are propagated to the PDB being refreshed. You can manually refresh a PDB that is configured for automatic refresh.

### Prerequisites

To refresh a PDB, the PDB must have been created as a clone with the `REFRESH MODE MANUAL` or `REFRESH MODE EVERY minutes` clause included.

1. In SQL\*Plus, ensure that the current container is the PDB you want to refresh.
2. If the PDB is not closed, then close the PDB. For example, issue the following SQL statement:

```
ALTER PLUGGABLE DATABASE CLOSE IMMEDIATE;
```

3. Issue the following SQL statement:

```
ALTER PLUGGABLE DATABASE REFRESH;
```

### Related Topics

- [About Refreshable Clone PDBs](#)  
The `CREATE PLUGGABLE DATABASE ... REFRESH MODE` statement clones a source PDB and configures the clone to be refreshable. Refreshing the clone PDB updates it with redo accumulated since the last redo log apply.

## 15.4.4.2 Switching Over a Refreshable Clone PDB

You can switch the roles of a source PDB and its refreshable clone PDB.

The following statement performs a switchover:

```
ALTER PLUGGABLE DATABASE refresh_mode FROM clonepdb@dblink SWITCHOVER;
```

You must not specify `REFRESH MODE NONE` for *refresh\_mode*. The database link specified in the `FROM` clause must point to the root of the CDB in which the clone PDB resides.

After the switchover completes, the source PDB becomes the refreshable clone PDB, which can only be opened in `READ ONLY` mode.

### Prerequisites

You must meet the following prerequisites:

- You must be connected to the source PDB when you issue `ALTER PLUGGABLE DATABASE ... SWITCHOVER`.
- If the source PDB and clone PDB are in separate CDBs, then the user specified in the database link must have the same name and password in the source PDB and clone PDB.

### To switch the roles of the source and clone PDBs:

1. In SQL\*Plus or SQL Developer, log in to the source PDB.
2. Execute the `ALTER PLUGGABLE DATABASE refresh_mode FROM clonepdb@dblink SWITCHOVER` statement.

After the statement completes, the currently connected PDB is now the refreshable clone PDB.

3. Optionally, refresh the clone PDB:

```
ALTER PLUGGABLE DATABASE REFRESH;
```

### Example 15-22 Switching Over a Refreshable Clone PDB

This example assumes that your data center contains CDBs named `cdb1` and `cdb2`. The PDB named `cdb1_pdb1` resides in `cdb1`. You want to create a refreshable clone of this PDB in `cdb2` and name it `cdb1_pdb1_ref`. Your goal is to switch over `cdb1_pdb1_ref` so that it becomes the source PDB and `cdb1_pdb1` becomes the clone PDB.

1. In SQL\*Plus, connect to `cdb1` as a user with administrator privileges, and then ensure sure that `cdb1_pdb1` is open in read/write mode (sample output included):

```
CONNECT SYS@cdb1 AS SYSDBA
Enter password: *****
```

```
ALTER PLUGGABLE DATABASE ALL CLOSE;
ALTER PLUGGABLE DATABASE cdb1_pdb1 OPEN READ WRITE;
SHOW PDBS;
```

CON_ID	CON_NAME	OPEN MODE	RESTRICTED
2	PDB\$SEED	READ ONLY	NO
3	CDB1_PDB1	READ WRITE	NO

2. Create a common user named `c##u1` (replace `pwd` with a user-specified password):

```
DROP USER c##u1 CASCADE;
CREATE USER c##u1 IDENTIFIED BY pwd;
GRANT CREATE SESSION, RESOURCE, CREATE ANY TABLE, UNLIMITED TABLESPACE
TO c##u1 CONTAINER=ALL;
GRANT CREATE PLUGGABLE DATABASE TO c##u1 CONTAINER=ALL;
GRANT SYSOPER TO c##u1 CONTAINER=ALL;
```

3. Set the container to `cdb1_pdb1`, and then create a table `t1` to use for testing (sample output included):

```
ALTER SESSION SET CONTAINER = cdb1_pdb1;
CREATE TABLE t1(n1 NUMBER);
INSERT INTO t1 VALUES(1);
COMMIT;
SELECT * FROM t1;
```

```

      N1
-----
      1
```

4. Connect to `cdb2` as a user with administrator privileges, and then create the common user named `c##u1` (replace `pwd` with a user-specified password):

```
CONNECT SYS@cdb2 AS SYSDBA
Enter password: *****
```

```
DROP USER c##u1 CASCADE;
CREATE USER c##u1 IDENTIFIED BY pwd;
GRANT CREATE SESSION, RESOURCE, CREATE ANY TABLE, UNLIMITED TABLESPACE
TO c##u1 CONTAINER=ALL;
GRANT CREATE PLUGGABLE DATABASE TO c##u1 CONTAINER=ALL;
GRANT SYSOPER TO c##u1 CONTAINER=ALL;
```

Now `cdb1` and `cdb2` both have a common user with the same name (`c##u1`) and password.

5. Create a database link to `cdb1`.

The following command specifies user `c##u1`, password `pwd`, and service name `cdb1`:

```
CREATE DATABASE LINK cdb1_datalink CONNECT TO c##u1 IDENTIFIED BY pwd
USING 'cdb1';
```

6. Create the manually refreshable PDB named `cdb1_pdb1_ref`.

The following statement specifies the database link `cdb1_datalink` and the file destination `/dsk1/df`:

```
CREATE PLUGGABLE DATABASE cdb1_pdb1_ref FROM cdb1_pdb1@cdb1_datalink
  CREATE_FILE_DEST='/dsk1/df'
  REFRESH MODE MANUAL;
```

7. Refresh `cdb1_pdb1_ref`:

```
ALTER SESSION SET CONTAINER = cdb1_pdb1_ref;
ALTER PLUGGABLE DATABASE REFRESH;
```

8. Query `t1` to check that the refreshable clone PDB contains the correct contents (sample output included):

```
ALTER PLUGGABLE DATABASE OPEN READ ONLY;
SELECT * FROM t1;
```

```
          N1
-----
          1
```

9. Connect to `cdb1` as a user with administrator privileges, and then create a database link to `cdb2`:

```
CONNECT SYS@cdb1 AS SYSDBA
Enter password: *****
```

```
CREATE DATABASE LINK cdb2_datalink CONNECT TO c##u1 IDENTIFIED BY pwd
USING 'cdb2';
```

The preceding statement specifies user `c##u1`, password `pwd`, and service name `cdb2`.

10. Set the container to `cdb1_pdb1`, and then switch over so that `cdb1_pdb1_ref` is the primary PDB and the current PDB is the clone:

```
ALTER SESSION SET CONTAINER = cdb1_pdb1;
ALTER PLUGGABLE DATABASE
  REFRESH MODE MANUAL
  FROM cdb1_pdb1_ref@cdb2_data link
  SWITCHOVER;
```

11. Query `t1` to check that the current PDB, which is now the refreshable clone PDB, contains the correct contents (sample output included):

```
ALTER PLUGGABLE DATABASE OPEN READ ONLY;
SELECT * FROM t1;
```

```
      N1
-----
      1
```

12. Connect to `cdb2` as a user with administrator privileges, set the container to the new source PDB `cdb1_pdb1_ref`, and then insert a new row into table `t1` (sample output included):

```
CONNECT SYS@cdb2 AS SYSDBA
Enter password: *****

ALTER SESSION SET CONTAINER = cdb1_pdb1_ref;
SELECT * FROM t1;
```

```
      N1
-----
      1
```

```
INSERT INTO t1 VALUES(2);
COMMIT;
SELECT * FROM t1;
```

```
      N1
-----
      1
      2
```

13. Connect to `cdb1` as a user with administrator privileges, set the container to `cdb1_pdb1` (which is the new clone), refresh it, and then query `t1`:

```
CONNECT SYS@cdb1 AS SYSDBA
Enter password: *****

ALTER SESSION SET CONTAINER = cdb1_pdb1;
ALTER PLUGGABLE DATABASE CLOSE IMMEDIATE;
ALTER PLUGGABLE DATABASE REFRESH;
ALTER PLUGGABLE DATABASE OPEN READ ONLY;
SELECT * FROM t1;
```



```
      N1
-----
      1
      2
```

The preceding output shows that the clone `cdb1_pdb1` was refreshed from the source `cdb1_pdb1_ref`.

## 15.5 Starting Up and Shutting Down a PDB

When the current container is a PDB, you can use the SQL\*Plus `STARTUP` command to open the PDB and the SQL\*Plus `SHUTDOWN` command to close the PDB.

This section contains the following topics:

- [Starting Up a PDB Using the STARTUP Command](#)  
When the current container is a PDB, the SQL\*Plus `STARTUP` command opens the PDB.
- [Shutting Down a PDB Using the SHUTDOWN Command](#)  
When the current container is a PDB, the SQL\*Plus `SHUTDOWN` command closes the PDB.

### 15.5.1 Starting Up a PDB Using the STARTUP Command

When the current container is a PDB, the SQL\*Plus `STARTUP` command opens the PDB.

Use the following options of the `STARTUP` command to open a PDB:

- `FORCE`  
Closes an open PDB before re-opening it in read/write mode. When this option is specified, no other options are allowed.
- `RESTRICT`  
Enables only users with the `RESTRICTED SESSION` system privilege in the PDB to access the PDB.  
  
If neither `OPEN READ WRITE` nor `OPEN READ ONLY` is specified and `RESTRICT` is specified, then the PDB is opened in read-only mode when the CDB to which it belongs is a physical standby database. Otherwise, the PDB is opened in read/write mode.
- `OPEN open_pdb_options`  
Opens the PDB in either read/write mode or read-only mode. Specify `OPEN READ WRITE` or `OPEN READ ONLY`. When `RESTRICT` is not specified, `READ WRITE` is always the default.

To issue the `STARTUP` command when the current container is a PDB, the following prerequisites must be met:

- The current user must have `SYSDBA`, `SYSOPER`, `SYSBACKUP`, or `SYSDG` administrative privilege, and the privilege must be either commonly granted or locally granted in the PDB. The user must exercise the privilege using `AS SYSDBA`, `AS SYSOPER`, `AS SYSBACKUP`, or `AS SYSDG`, respectively, at connect time.

- Excluding the use of the `FORCE` option, the PDB must be in mounted mode to open it.
- To place a PDB in mounted mode, the PDB must be in open read-only or open read/write mode.

**To modify a PDB with the `STARTUP` command:**

1. In SQL\*Plus, ensure that the current container is a PDB.
2. Run the `STARTUP` command.

**Example 15-23 Opening a PDB in Read/Write Mode with the `STARTUP` Command**

```
STARTUP OPEN
```

**Example 15-24 Opening a PDB in Read-Only Mode with the `STARTUP` Command**

```
STARTUP OPEN READ ONLY
```

**Example 15-25 Opening a PDB in Read-Only Restricted Mode with the `STARTUP` Command**

```
STARTUP RESTRICT OPEN READ ONLY
```

**Example 15-26 Opening a PDB in Read/Write Mode with the `STARTUP` Command and the `FORCE` Option**

This example assumes that the PDB is currently open. The `FORCE` option closes the PDB and then opens it in the read/write mode.

```
STARTUP FORCE
```

 **See Also:**

- ["About the Current Container"](#)
- ["Connecting to a PDB"](#).
- *Oracle Database Administrator's Guide* for information about starting up a database
- *SQL\*Plus User's Guide and Reference*

## 15.5.2 Shutting Down a PDB Using the `SHUTDOWN` Command

When the current container is a PDB, the SQL\*Plus `SHUTDOWN` command closes the PDB.

After the `SHUTDOWN` command is issued on a PDB successfully, it is in mounted mode.

The following `SHUTDOWN` modes are possible:

- When you specify `SHUTDOWN` only, then the PDB is shut down with the normal mode.

- When you specify `SHUTDOWN IMMEDIATE`, the PDB is shut down with the immediate mode.
- When you specify `SHUTDOWN ABORT`, the PDB is forcefully closed.

For a single-instance CDB, PDB media recovery is required when you specify `SHUTDOWN ABORT`. For an Oracle Real Application Clusters (Oracle RAC) CDB, PDB media recovery is required if the `SHUTDOWN ABORT` command closes the last open instance.

### Prerequisites

To issue the `SHUTDOWN` command when the current container is a PDB, the following prerequisites must be met:

- The current user must have `SYSDBA`, `SYSOPER`, `SYSBACKUP`, or `SYSDG` administrative privilege, and the privilege must be either commonly granted or locally granted in the PDB. The user must exercise the privilege using `AS SYSDBA`, `AS SYSOPER`, `AS SYSBACKUP`, or `AS SYSDG`, respectively, at connect time.
- To close a PDB, the PDB must be open.

### To modify a PDB with the `SHUTDOWN` command:

1. In SQL\*Plus, ensure that the current container is a PDB.
2. Run the `SHUTDOWN` command.

#### Note:

- When the current container is a PDB, the `SHUTDOWN` command only closes the PDB, not the CDB instance.
- There is no `SHUTDOWN` command for a PDB that is equivalent to `SHUTDOWN TRANSACTIONAL` for a non-CDB.

### Example 15-27 Closing a PDB with the `SHUTDOWN IMMEDIATE` Command

```
SHUTDOWN IMMEDIATE
```

#### See Also:

- ["About the Current Container"](#)
- ["Connecting to a PDB"](#)
- ["Modifying the Open Mode of PDBs with ALTER PLUGGABLE DATABASE"](#)
- *Oracle Database Administrator's Guide* for more information about shutdown modes
- *SQL\*Plus User's Guide and Reference*

# 16

## Administering a PDB Snapshot Carousel

You can configure a PDB snapshot carousel for a specified PDB, create snapshots manually or automatically, and set the maximum number of snapshots.

This section contains the following topics:

- [About PDB Snapshot Carousel](#)  
A **PDB snapshot** is a point-in-time copy of a PDB. You can create snapshots manually using the `SNAPSHOT` clause of `CREATE PLUGGABLE DATABASE` (or `ALTER PLUGGABLE DATABASE`), or automatically using the `EVERY interval` clause. A PDB snapshot carousel is a library of PDB snapshots.
- [Setting the Maximum Number of Snapshots in a PDB Snapshot Carousel](#)  
You can set the maximum number of PDB snapshots for a PDB.
- [Configuring Automatic PDB Snapshots](#)  
Configure a PDB for automatic snapshots by using the `SNAPSHOT MODE EVERY` clause when creating or altering a PDB.
- [Creating PDB Snapshots Manually](#)  
To create a PDB snapshot manually, specify the `SNAPSHOT snapshot_name` clause in `ALTER PLUGGABLE DATABASE` or `CREATE PLUGGABLE DATABASE`.
- [Dropping a PDB Snapshot](#)  
You can drop a PDB snapshot by running an `ALTER PLUGGABLE DATABASE` statement with the `DROP SNAPSHOT` clause.

### 16.1 About PDB Snapshot Carousel

A **PDB snapshot** is a point-in-time copy of a PDB. You can create snapshots manually using the `SNAPSHOT` clause of `CREATE PLUGGABLE DATABASE` (or `ALTER PLUGGABLE DATABASE`), or automatically using the `EVERY interval` clause. A PDB snapshot carousel is a library of PDB snapshots.

This section contains the following topics:

- [Purpose of PDB Snapshot Carousel](#)  
A PDB snapshot carousel is a useful way of maintaining a library of recent PDB copies for point-in-time recovery and cloning.
- [How PDB Snapshot Carousel Works](#)  
The carousel for a specific PDB is a circular library of copies for this PDB.
- [User Interface for PDB Snapshot Carousel](#)  
The `SNAPSHOT MODE` clause controls creation of snapshots, and determines whether creation is manual, automatic, or disabled.

## 16.1.1 Purpose of PDB Snapshot Carousel

A PDB snapshot carousel is a useful way of maintaining a library of recent PDB copies for point-in-time recovery and cloning.

### Cloning PDBs for Development and Testing

In a typical development use case, you clone a production PDB for testing. When the CDB is in `ARCHIVELOG` mode and local undo mode, the source production PDB can be opened in read/write mode and fully functional during the operation. This technique is known as **hot cloning**. The hot clone is transactionally consistent with the source PDB as of the SCN at the completion of the `ALTER PLUGGABLE DATABASE ... OPEN` statement.

For example, while the production PDB named `pdbl_prod` is open and in use, you create a refreshable clone named `pdbl_test_master`. You then configure `pdbl_test_master` to create automatic snapshots every day. When you need new PDBs for testing, create a full clone of any snapshot, and then create sparse clones using `CREATE PLUGGABLE DATABASE ... SNAPSHOT COPY`.

The following figure shows the creation of the clone `pdbl_test_full1` from the PDB snapshot taken on April 5. The figure shows three snapshot copy PDBs created from `pdbl_test_full1`.

Figure 16-1 Automatic Snapshots of a Refreshable Clone PDB

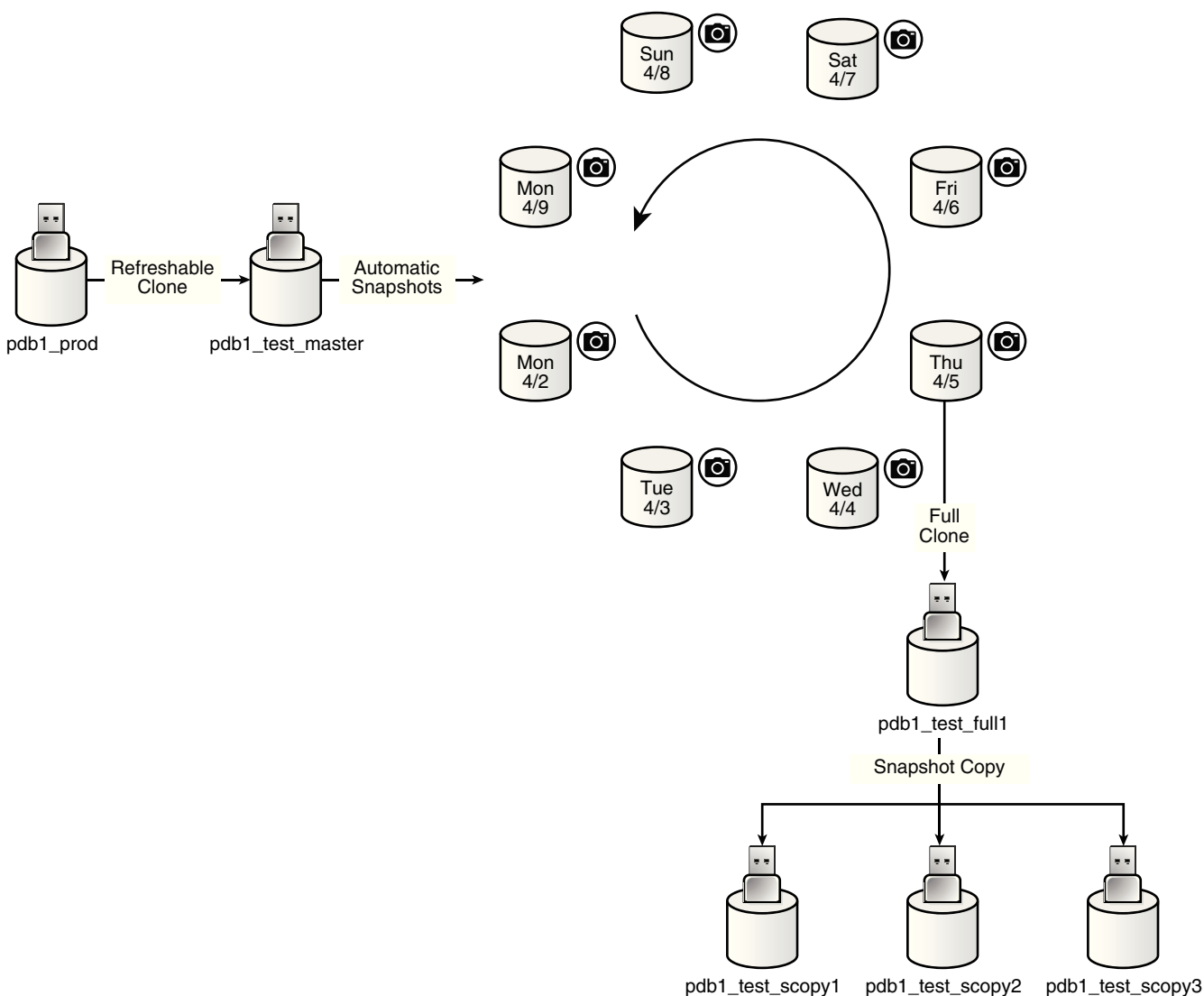

### Point-in-Time Restore with PDB Snapshot Carousel

A typical strategy is to take a snapshot of a PDB every day at the same time. Another strategy is to take a snapshot manually before data loads. In either case, a PDB snapshot carousel enables you to restore a PDB using any available snapshot.

For example, a sales history PDB named `pdb1_prod` generates an automatic snapshot every day at 12:01 a.m. On the daily data load on the afternoon of Monday 4/9, you accidentally load the wrong data, corrupting the PDB. You can create a new production PDB based on the Monday 4/9 snapshot, drop the corrupted PDB, and then retry the data load.

Figure 16-2 Restore a Production PDB Using a Snapshot

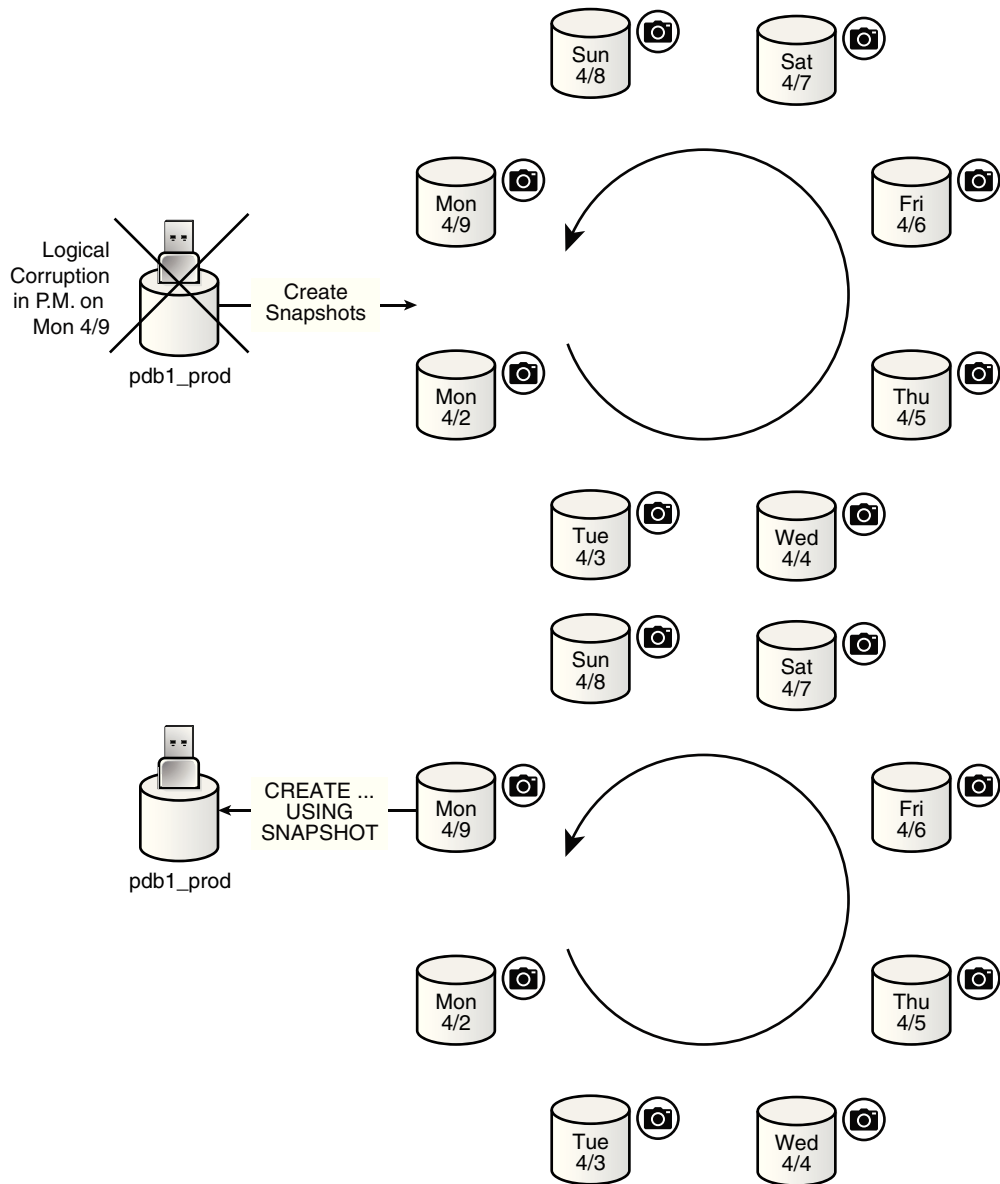

 See Also:

- ["About Cloning a PDB"](#)
- *Oracle Database SQL Language Reference* for `CREATE PLUGGABLE DATABASE` syntax and semantics

## 16.1.2 How PDB Snapshot Carousel Works

The carousel for a specific PDB is a circular library of copies for this PDB.

The database creates successive copies in the carousel either on demand or automatically. The database overwrites the oldest snapshot when the snapshot limit is reached.

This section includes the following topics:

- [Contents of a PDB Snapshot](#)  
The data files of the PDB snapshot reside in an archive file on the file system.
- [Contents of a PDB Snapshot Carousel](#)  
The PDB snapshot carousel is the set of all existing snapshots for a PDB.

### 16.1.2.1 Contents of a PDB Snapshot

The data files of the PDB snapshot reside in an archive file on the file system.

No archived redo log files are included. Typically, the archive is stored in the same directory as the data files for the PDB. For system-generated snapshot names, `snap_` is prefixed to a unique identifier, which contains the snapshot SCN. The archive has the file extension `.pdb`.

The database takes a snapshot using an implicit `USING SNAPSHOT` clause. You cannot specify the `SNAPSHOT COPY` clause when taking a snapshot with `CREATE PLUGGABLE DATABASE SNAPSHOT`.

#### Note:

A PDB snapshot created with the `USING SNAPSHOT` clause and a snapshot copy PDB created with the `SNAPSHOT COPY` clause are two distinct types of snapshots. The `USING SNAPSHOT` clause creates a full PDB that does not need to be materialized. The `SNAPSHOT COPY` clause creates a sparse PDB that must be materialized if you want to drop the storage snapshot on which it is based.

Although a snapshot in a PDB snapshot carousel is always a full PDB, you can take a snapshot copy of a snapshot in the carousel. In this case, the snapshot copy is a sparse clone.

#### See Also:

["How a Snapshot Copy PDB Differs from a Standard Clone"](#)

### 16.1.2.2 Contents of a PDB Snapshot Carousel

The PDB snapshot carousel is the set of all existing snapshots for a PDB.

The `MAX_PDB_SNAPSHOTS` property specifies the maximum number of snapshots permitted in the carousel. The current setting is visible in the `CDB_PROPERTIES` view.

The following figure shows a carousel for `cdb1_pdb1`. In this example, the database takes a PDB snapshot automatically every day, maintaining a set of 8. After the first 8



snapshots have been created, every new snapshot replaces the oldest snapshot. For example, the Tuesday 4/10 snapshot replaces the Monday 4/2 snapshot; the Wednesday 4/11 snapshot replaces the Tuesday 4/3 snapshot; and so on.

**Figure 16-3 PDB Snapshot Carousel**

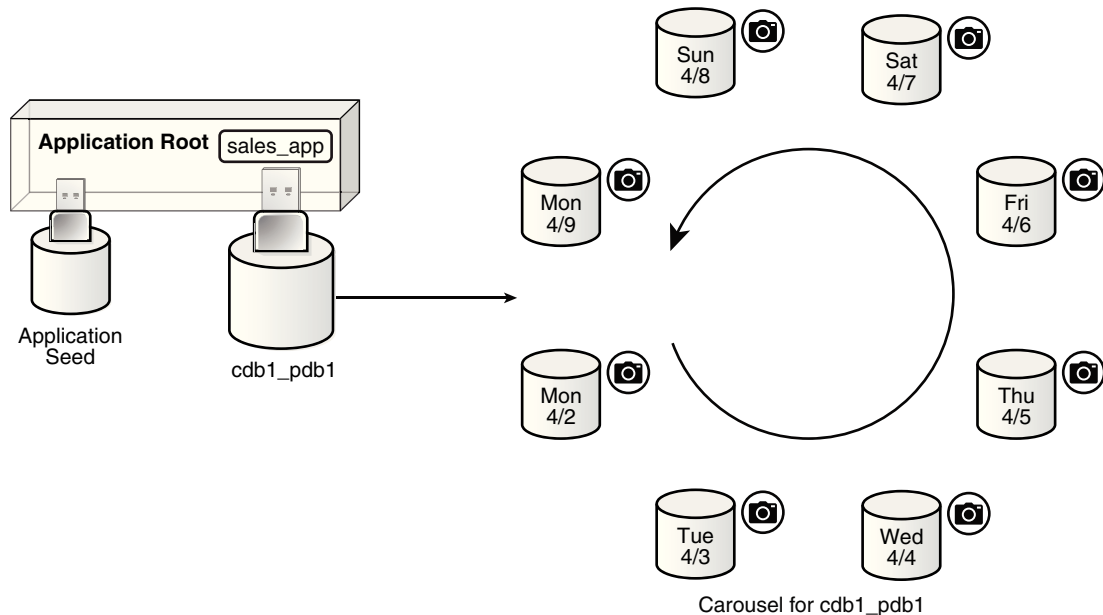

Starting Oracle Database 19c, all PDB snapshots in the carousel except the first one can be sparse, and the source PDB can remain in read/write mode. This feature significantly reduces the storage space consumed by the carousel.

 **See Also:**

*Oracle Database Licensing Information User Manual* for details on which features are supported for different editions and services

### 16.1.3 User Interface for PDB Snapshot Carousel

The `SNAPSHOT MODE` clause controls creation of snapshots, and determines whether creation is manual, automatic, or disabled.

#### CREATE PLUGGABLE DATABASE Statement

To set the snapshot mode for a PDB, use one of the following values in the `SNAPSHOT MODE` clause of `ALTER PLUGGABLE DATABASE` or `CREATE PLUGGABLE DATABASE`:

- `MANUAL`

This clause, which is the default, enables the creation of manual snapshots of the PDB. To create a snapshot on demand, specify the `SNAPSHOT snapshot_name` clause in an `ALTER PLUGGABLE DATABASE` or `CREATE PLUGGABLE DATABASE` statement.

- `EVERY snapshot_interval [MINUTES|HOURS]`

This clause enables the automatic creation of snapshots after an interval of time. The following restrictions apply to the interval specified:

- The minutes value must be less than 3000.
- The hours value must be less than 2000.

The database assigns each automatic snapshot a system-generated name. Note that manual snapshots are also supported for the PDB when `EVERY` is specified.

- `NONE`

This clause disables snapshot creation for the PDB.

#### See Also:

- ["About Cloning PDBs from PDB Snapshots"](#)
- *Oracle Database SQL Language Reference* for the syntax and semantics of the `SNAPSHOT` clause

### MAX\_PDB\_SNAPSHOTS Database Property

To set the maximum number of snapshots for a PDB, specify the `MAX_PDB_SNAPSHOTS` property in `ALTER PLUGGABLE DATABASE` or `CREATE PLUGGABLE DATABASE`. The default for the property is 8, which is also the maximum value. When the maximum allowed number of snapshots has been created, the database purges the oldest snapshot. The `CDB_PROPERTIES` view shows the setting of `MAX_PDB_SNAPSHOTS`.

#### See Also:

*Oracle Database SQL Language Reference* for the syntax of the `ALTER PLUGGABLE DATABASE` statement

### DBA\_PDB\_SNAPSHOTS and DBA\_PDBS

The following data dictionary views provide snapshot information:

- The `DBA_PDB_SNAPSHOTS` view metadata about the snapshots, including name, creation SCN, creation time, and file name.
- The `DBA_PDBS` view has a `SNAPSHOT_MODE` and `SNAPSHOT_INTERVAL` column.

#### See Also:

*Oracle Database Reference* to learn about `DBA_PDB_SNAPSHOTS` and `DBA_PDBS`

## 16.2 Setting the Maximum Number of Snapshots in a PDB Snapshot Carousel

You can set the maximum number of PDB snapshots for a PDB.

The `MAX_PDB_SNAPSHOTS` database property sets the maximum number of snapshots for every PDB in a PDB snapshot carousel. The default maximum is 8. You cannot set the property to a number greater than 8.

### Prerequisites

The PDB must be open in read/write mode.

### To set the maximum number of PDB snapshots for a PDB:

1. In SQL\*Plus, ensure that the current container is the PDB for which you want to set the limit.
2. Optionally, query `CDB_PROPERTIES` for the current setting of the `SET MAX_PDB_SNAPSHOTS` property.
3. Run an `ALTER PLUGGABLE DATABASE` or `ALTER DATABASE` statement with the `SET MAX_PDB_SNAPSHOTS` clause.

### Example 16-1 Setting the Maximum Number of PDB Snapshots for a PDB

The following query shows the maximum in the carousel for `cdb1_pdb1` (sample output included):

```
SET LINESIZE 150
COL CON_ID FORMAT 99999
COL PROPERTY_NAME FORMAT a17
COL PDB_NAME FORMAT a9
COL VALUE FORMAT a3
COL DESCRIPTION FORMAT a43

SELECT r.CON_ID, p.PDB_NAME, PROPERTY_NAME,
       PROPERTY_VALUE AS value, DESCRIPTION
FROM   CDB_PROPERTIES r, CDB_PDBS p
WHERE  r.CON_ID = p.CON_ID
AND    PROPERTY_NAME LIKE 'MAX_PDB%'
ORDER BY PROPERTY_NAME;

CON_ID PDB_NAME  PROPERTY_NAME      VAL DESCRIPTION
-----
3 CDB1_PDB1 MAX_PDB_SNAPSHOTS 8   maximum number of snapshots for a
given PDB
```

The following SQL statement sets the maximum number of PDB snapshots for the current PDB to 7:

```
ALTER PLUGGABLE DATABASE SET MAX_PDB_SNAPSHOTS=7;
```

**Example 16-2 Dropping All Snapshots in a PDB Snapshot Carousel**

To drop all snapshots in a PDB snapshot carousel, set the `MAX_PDB_SNAPSHOTS` database property to 0 (zero), as shown in the following statement:

```
ALTER PLUGGABLE DATABASE SET MAX_PDB_SNAPSHOTS=0;
```

This technique is faster than executing `ALTER PLUGGABLE DATABASE ... DROP SNAPSHOT snapshot_name` for every snapshot.

**See Also:**

["About Container Access in a CDB"](#)

## 16.3 Configuring Automatic PDB Snapshots

Configure a PDB for automatic snapshots by using the `SNAPSHOT MODE EVERY` clause when creating or altering a PDB.

By default, a PDB is configured for manual snapshots.

**Prerequisites**

Note the following prerequisites for the `ALTER PLUGGABLE DATABASE SNAPSHOT` statement:

- The CDB must be in local undo mode.
- The administrator must have the privileges to create a PDB and drop a PDB.

**To configure automatic snapshots when altering a PDB:**

1. In SQL\*Plus, log in as an administrator to the PDB whose snapshot mode you intend to configure.
2. Optionally, query `DBA_PDBS` to determine the current snapshot mode.
3. Run `ALTER PLUGGABLE DATABASE` with the `SNAPSHOT MODE EVERY interval` clause, specifying either `MINUTES` or `HOURS`.

**To configure automatic snapshots when creating a PDB:**

1. In SQL\*Plus, log in as an administrator to the CDB root or application root.
2. Optionally, query `DBA_PDBS` to determine the current snapshot mode.
3. Run `CREATE PLUGGABLE DATABASE` with the `SNAPSHOT MODE EVERY interval` clause, specifying either `MINUTES` or `HOURS`.

**Example 16-3 Configuring an Automatic Snapshot Every Day for an Existing PDB**

This example assumes that you are logged in to the PDB whose snapshot mode you intend to change. Query the data dictionary to confirm that the PDB is currently in `MANUAL` mode (sample output included):

```
SELECT SNAPSHOT_MODE "S_MODE", SNAPSHOT_INTERVAL/60 "SNAP_INT_HRS" FROM
DBA_PDBS;
```

```
S_MODE SNAP_INT_HRS
-----
MANUAL
```

Change the snapshot mode to every 24 hours:

```
ALTER PLUGGABLE DATABASE SNAPSHOT MODE EVERY 24 HOURS;
```

Confirm the change to automatic mode:

```
SELECT SNAPSHOT_MODE "S_MODE", SNAPSHOT_INTERVAL/60 "SNAP_INT_HRS" FROM
DBA_PDBS;
```

```
S_MODE SNAP_INT_HRS
-----
AUTO          24
```

**Example 16-4 Creating a PDB That Takes Snapshots Every Two Hours**

This example assumes that you are logged in to the CDB root. The following statement creates `cdb1_pdb3` from an existing PDB named `cdb1_pdb1`, and configures it to take snapshots automatically every 2 hours:

```
CREATE PLUGGABLE DATABASE cdb1_pdb3 FROM cdb1_pdb1
FILE_NAME_CONVERT=('cdb1_pdb1', 'cdb1_pdb3')
SNAPSHOT MODE EVERY 120 MINUTES;
```

**See Also:**

- ["Cloning a PDB from a PDB Snapshot: Scenario"](#)
- ["Configuring a CDB to Use Local Undo Mode"](#)

## 16.4 Creating PDB Snapshots Manually

To create a PDB snapshot manually, specify the `SNAPSHOT snapshot_name` clause in `ALTER PLUGGABLE DATABASE` or `CREATE PLUGGABLE DATABASE`.

### Prerequisites

Note the following prerequisites for the `ALTER PLUGGABLE DATABASE SNAPSHOT` statement:

- The CDB must be in local undo mode. You can check the mode by using the following query, which returns `TRUE` when local undo is enabled:

```
SELECT * FROM DATABASE_PROPERTIES WHERE
PROPERTY_NAME='LOCAL_UNDO_ENABLED' ;
```

- The database administrator must have the privileges to create a PDB and drop a PDB.

### To create a PDB snapshot:

1. In SQL\*Plus, log in as an administrator to the PDB whose snapshot you intend to create.
2. Optionally, query `DBA_PDBS.SNAPSHOT_MODE` to confirm that the snapshot mode is not set to `NONE`.
3. Run an `ALTER PLUGGABLE DATABASE` statement with the `SNAPSHOT` clause.

### Example 16-5 Creating a Snapshot with a User-Specified Name

The following SQL statements create two PDB snapshots of `cdb1_pdb1`, one before and one after a Wednesday data load:

```
ALTER PLUGGABLE DATABASE SNAPSHOT cdb1_pdb1_b4wedload;
-- data load
ALTER PLUGGABLE DATABASE SNAPSHOT cdb1_pdb1_afwedload;
```

The following query of `DBA_PDB_SNAPSHOTS` shows the locations of two snapshots of the PDB named `cdb1_pdb1` (sample output included):

```
SET LINESIZE 150
COL CON_NAME FORMAT a10
COL SNAPSHOT_NAME FORMAT a20
COL SNAP_SCN FORMAT 9999999
COL FULL_SNAPSHOT_PATH FORMAT a45

SELECT CON_ID, CON_NAME, SNAPSHOT_NAME,
       SNAPSHOT_SCN AS snap_scn, FULL_SNAPSHOT_PATH
FROM   DBA_PDB_SNAPSHOTS
ORDER BY SNAP_SCN;

CON_ID CON_NAME  SNAPSHOT_NAME          SNAP_SCN FULL_SNAPSHOT_PATH
-----
-----
```

```

      3 CDB1_PDB1 CDB1_PDB1_B4WEDLOAD 2962078 /disk1/oracle/dbs/
snap_3489077498_2962078.pdb
      3 CDB1_PDB1 CDB1_PDB1_AFWEDLOAD 2962938 /disk1/oracle/dbs/
snap_3489077498_2962938.pdb

```

If you do not specify a PDB snapshot name, then the database generates a unique name.

### Example 16-6 Creating a Snapshot with a System-Specified Name

The following SQL statement creates a snapshot, but does not specify a name:

```
ALTER PLUGGABLE DATABASE SNAPSHOT;
```

The following sample query shows that the database assigned the snapshot a name prefixed with `SNAP_`:

```

SET LINESIZE 150
COL CON_NAME FORMAT a10
COL SNAPSHOT_NAME FORMAT a25
COL SNAP_SCN FORMAT 9999999
COL FULL_SNAPSHOT_PATH FORMAT a45

SELECT CON_ID, CON_NAME, SNAPSHOT_NAME,
       SNAPSHOT_SCN AS snap_scn, FULL_SNAPSHOT_PATH
FROM   DBA_PDB_SNAPSHOTS
ORDER BY SNAP_SCN;

```

CON_ID	CON_NAME	SNAPSHOT_NAME	SNAP_SCN	FULL_SNAPSHOT_PATH
3	CDB1_PDB1	CDB1_PDB1_B4WEDLOAD	2962078	/disk1/oracle/dbs/ snap_3489077498_2962078.pdb
3	CDB1_PDB1	CDB1_PDB1_AFWEDLOAD	2962938	/disk1/oracle/dbs/ snap_3489077498_2962938.pdb
3	CDB1_PDB1	SNAP_3489077498_960130367	2993525	/disk1/oracle/dbs/ snap_3489077498_2993525.pdb

#### See Also:

- ["About Container Access in a CDB"](#)
- ["Configuring a CDB to Use Local Undo Mode"](#)

## 16.5 Dropping a PDB Snapshot

You can drop a PDB snapshot by running an `ALTER PLUGGABLE DATABASE` statement with the `DROP SNAPSHOT` clause.

To drop all PDB snapshots based on a PDB, set the `MAX_PDB_SNAPSHOTS` property in the PDB to 0 (zero).

### To drop a PDB snapshot:

1. In SQL\*Plus, ensure that the current container is the PDB from which you created the PDB snapshot.
2. Run an `ALTER PLUGGABLE DATABASE` statement with the `DROP SNAPSHOT` clause.

### Example 16-7 Dropping a PDB Snapshot

The following SQL statement drops a PDB snapshot named `sales_snap`:

```
ALTER PLUGGABLE DATABASE DROP SNAPSHOT sales_snap;
```



#### See Also:

["About Container Access in a CDB"](#)



# Administering Application Containers

You can administer application containers, including application roots and application PDBs. You can also administer the applications installed in application containers.

 **Note:**

You can complete the tasks in this chapter using SQL\*Plus or Oracle SQL Developer.

This chapter contains the following topics:

- [About Application Container Administration](#)  
Some aspects of administering an application container are similar to administering the CDB root and the CDB as a whole, while other aspects are similar to administering a PDB.
- [About Modifying an Application Root](#)  
The `ALTER DATABASE` statement can modify an application root. The `ALTER PLUGGABLE DATABASE` statement can modify the open mode of application PDBs.
- [Managing Applications in an Application Container](#)  
You install, upgrade, or patch an application in an application container.
- [Managing Application Common Objects](#)  
Application common objects are shared, user-created database objects in an application container. Application common objects are created in an application root.
- [Issuing DML Statements on Containers in an Application Container](#)  
A DML statement issued in an application root can modify one or more containers in the application container. In addition, you can specify one or more default container targets for DML statements.
- [Partitioning by PDB with Container Maps](#)  
Container maps enable the partitioning of data at the application PDB level when the data is not physically partitioned at the table level.

## Related Topics

- [Creating and Removing Application Containers and Seeds](#)  
You can create application containers and application seeds in several different ways. You can also remove application containers from a CDB, and you can remove application seeds from application containers.
- [Tools for a Multitenant Environment](#)  
You can use various tools to configure and administer a multitenant environment.

## 17.1 About Application Container Administration

Some aspects of administering an application container are similar to administering the CDB root and the CDB as a whole, while other aspects are similar to administering a PDB.

Administering an application container is similar to administering a CDB because you can manage both the application root and the application PDBs that are plugged into the application root. However, administering an application container is also similar to managing a PDB because changes to the application container do not affect other application containers or PDBs in the CDB.

The following table describes administrative tasks for application containers that are similar to administrative tasks that manage a CDB or CDB root.

**Table 17-1 Application Container Administrative Tasks Similar to Those of a CDB**

Administrative Task	Description	More Information
Configuring application common users and commonly granted privileges	Application common users and privileges are similar to common users and commonly granted privileges in a CDB root, but in an application container, common users and commonly granted privileges only exist within the containers of the application container, including the application root, application PDBs that belong to the application root, and an optional application seed that belongs to the application root.	<a href="#">"Overview of Common and Local Users in a CDB"</a>
Creating application containers	A common user whose current container is the CDB root can create application containers that are plugged into the CDB root by specifying the <code>AS APPLICATION CONTAINER</code> clause in the <code>CREATE PLUGGABLE DATABASE</code> statement. The database files must be Oracle Managed Files.	<a href="#">"Creating Application Containers"</a>
Creating application PDBs	A common user whose current container is the application root can create application PDBs that are plugged into the application root.	<a href="#">"Creating and Removing PDBs and Application Containers"</a>

**Table 17-1 (Cont.) Application Container Administrative Tasks Similar to Those of a CDB**

Administrative Task	Description	More Information
Switching to containers	A common user with the proper privileges can switch between containers in an application container, including the application root, application PDBs that belong to the application root, and an optional application seed that belongs to the application root.	<a href="#">"Switching to a Container Using the ALTER SESSION Statement"</a>
Issuing ALTER SYSTEM SET statements	The ALTER SYSTEM SET statement can dynamically set an initialization parameter in one or more containers in an application container.	<a href="#">"Modifying a CDB with ALTER SYSTEM"</a>
Issuing data definition language (DDL) statements	In an application container, some DDL statements can apply to all containers in the application container or to the current container only.	<a href="#">"Modifying Application Common Objects with DDL Statements"</a>

The following table describes administrative tasks for application containers that are similar to administrative tasks that manage a PDB.

**Table 17-2 Application Container Administrative Tasks Similar to Those of a PDB**

Administrative Task	Description	More Information
Connecting to the application root	The application root has its own service name, and users can connect to the application root in the same way that they connect to a PDB. Similarly, each application PDB has its own service name, and the application seed has its own service name.	<a href="#">"Accessing a Container in a CDB"</a>
Issuing the ALTER PLUGGABLE DATABASE statement	An ALTER PLUGGABLE DATABASE statement can modify an application root, application PDB, and application seed in the same way it modifies a PDB. For example, an administrator can open or close an application root with an ALTER PLUGGABLE DATABASE statement.	<a href="#">"Modifying Containers When Connected to the CDB Root"</a> <a href="#">"Modifying a PDB at the Database Level"</a>

**Table 17-2 (Cont.) Application Container Administrative Tasks Similar to Those of a PDB**

Administrative Task	Description	More Information
Issuing the SQL*Plus STARTUP and SHUTDOWN commands	SQL*Plus STARTUP and SHUTDOWN commands operate on an application root, application PDB, and application seed in the same way that they operate on a PDB.	<a href="#">"Modifying the Open Mode of One or More PDBs"</a>
Issuing the ALTER SYSTEM statements	An ALTER SYSTEM statement operates on an application root, application PDB, and application seed in the same way that it operates on a PDB.	<a href="#">"Modifying a CDB with ALTER SYSTEM"</a> <a href="#">"Modifying a PDB at the System Level"</a>
Managing tablespaces	Administrators can create, modify, and drop tablespaces for an application root and for application PDBs. Each container has its own tablespaces.	<a href="#">"About Managing Tablespaces in a CDB"</a>
Managing data files and temp files	Administrators can create, modify, and drop data files and temp files for an application root and for application PDBs. Each container has its own files.	<i>Oracle Database Administrator's Guide</i> for information about managing data files and temp files
Managing schema objects	You can create, modify, and drop schema objects in an application root and in each application PDB in the same way that you would in a PDB. You can also create triggers that fire for a specific application root or application PDB.  However, application containers support application common objects, which can be shared between the containers in an application container. Application common objects cannot be created in PDBs.	<a href="#">"Managing Application Common Objects"</a>

This section contains the following topics:

## 17.2 About Modifying an Application Root

The ALTER DATABASE statement can modify an application root. The ALTER PLUGGABLE DATABASE statement can modify the open mode of application PDBs.

The following table lists which containers are modified by clauses in `ALTER DATABASE` and `ALTER PLUGGABLE DATABASE` statements issued in an application root. The table also lists statements that are not allowed in an application root.

 **Note:**

Statements issued when the current container is the application root never affect the CDB root or PDBs that do not belong to the current application root.

**Table 17-3 Statements That Modify Containers in an Application Root**

Modify Application Root Only	Modify One or More Application PDBs	Cannot Be Issued in an Application Root
<p>When connected as an application common user whose current container is the application root, <code>ALTER DATABASE</code> statements with the following clauses modify the application root only:</p> <ul style="list-style-type: none"> <li>• <i>database_file_clauses</i></li> <li>• <code>DEFAULT EDITION</code> clause</li> <li>• <code>DEFAULT TABLESPACE</code> clause</li> <li>• <code>DEFAULT TEMPORARY TABLESPACE</code> clause</li> </ul> <p><code>ALTER DATABASE</code> statements with the following clauses modify the application root and set default values for application PDBs:</p> <ul style="list-style-type: none"> <li>• <i>flashback_mode_clause</i></li> <li>• <code>SET DEFAULT {BIGFILE   SMALLFILE} TABLESPACE</code> clause</li> <li>• <i>set_time_zone_clause</i></li> </ul> <p>You can use these clauses to set nondefault values for specific application PDBs.</p>	<p>When connected as an application common user whose current container is the application root, <code>ALTER PLUGGABLE DATABASE</code> statements with the following clause can modify the open mode of one or more application PDBs:</p> <ul style="list-style-type: none"> <li>• <i>pdb_change_state</i></li> </ul> <p>When the current container is an application PDB, <code>ALTER PLUGGABLE DATABASE</code> statements with this clause can modify the open mode of the current application PDB.</p> <p>When connected as an application common user whose current container is the application root, <code>ALTER PLUGGABLE DATABASE</code> statements with the following clause can preserve or discard the open mode an application PDB when the CDB restarts:</p> <ul style="list-style-type: none"> <li>• <i>pdb_save_or_discard_state</i></li> </ul>	<p>When connected as an application common user whose current container is the application root, <code>ALTER DATABASE</code> statements with the following clauses are not allowed:</p> <ul style="list-style-type: none"> <li>• <i>startup_clauses</i></li> <li>• <i>recovery_clauses</i></li> <li>• <i>logfile_clauses</i></li> <li>• <i>controlfile_clauses</i></li> <li>• <i>standby_database_clauses</i></li> <li>• <i>instance_clauses</i></li> <li>• <i>security_clause</i></li> <li>• <code>RENAME GLOBAL_NAME</code> clause</li> <li>• <code>ENABLE BLOCK CHANGE TRACKING</code> clause</li> <li>• <code>DISABLE BLOCK CHANGE TRACKING</code> clause</li> </ul>

 **See Also:**

- ["About the Current Container"](#)
- ["Modifying a PDB at the Database Level"](#)
- [Oracle Database SQL Language Reference](#)

## 17.3 Managing Applications in an Application Container

You install, upgrade, or patch an application in an application container.

You can also uninstall an application from an application container. You perform these operations in the application root. The application container propagates the application changes to the application PDBs when the application PDBs synchronize with the application in the application root.

This section contains the following topics:

- [About Application Management](#)  
In an application container, an **application** is a named, versioned set of application metadata and common data. The application is stored in the application root.
- [Installing Applications in an Application Container](#)  
You can install an application in an application container.
- [Upgrading Applications in an Application Container](#)  
Major changes to an application constitute application upgrades. You can upgrade an application in an application container.
- [Patching Applications in an Application Container](#)  
Minor changes to an application constitute application patches.
- [Migrating an Existing Application to an Application Container](#)  
You can migrate an application that is installed in a PDB to an application container.
- [Synchronizing Applications in an Application PDB](#)  
Synchronizing an application updates the application in the application PDB to the latest version and patch in the application root.
- [Synchronizing an Application Root Replica with a Proxy PDB](#)  
When application containers in different CDBs have the same application, their application roots can be kept synchronized by creating a master application root, a replica application root, and a proxy PDB.
- [Setting the Compatibility Version of an Application](#)  
The compatibility version of an application is the earliest version of the application possible for the application PDBs that belong to the application container.
- [Performing Bulk Inserts During Application Install, Upgrade, and Patch Operations](#)  
SQL\*Loader is the only supported utility for bulk inserts into tables during application install, upgrade, and patch operations. Only conventional path loads are supported for bulk inserts during application install, upgrade, and patch operations.
- [Uninstalling Applications from an Application Container](#)  
You can uninstall an application in an application container.

### Related Topics

- [Overview of Applications in an Application Container](#)  
Within an application container, an **application** is the named, versioned set of common data and metadata stored in the application root.

## 17.3.1 About Application Management

In an application container, an **application** is a named, versioned set of application metadata and common data. The application is stored in the application root.

In this context, the term “application” means “application back-end.” Application common objects include user accounts, tables, PL/SQL packages, and so on. You can share an application with the application PDBs that belong to the application root. When you perform application changes, application PDBs can synchronize with the application in the application root.

This section contains the following topics:

i

- [Basic Steps of Application Maintenance](#)  
You can install, upgrade, and patch an application in an application root.
- [Application Versions](#)  
The application container also manages the versions of the application and the patches to the application.
- [Application Module Names](#)  
The application module name is set by the `DBMS_APPLICATION_INFO.SET_MODULE` procedure or the equivalent OCI attribute setting.

### 17.3.1.1 Basic Steps of Application Maintenance

You can install, upgrade, and patch an application in an application root.

You must issue an `ALTER PLUGGABLE DATABASE ... BEGIN` statement to start the operation and an `ALTER PLUGGABLE DATABASE ... END` statement to end the operation. You can issue these statements in the same user session or in different user sessions.

The following is the typical process for creating and maintaining an application in an application container:

1. Create the application container.
2. Install the application in the application root using `ALTER PLUGGABLE DATABASE ... BEGIN INSTALL`.

This step includes creating the application data model and configuring the application common users and application common objects.



#### Note:

SQL\*Loader is the only supported utility for bulk inserts into tables during application install, upgrade, and patch operations.

3. Create the application PDBs in the application root.
4. Synchronize each application PDB that should install the application with the application root. The statement is `ALTER PLUGGABLE DATABASE APPLICATION ... SYNC`.

5. Load the data for each application PDB.
6. Maintain the application. Upgrade using `ALTER PLUGGABLE DATABASE ... BEGIN UPGRADE`, and patch using `ALTER PLUGGABLE DATABASE ... BEGIN PATCH`.
7. Synchronize application PDBs that should apply changes from upgrades and patches.
8. Add new application PDBs whenever necessary.
9. If necessary, uninstall the application using `ALTER PLUGGABLE DATABASE ... BEGIN UNINSTALL`.

 **See Also:**

- ["Creating Application Containers"](#)
- *Oracle Database Security Guide* to learn how to audit application maintenance operations

### 17.3.1.2 Application Versions

The application container also manages the versions of the application and the patches to the application.

The application container manages versions as follows:

- When you install an application, you must specify the application version number.
- When you upgrade an application, you must specify the old application version number and the new application version number.
- When you patch an application, you must specify the minimum application version number for the patch and the patch number.

As the application evolves, the application container maintains all of the versions and patch changes that you apply.

You can also configure the application container so that different application PDBs use different application versions. For example, if you provide an application to various customers, and each customer has its own application PDB, some customers might wait longer to upgrade the application. In this case, some application PDBs can use the latest version of the application, whereas other application PDBs can use an older version of the application.

### 17.3.1.3 Application Module Names

The application module name is set by the `DBMS_APPLICATION_INFO.SET_MODULE` procedure or the equivalent OCI attribute setting.

The module name is necessary during application maintenance because of other activity that might be occurring in the database. For example, statements issued by background processes should not be captured in the application capture tables. Also, other users might execute statements that are unrelated to the application. A module name check distinguishes what should be captured from what should not be captured.



Only sessions whose module name matches the module name of the session where APPLICATION BEGIN was issued are considered for capture.

Some clauses, such as the SHARING clause, are valid only when issued between an ALTER PLUGGABLE DATABASE ... BEGIN statement and an ALTER PLUGGABLE DATABASE ... END statement. For these clauses, if the module name for a session does not match, then this session is not included in between the BEGIN and END statements, causing statements that include the clause to fail with ORA-65021 or other errors.

The most common cause for a module name mismatch is the default module name. For example, SQL\*Plus sets a default module name when a connection is made to the database. A connection as a SYSDBA user results in one default module name (for example, sqlplus@host1 (TNS V1-V3)), whereas a connection as a non-SYSDBA user results in a different default module name (for example, SQL\*Plus). When SYSDBA and non-SYSDBA users are both performing maintenance, you must explicitly set the module name in each session to the same value, and not rely the default settings in SQL\*Plus.

### Example 17-1 Checking the Application Module Name

This example shows how the default module name changes depending on whether the connected user has SYSDBA privileges.

```
SQL> CONNECT / AS SYSDBA
Connected.
```

```
SQL> select module from v$session where auid =
SYS_CONTEXT('USERENV','sessionid');
```

MODULE

```
-----
sqlplus@host1 (TNS V1-V3)
```

```
SQL> CONNECT dba1
Password: *****
Connected.
```

```
SQL> select module from v$session where auid =
SYS_CONTEXT('USERENV','sessionid');
```

MODULE

```
-----
SQL*Plus
```

#### See Also:

*Oracle Database PL/SQL Packages and Types Reference* to learn how to set the application module name

## 17.3.2 Installing Applications in an Application Container

You can install an application in an application container.

This section contains the following topics:

- [About Installing Applications in an Application Container](#)  
You issue `ALTER PLUGGABLE DATABASE APPLICATION` statements to install an application in the application root.
- [Installing an Application in an Application Container with Automated Propagation](#)  
In automated propagation, the application is installed in the application PDBs that synchronize with the application in the application root.

### 17.3.2.1 About Installing Applications in an Application Container

You issue `ALTER PLUGGABLE DATABASE APPLICATION` statements to install an application in the application root.

You install the application in the application root only. Application PDBs that synchronize with the application install the application automatically. With the automated method, you can perform the installation using one or more of the following techniques: scripts, SQL statements, and graphical user interface tools.

Start of the installation with an `ALTER PLUGGABLE DATABASE APPLICATION BEGIN INSTALL` statement and the end of the install with an `ALTER PLUGGABLE DATABASE APPLICATION END INSTALL` statement. Each installation must be associated with an application name and version number, which are specified in the `ALTER PLUGGABLE DATABASE APPLICATION` statements.

#### Related Topics

- [Running Oracle-Supplied SQL Scripts in a CDB](#)  
You can use the `catcon.pl` script to run Oracle-supplied SQL or SQL scripts within a CDB. You can run the script against any specified containers.

### 17.3.2.2 Installing an Application in an Application Container with Automated Propagation

In automated propagation, the application is installed in the application PDBs that synchronize with the application in the application root.

#### Prerequisites

You must meet the following prerequisites:

- The current user must have the `ALTER PLUGGABLE DATABASE` system privilege, and the privilege must be commonly granted in the application root.
- The application root must be in open read/write.

#### To install an application using automated propagation:

1. In SQL\*Plus or SQL Developer, ensure that the current container is a PDB.

2. Run the ALTER PLUGGABLE DATABASE APPLICATION BEGIN INSTALL statement in the following form:

```
ALTER PLUGGABLE DATABASE APPLICATION application_name BEGIN INSTALL  
'application_version_number';
```

For example, run the following statement if the *application\_name* is salesapp and the *application\_version\_number* is 4.2:

```
ALTER PLUGGABLE DATABASE APPLICATION salesapp BEGIN INSTALL '4.2';
```

3. Install the application using scripts, SQL statements, or graphical user interface tools.
4. Run the ALTER PLUGGABLE DATABASE APPLICATION END INSTALL statement in the following form:

```
ALTER PLUGGABLE DATABASE APPLICATION application_name END INSTALL  
'application_version_number';
```

For example, run the following statement if the *application\_name* is salesapp and the *application\_version\_number* is 4.2:

```
ALTER PLUGGABLE DATABASE APPLICATION salesapp END INSTALL '4.2';
```

 **Note:**

Ensure that the *application\_name* and *application\_version\_number* match in the ALTER PLUGGABLE DATABASE APPLICATION BEGIN INSTALL statement and the ALTER PLUGGABLE DATABASE APPLICATION END INSTALL statement.

5. Synchronize all of the application PDBs that must install the application by issuing an ALTER PLUGGABLE DATABASE APPLICATION statement with the SYNC clause.

#### Related Topics

- [Accessing a Container in a CDB](#)  
Access a container in a CDB with SQL\*Plus by issuing a CONNECT or ALTER SESSION command.
- [Synchronizing Applications in an Application PDB](#)  
Synchronizing an application updates the application in the application PDB to the latest version and patch in the application root.

## 17.3.3 Upgrading Applications in an Application Container

Major changes to an application constitute application upgrades. You can upgrade an application in an application container.

This section contains the following topics:

- [About Upgrading Applications in an Application Container](#)  
You issue `ALTER PLUGGABLE DATABASE APPLICATION` statements to upgrade an application in the application root.
- [Upgrading an Application in an Application Container](#)  
After an upgrade, application changes caused by the upgrade propagate to the application PDBs that synchronize with the application root.

### 17.3.3.1 About Upgrading Applications in an Application Container

You issue `ALTER PLUGGABLE DATABASE APPLICATION` statements to upgrade an application in the application root.

You upgrade the application in the application root only, and application PDBs apply the changes in the upgrade when they synchronize with the application. Application PDBs synchronize with an application by running an `ALTER PLUGGABLE DATABASE` statement with the `SYNC` clause. You can upgrade using one or more of the following techniques: scripts, SQL statements, and graphical user interface tools.

Indicate the start of the upgrade with an `ALTER PLUGGABLE DATABASE APPLICATION BEGIN UPGRADE` statement and the end of the upgrade with an `ALTER PLUGGABLE DATABASE APPLICATION END UPGRADE` statement. Each upgrade must be associated with an application name, starting version number, and ending version number, which are specified in the `ALTER PLUGGABLE DATABASE APPLICATION` statements.

When you upgrade an application, Oracle Database automatically clones the application root. During the upgrade, application PDBs point to the clone. Applications continue to run during the upgrade. Application PDBs can perform DML on metadata-linked and extended data-linked tables and views. Application PDBs can query metadata-linked objects, extended data-linked objects, and data-linked objects.

After the upgrade, the application root clone remains and continues to support any application PDB that still uses the preupgrade version of the application in the clone. Application PDBs that upgrade are pointed to the upgraded application root. Application PDBs that do not upgrade might continue to use the clone, and application PDBs that are plugged into the application root might also use the same application version as the clone.



**Note:**

Unlike an application upgrade, a patch does not create an application root clone. If an application PDB is not synchronized after a patch, then queries are directed to the application root, which has already been patched.

The following figure illustrates the upgrade process.

**Figure 17-1 Upgrading Applications in an Application Container**

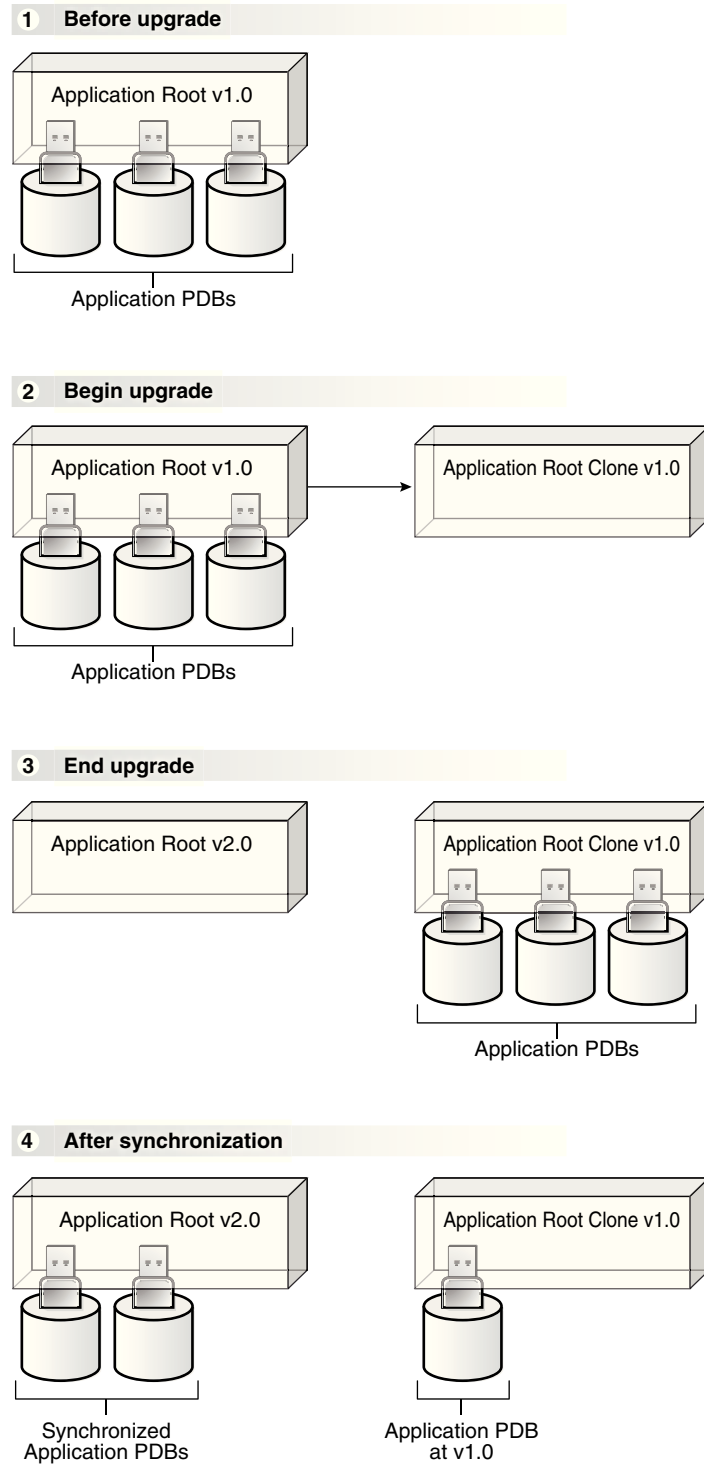

 **Note:**

When the application root is in any open mode, the application root clone is in read-only mode. When the application root is closed, the application root clone is also closed.

**Related Topics**

- [Running Oracle-Supplied SQL Scripts in a CDB](#)  
You can use the `catcon.pl` script to run Oracle-supplied SQL or SQL scripts within a CDB. You can run the script against any specified containers.

### 17.3.3.2 Upgrading an Application in an Application Container

After an upgrade, application changes caused by the upgrade propagate to the application PDBs that synchronize with the application root.

**Prerequisites**

- The CDB must be in local undo mode.
- The current user must have the `ALTER PLUGGABLE DATABASE` system privilege, and the privilege must be commonly granted in the application root.
- The application root must be in open read/write.

**To upgrade an application in an application container:**

1. In SQL\*Plus or SQL Developer, ensure that the current container is the application root.
2. Run the `ALTER PLUGGABLE DATABASE APPLICATION BEGIN UPGRADE` statement in the following form:

```
ALTER PLUGGABLE DATABASE APPLICATION application_name BEGIN UPGRADE  
'application_start_version_number' TO 'application_end_version_number';
```

For example, run the following statement if the *application\_name* is `salesapp`, the *application\_start\_version\_number* is 4.2, and the *application\_end\_version\_number* is 4.3:

```
ALTER PLUGGABLE DATABASE APPLICATION salesapp BEGIN UPGRADE '4.2' TO  
'4.3';
```

3. Upgrade the application using scripts, SQL statements, or graphical user interface tools.
4. Run the `ALTER PLUGGABLE DATABASE APPLICATION END UPGRADE` statement in the following form:

```
ALTER PLUGGABLE DATABASE APPLICATION application_name END UPGRADE TO  
'application_end_version_number';
```

For example, run the following statement if the *application\_name* is `salesapp` and the *application\_end\_version\_number* is 4.3:

```
ALTER PLUGGABLE DATABASE APPLICATION salesapp END UPGRADE TO '4.3';
```

 **Note:**

Ensure that the *application\_name* and *application\_end\_version\_number* match in the `ALTER PLUGGABLE DATABASE APPLICATION BEGIN UPGRADE` statement and the `ALTER PLUGGABLE DATABASE APPLICATION END UPGRADE` statement.

5. Synchronize all of the application PDBs that must upgrade the application by issuing an `ALTER PLUGGABLE DATABASE APPLICATION` statement with the `SYNC` clause.

#### Related Topics

- [Accessing a Container in a CDB](#)  
Access a container in a CDB with SQL\*Plus by issuing a `CONNECT` or `ALTER SESSION` command.
- [Synchronizing Applications in an Application PDB](#)  
Synchronizing an application updates the application in the application PDB to the latest version and patch in the application root.
- [Setting the Undo Mode in a CDB Using ALTER DATABASE](#)  
When local undo is enabled, each container has its own undo tablespace for every instance in which it is open. When local undo is disabled, there is one undo tablespace for the entire CDB.

## 17.3.4 Patching Applications in an Application Container

Minor changes to an application constitute application patches.

Examples of minor changes can include bug fixes and security patches. You can patch an application in an application container.

This section contains the following topics:

- [About Patching Applications in an Application Container](#)  
To patch an application in the application root, issue `ALTER PLUGGABLE DATABASE APPLICATION` statements.
- [Patching an Application in an Application Container with Automated Propagation](#)  
Application changes for the patch are propagated to the application PDBs that synchronize with the application in the application root.

### 17.3.4.1 About Patching Applications in an Application Container

To patch an application in the application root, issue `ALTER PLUGGABLE DATABASE APPLICATION` statements.

You patch the application in the application root only. The application PDBs that synchronize with the application apply the changes. You can perform the patch using

one or more of the following techniques: scripts, SQL statements, and graphical user interface tools.

The patch is restricted to a small set of operations. In general, destructive operations, such as dropping a table, are not allowed in a patch. If you attempt to patch an application, and the operation raises an “operation not supported in an application patch” error, then upgrade the application instead of patching it to make the necessary changes.

 **Note:**

Unlike an application upgrade, a patch does not create an application root clone. If an application PDB is not synchronized after a patch, then queries are directed to the application root, which has already been patched.

Indicate the start of the patch with an `ALTER PLUGGABLE DATABASE APPLICATION BEGIN PATCH` statement and the end of the patch with an `ALTER PLUGGABLE DATABASE APPLICATION END PATCH` statement. Each patch must be associated with an application name, starting version number, and ending version number. Specify these values in the `ALTER PLUGGABLE DATABASE APPLICATION` statements.

### Related Topics

- [Running Oracle-Supplied SQL Scripts in a CDB](#)  
You can use the `catcon.pl` script to run Oracle-supplied SQL or SQL scripts within a CDB. You can run the script against any specified containers.
- [Upgrading Applications in an Application Container](#)  
Major changes to an application constitute application upgrades. You can upgrade an application in an application container.

## 17.3.4.2 Patching an Application in an Application Container with Automated Propagation

Application changes for the patch are propagated to the application PDBs that synchronize with the application in the application root.

### Prerequisites

The following prerequisites must be met:

- The current user must have the `ALTER PLUGGABLE DATABASE` system privilege, and the privilege must be commonly granted in the application root.
  - The application root must be in open read/write mode.
1. In SQL\*Plus, ensure that the current container is the application root.
  2. Run the `ALTER PLUGGABLE DATABASE APPLICATION BEGIN PATCH` statement in the following form:

```
ALTER PLUGGABLE DATABASE APPLICATION application_name BEGIN PATCH  
patch_number MINIMUM VERSION 'minimum_application_version_number';
```

For example, run the following statement if the *application\_name* is `salesapp`, the *patch\_number* is `987654`, and the *minimum\_application\_version\_number* is `4.2`:



```
ALTER PLUGGABLE DATABASE APPLICATION salesapp BEGIN PATCH 987654  
MINIMUM VERSION '4.2';
```

The *minimum\_application\_version\_number* indicates the minimum application version at which an application installation must be before the patch can be applied to it.

3. Patch the application using scripts, SQL statements, and graphical user interface tools.
4. Run the ALTER PLUGGABLE DATABASE APPLICATION END PATCH statement in the following form:

```
ALTER PLUGGABLE DATABASE APPLICATION application_name END PATCH  
patch_number;
```

For example, run the following statement if the *application\_name* is salesapp and the *patch\_number* is 987654:

```
ALTER PLUGGABLE DATABASE APPLICATION salesapp END PATCH 987654;
```

 **Note:**

Ensure that the *application\_name* and *patch\_number* match in the ALTER PLUGGABLE DATABASE APPLICATION BEGIN PATCH statement and the ALTER PLUGGABLE DATABASE APPLICATION END PATCH statement.

5. Synchronize all of the application PDBs that must patch the application by issuing an ALTER PLUGGABLE DATABASE APPLICATION statement with the SYNC clause.

### Related Topics

- [Accessing a Container in a CDB](#)  
Access a container in a CDB with SQL\*Plus by issuing a CONNECT or ALTER SESSION command.
- [Synchronizing Applications in an Application PDB](#)  
Synchronizing an application updates the application in the application PDB to the latest version and patch in the application root.

## 17.3.5 Migrating an Existing Application to an Application Container

You can migrate an application that is installed in a PDB to an application container.

You can migrate the application to the application root or to an application PDB. For example, you might migrate an application installed in a PDB plugged into an Oracle Database 12c Release 2 (12.2) CDB to an application container in an Oracle Database 18c CDB.

This section contains the following topics:

- [About Migrating an Existing Application to an Application Container](#)  
You can migrate an application to an application root by creating an application root using an existing PDB.
- [Creating an Application Root Using an Existing PDB](#)  
Migrate an application that is installed in a PDB by copying the PDB to an application container.

- [Creating an Application PDB Using an Existing PDB](#)  
After migrating an existing application to an application root, you can use an existing PDB that uses the application to create an application PDB.

### 17.3.5.1 About Migrating an Existing Application to an Application Container

You can migrate an application to an application root by creating an application root using an existing PDB.

If the application is installed in more than one PDB, then you can use one of the PDBs to create the application root. You can use one of the methods available for copying a PDB to an application root, such as cloning the PDB or plugging in the PDB as an application root.

When common users, roles, or profiles exist in the PDB used to create the application root, you must run procedures in the `DBMS_PDB` package to associate them with the application. When an application root created from a PDB is first opened, each local user, role, and profile is marked as common. The procedures in the `DBMS_PDB` package associate the user, role, or profile with the application. Therefore, all DDL operations on the user, role, or profile must subsequently be done within an application `BEGIN . . . END` block of this application.

When shared database objects exist in the application root, you must run procedures in the `DBMS_PDB` package to associate the database objects with the application as application common objects. Therefore, all DDL operations on the application common objects must subsequently be done within an application `BEGIN . . . END` block of this application.

After the application root is in place, you can create application PDBs in the new application container using the existing PDBs. The application PDBs that you create must contain the application objects, including their data. Additional steps are necessary to synchronize the application version and patch number and to establish shared database objects in the application PDBs.

#### Scenario with One Hundred PDBs Running the Same Application

Assume that you currently have one hundred PDBs that are running the same application, and you want to migrate these PDBs to an application container. These PDBs have the application common objects and common users, roles, and profiles required by the application. To migrate the PDBs to an application container, follow these steps:

1. Choose one of the PDBs, and use the instructions in "[Creating an Application Root Using an Existing PDB](#)" to create the application root with this PDB.  
As part of this step, you associate the database objects, users, roles, and profiles with the application by running procedures in the `DBMS_PDB` package.
2. Use the instructions in "[Creating an Application PDB Using an Existing PDB](#)" to create one hundred application PDBs using the PDBs that are running the application.

 **See Also:**

- ["Creating an Application Container"](#)
- ["Installing an Application in an Application Container with Automated Propagation"](#)
- *Oracle Database PL/SQL Packages and Types Reference* to learn more about DBMS\_PDB

### 17.3.5.2 Creating an Application Root Using an Existing PDB

Migrate an application that is installed in a PDB by copying the PDB to an application container.

#### Prerequisites

An Oracle Database 12c Release 2 (12.2) or later CDB must exist.

1. In the CDB, create the application root by cloning the existing PDB, relocating the existing PDB, or by unplugging and plugging in the existing PDB.

The new application root must contain all database objects used by the application.

2. With the application root as the current container, start an application installation operation by issuing an `ALTER PLUGGABLE DATABASE ... BEGIN INSTALL` statement.
3. Optional: Query the `COMMON` column in the `DBA_USERS`, `DBA_ROLES`, and `DBA_PROFILES` views to determine which users, roles, and profiles are common.
4. Run the following procedures in the `DBMS_PDB` package to associate users, roles, and profiles with the application:
  - Run the `SET_USER_EXPLICIT` procedure to set application common users.
  - Run the `SET_ROLE_EXPLICIT` procedure to set application common roles.
  - Run the `SET_PROFILE_EXPLICIT` procedure to set application common profiles.

If you do not have `EXECUTE` privilege on the `DBMS_PDB` package, then you can run these procedures in the `DBMS_PDB_ALTER_SHARING` package.

5. Optional: With the application root as the current container, query the `SHARING` column in the `DBA_OBJECTS` view to determine which database objects are shared.
6. Run the following procedures in the `DBMS_PDB` package to associate database objects with the application:
  - Run the `SET_DATA_LINKED` procedure to set data-linked application common objects.
  - Run the `SET_METADATA_LINKED` procedure to set metadata-linked application common objects.
  - Run the `SET_EXT_DATA_LINKED` procedure to set extended data-linked application common objects.

If you do not have `EXECUTE` privilege on the `DBMS_PDB` package, then you can run these procedures in the `DBMS_PDB_ALTER_SHARING` package.

7. End the application installation operation by issuing an `ALTER PLUGGABLE DATABASE ... END INSTALL` statement.
8. Optional: Rerun the queries that you ran previously to ensure that the sharing properties of the database objects are correct and that the common properties of the users, roles, and profiles are correct.
9. Optional: If existing PDBs use the application, then create application PDBs using these existing PDBs.

See "[Creating an Application PDB Using an Existing PDB](#)".

#### Related Topics

- [Creating an Application Container](#)  
You can create an application container using the `CREATE PLUGGABLE DATABASE` statement with the `AS APPLICATION CONTAINER` clause.
- [Managing Applications in an Application Container](#)  
You install, upgrade, or patch an application in an application container.
- *Oracle Database PL/SQL Packages and Types Reference*

### 17.3.5.3 Creating an Application PDB Using an Existing PDB

After migrating an existing application to an application root, you can use an existing PDB that uses the application to create an application PDB.

#### Prerequisites

You must meet the following prerequisites:

- An Oracle Database 12c Release 2 (12.2) or later CDB must exist, and the application root to which the application PDB will belong must exist.
  - The PDB must contain all application common objects used by the application.
  - The application must be installed in the application root.
1. In the application root, create the application PDB by cloning the existing PDB or by unplugging and plugging in the existing PDB.  
Violations will be reported during PDB creation.
  2. Connect to or switch to the new PDB as a user with the required privileges.
  3. Run the `pdb_to_apppdb.sql` script in the `ORACLE_HOME/rdbms/admin` directory.  
The script automatically synchronizes the application PDB with the application root.
  4. Optional: Query the `SHARING` column in the `DBA_OBJECTS` view to ensure that the sharing properties of the database objects are correct.
  5. Optional: Query the `COMMON` column in the `DBA_USERS`, `DBA_ROLES`, and `DBA_PROFILES` views to ensure that the common properties of the users, roles, and profiles are correct.

## Related Topics

- [Creating and Removing PDBs and Application Containers](#)  
You can create PDBs, application containers, and application seeds using a variety of techniques.

## 17.3.6 Synchronizing Applications in an Application PDB

Synchronizing an application updates the application in the application PDB to the latest version and patch in the application root.

### Note:

When an application is installed, upgraded, patched, or uninstalled in an application root, an application PDB that belongs to the application root is not changed until it is synchronized.

In addition to user-created applications, application containers can also contain implicitly created applications. An application is created implicitly in an application root when an application common user operation is issued with a `CONTAINER=ALL` clause outside of `ALTER PLUGGABLE DATABASE BEGIN/END` statements. Application common user operations include operations such as creating a common user with a `CREATE USER` statement or altering a common user with an `ALTER USER` statement. An implicit application is named `APP$guid`, where `guid` is the GUID of the application root. An implicit application is created when the application root is opened for the first time.

Synchronize one application in an application PDB by issuing the following SQL statement when the application PDB is the current container, where `application_name` is the name of the application:

```
ALTER PLUGGABLE DATABASE APPLICATION application_name SYNC;
```

Synchronize all of the applications in an application PDB, including implicitly created applications, by issuing the following SQL statement when the application PDB is the current container:

```
ALTER PLUGGABLE DATABASE APPLICATION ALL SYNC;
```

Synchronize implicitly created applications in an application PDB by issuing one of the following SQL statements when the application PDB is the current container:

- `ALTER PLUGGABLE DATABASE APPLICATION APP$guid SYNC;`

`guid` is the GUID of the application root.

- `ALTER PLUGGABLE DATABASE APPLICATION APP$CON SYNC;`

`APP$CON` is a logical application name that Oracle Database automatically translates to the real name of the implicit application.

## Prerequisites

The current user must have `ALTER PLUGGABLE DATABASE` system privilege.

1. In SQL\*Plus, ensure that the current container is the application PDB.

2. Run an `ALTER PLUGGABLE DATABASE APPLICATION` statement with the `SYNC` clause.

**Example 17-2 Synchronizing a Specific Application in an Application PDB**

This example synchronizes an application named `salesapp` with the latest application changes in the application root.

```
ALTER PLUGGABLE DATABASE APPLICATION salesapp SYNC;
```

**Example 17-3 Synchronizing All of the Applications in an Application PDB**

This example synchronizes all of the applications in an application PDB with the latest application changes in the application root.

```
ALTER PLUGGABLE DATABASE APPLICATION ALL SYNC;
```

**Example 17-4 Synchronizing Implicitly-Created Applications in an Application PDB**

This example synchronizes all of the implicitly-created applications in an application PDB with the latest application changes to the implicitly created applications in the application root.

```
ALTER PLUGGABLE DATABASE APPLICATION APP$CON SYNC;
```

## 17.3.7 Synchronizing an Application Root Replica with a Proxy PDB

When application containers in different CDBs have the same application, their application roots can be kept synchronized by creating a master application root, a replica application root, and a proxy PDB.

This section contains the following topics:

- [About Synchronizing an Application Root Replica with a Proxy PDB](#)  
A proxy PDB can synchronize an application root and a replica of the application root.
- [Creating a Proxy PDB That References an Application Root Replica](#)  
When multiple application containers run the same application, the application in the application containers can be kept synchronized using proxy PDBs.

### 17.3.7.1 About Synchronizing an Application Root Replica with a Proxy PDB

A proxy PDB can synchronize an application root and a replica of the application root.

An application might be installed in several application containers. Installing, upgrading, and patching the application are more efficient when you use proxy PDBs.

In this configuration, one application container has the master application root. The master application root is where you install, upgrade, and patch the application. Application root replicas are exact copies of the master application root. Each application root replica is referenced by a proxy PDB in the master application root.

When a proxy PDB is synchronized with the application changes in the master application root, it propagates the changes to its referenced application root replica. After the application root replica is synchronized, application PDBs that are plugged

into the application root replica can synchronize with the replica and in this way receive the changes.

The following figure shows a configuration that synchronizes an application root replica using a proxy PDB.

Figure 17-2 Synchronizing an Application Root Replica with a Proxy PDB

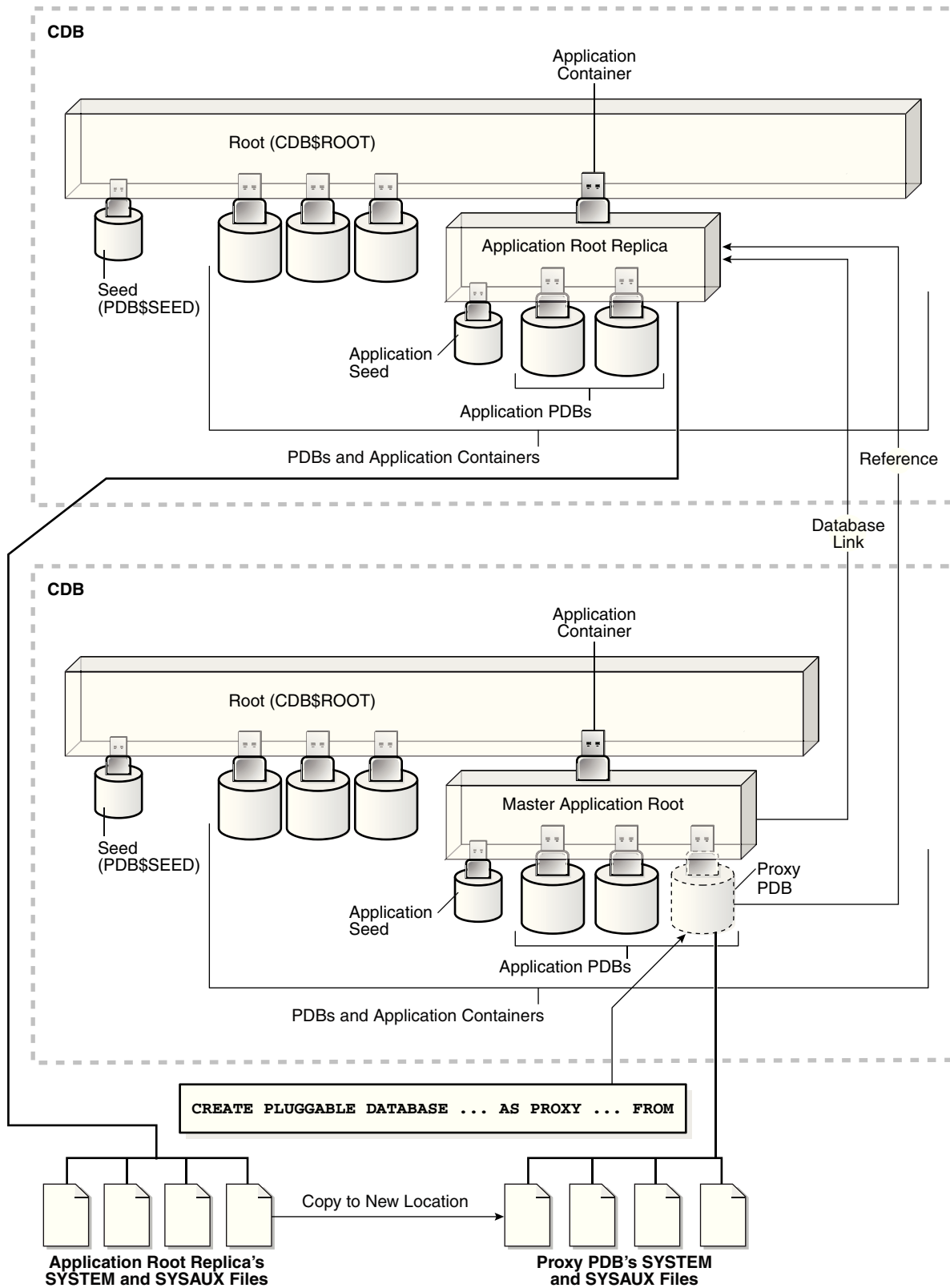



In addition, when an application root replica is configured and has its own application PDBs, a query that includes the `CONTAINERS` clause in the master application root can return data from the current application container and from the application container with the application root replica. The query can show results from the application root replica and from any open application PDBs plugged into the replica.



#### See Also:

["Querying Application Common Objects Across Application PDBs"](#)

### 17.3.7.2 Creating a Proxy PDB That References an Application Root Replica

When multiple application containers run the same application, the application in the application containers can be kept synchronized using proxy PDBs.

1. Create the application container with the master application root by using a `CREATE PLUGGABLE DATABASE` statement.

Install the application in the application container now or later.

2. Create the application container with the application root replica in one of the following ways:
  - Create an empty application container using any supported method.
  - Clone the master application root.

If the port of the listener used by the application root replica is not 1521, then a `PORT` clause is required during creation. If the host of the application root replica is different from the host of the master application root, then a `HOST` clause is required during creation.

This application root replica will be referenced by the proxy PDB.

3. In the master application root, create a proxy PDB that references the application root replica that you created in the previous step.
4. Open and synchronize the proxy PDB.

When the proxy PDB is synchronized, it propagates the changes in the master application root to the application root replica.

5. Optional: In the master application root, modify the application by installing, upgrading, or patching it.
6. Optional: Synchronize the proxy PDB with the application changes in the master application root by running the `ALTER PLUGGABLE DATABASE APPLICATION` statement with the `SYNC` clause.

When the proxy PDB is synchronized, it propagates the changes in the master application root to the application root replica.

#### **Example 17-5 Synchronizing an Application Root Replica with a Proxy PDB**

This example assumes that two CDBs exist: `hqdb` and `depdb`. The goal is to keep the same application synchronized in an application container in each CDB. To accomplish this goal, this example configures the following application containers:

- The `hqdb` CDB contains the application container with the master application root called `msappcon`.
  - An application called `sampleapp` is installed in the `msappcon` master application root.
  - The `msappcon` application root contains two application PDBs named `mispdb1` and `mispdb2`.
  - The `msappcon` application root also contains a proxy PDB named `prxypdb` that references the application root replica in the other CDB.
- The `depdb` CDB contains the application container with the application root replica called `depappcon`.
  - An application called `sampleapp` is propagated from the proxy PDB `prxypdb` in the `msappcon` master application root and installed in the `depappcon` master application root.
  - The `depappcon` application root contains two application PDBs named `deppdb1` and `deppdb2`.

This example shows how changes to the `sampleapp` application in the `msappcon` master application root are applied to the application PDBs in both CDBs when the application PDBs are synchronized.

1. Create the application container with the master application root in the `hqdb` CDB.
  - a. In SQL\*Plus, ensure that the current container is the `hqdb` CDB root.
  - b. Create the application container from the PDB seed with the following statement:

```
CREATE PLUGGABLE DATABASE msappcon
  AS APPLICATION CONTAINER
  ADMIN USER msappconadm IDENTIFIED BY password STORAGE (MAXSIZE
2G)
  DEFAULT TABLESPACE appcontbs
  DATAFILE '/disk1/oracle/dbs/mssappcon/msappcon01.dbf' SIZE 250M
  AUTOEXTEND ON
  FILE_NAME_CONVERT = ('/disk1/oracle/dbs/pdbseed/', '/disk1/
oracle/dbs/msappcon/');
```

- c. Open the new master application root in read/write mode:

```
ALTER PLUGGABLE DATABASE msappcon OPEN;
```

2. Install an application in the master application root.
  - a. Change container to the master application root:

```
ALTER SESSION SET CONTAINER=msappcon;
```

- b. Begin the application installation:

```
ALTER PLUGGABLE DATABASE APPLICATION sampleapp BEGIN INSTALL '1.0';
```

- c. Install the application.

For example, you can create database objects:

```
CREATE TABLE apptb SHARING=METADATA
(id          NUMBER(6),
 widget_name VARCHAR2(20));
```

**d.** End the application installation:

```
ALTER PLUGGABLE DATABASE APPLICATION sampleapp END INSTALL '1.0';
```

**3.** Create and synchronize one or more application PDBs in the master application root.

**a.** In SQL\*Plus, ensure that the current container is the master application root.

**b.** Create application PDBs in the master application root.

For example, create two application PDBs from the PDB seed:

```
CREATE PLUGGABLE DATABASE mspdb1 ADMIN USER mspdb1admin IDENTIFIED
BY password
STORAGE (MAXSIZE 2G)
DEFAULT TABLESPACE mspdb1tbs
DATAFILE '/disk1/oracle/dbs/mspdb1/mspdb101.dbf' SIZE 250M
AUTOEXTEND ON
FILE_NAME_CONVERT = ('/disk1/oracle/dbs/pdbseed/', '/disk1/
oracle/dbs/mspdb1/');
```

```
CREATE PLUGGABLE DATABASE mspdb2 ADMIN USER mspdb2admin IDENTIFIED
BY password
STORAGE (MAXSIZE 2G)
DEFAULT TABLESPACE mspdb2tbs
DATAFILE '/disk1/oracle/dbs/mspdb2/mspdb201.dbf' SIZE 250M
AUTOEXTEND ON
FILE_NAME_CONVERT = ('/disk1/oracle/dbs/pdbseed/', '/disk1/
oracle/dbs/mspdb2/');
```

**c.** Open both application PDBs:

```
ALTER PLUGGABLE DATABASE mspdb1 OPEN;
ALTER PLUGGABLE DATABASE mspdb2 OPEN;
```

**d.** Synchronize the application PDBs with the master application root:

```
ALTER SESSION SET CONTAINER=mspdb1;
ALTER PLUGGABLE DATABASE APPLICATION sampleapp SYNC;
```

```
ALTER SESSION SET CONTAINER=mspdb2;
ALTER PLUGGABLE DATABASE APPLICATION sampleapp SYNC;
```

**4.** Create the application container with the application root replica in the depdb CDB.

**a.** In SQL\*Plus, ensure that the current container is the depdb CDB root.

- b. Create the application container from the PDB seed with the following statement:

```
CREATE PLUGGABLE DATABASE depappcon
  AS APPLICATION CONTAINER
  ADMIN USER depappconadm IDENTIFIED BY password
  STORAGE (MAXSIZE 2G)
  DEFAULT TABLESPACE appcontbs
  DATAFILE '/disk2/oracle/dbs/depsappcon/depappcon01.dbf' SIZE
  250M AUTOEXTEND ON
  FILE_NAME_CONVERT = ('/disk2/oracle/dbs/pdbseed/', '/disk2/
  oracle/dbs/depappcon/');
```

 **Note:**

- If the port of the listener used by the application root replica is not 1521, then a `PORT` clause is required.
- If the host of the application root replica is different from the host of the master application root, then a `HOST` clause is required.

- c. Open the new application root replica in read/write mode:

```
ALTER PLUGGABLE DATABASE depappcon OPEN;
```

5. Create and synchronize the proxy PDB in the master application root.
- a. In SQL\*Plus, ensure that the current container is the master application root.
- b. Create a database link to the application root replica:

```
CREATE PUBLIC DATABASE LINK depappcon CONNECT TO depappconadm
  IDENTIFIED BY password USING 'depappcon';
```

- c. Create the proxy PDB:

```
CREATE PLUGGABLE DATABASE prxypdb AS PROXY FROM depappcon@depappcon
  FILE_NAME_CONVERT = ('/disk2/oracle/dbs/depsappcon/', '/disk1/
  oracle/dbs/prxypdb/');
```

- d. Open the proxy PDB:

```
ALTER PLUGGABLE DATABASE prxypdb OPEN;
```

- e. Synchronize the proxy PDB with the master application root:

```
ALTER SESSION SET CONTAINER=prxypdb;
ALTER PLUGGABLE DATABASE APPLICATION sampleapp SYNC;
```

6. Create and synchronize one or more application PDBs in the application root replica.

- a. Change container to the application root replica:

```
ALTER SESSION SET CONTAINER=depappcon;
```

- b. Create application PDBs in the application root replica.

For example, create two application PDBs from the PDB seed:

```
CREATE PLUGGABLE DATABASE deppdb1 ADMIN USER deppdb1admin
IDENTIFIED BY password
STORAGE (MAXSIZE 2G)
DEFAULT TABLESPACE deppdb1tbs
DATAFILE '/disk2/oracle/dbs/deppdb1/deppdb101.dbf' SIZE 250M
AUTOEXTEND ON
FILE_NAME_CONVERT = ('/disk2/oracle/dbs/pdbseed/', '/disk2/
oracle/dbs/deppdb1/');
```

```
CREATE PLUGGABLE DATABASE deppdb2 ADMIN USER deppdb2admin
IDENTIFIED BY password
STORAGE (MAXSIZE 2G)
DEFAULT TABLESPACE deppdb2tbs
DATAFILE '/disk2/oracle/dbs/deppdb2/deppdb201.dbf' SIZE 250M
AUTOEXTEND ON
FILE_NAME_CONVERT = ('/disk2/oracle/dbs/pdbseed/', '/disk2/
oracle/dbs/deppdb2/');
```

- c. Open both application PDBs:

```
ALTER PLUGGABLE DATABASE deppdb1 OPEN;
ALTER PLUGGABLE DATABASE deppdb2 OPEN;
```

- d. Synchronize the application PDBs with the master application root:

```
ALTER SESSION SET CONTAINER=deppdb1;
ALTER PLUGGABLE DATABASE APPLICATION sampleapp SYNC;
```

```
ALTER SESSION SET CONTAINER=deppdb2;
ALTER PLUGGABLE DATABASE APPLICATION sampleapp SYNC;
```

7. Check the structure of the `apptb` table in an application PDB in the application root replica.

- a. From the application root replica, switch containers to the `deppdb1` application PDB:

```
ALTER SESSION SET CONTAINER=deppdb1;
```

- b. Describe the `apptb` table:

```
desc apptb
```

Your output is similar to the following:

Name	Null?	Type
-----	-----	
ID		NUMBER(6)
WIDGET_NAME		VARCHAR2(20)

**8.** In the master application root, upgrade the application.

**a.** Change container to the master application root:

```
ALTER SESSION SET CONTAINER=msappcon;
```

**b.** Begin the application upgrade.

```
ALTER PLUGGABLE DATABASE APPLICATION sampleapp BEGIN UPGRADE '1.0'  
TO '1.1';
```

**c.** Modify the application.

For example, add a row to the `apptb` table:

```
ALTER TABLE apptb ADD (widget_type VARCHAR2(30));
```

**d.** End the application upgrade:

```
ALTER PLUGGABLE DATABASE APPLICATION sampleapp END UPGRADE TO '1.1';
```

**9.** Synchronize the proxy PDB with the master application root:

```
ALTER SESSION SET CONTAINER=prxypdb;  
ALTER PLUGGABLE DATABASE APPLICATION sampleapp SYNC;
```

**10.** Synchronize the application PDBs in the application root replica and check for the application upgrade.

**a.** Synchronize the application PDBs:

```
ALTER SESSION SET CONTAINER=deppdb1;  
ALTER PLUGGABLE DATABASE APPLICATION sampleapp SYNC;
```

```
ALTER SESSION SET CONTAINER=deppdb2;  
ALTER PLUGGABLE DATABASE APPLICATION sampleapp SYNC;
```

**b.** From the application root replica, switch containers to the `deppdb1` application PDB:

```
ALTER SESSION SET CONTAINER=deppdb1;
```

**c.** Describe the `apptb` table:

```
desc apptb
```

Your output is similar to the following:

Name	Null?	Type
-----	-----	
ID		NUMBER(6)
WIDGET_NAME		VARCHAR2(20)
WIDGET_TYPE		VARCHAR2(30)

Notice that the change in the application upgrade is reflected in the output because the `widget_type` column has been added to the `apptb` table.

### Related Topics

- [Creating Application Containers](#)  
You can use the `CREATE PLUGGABLE DATABASE` statement to create an application container in a CDB.
- [Creating a PDB as a Proxy PDB](#)  
You can create a PDB as a proxy PDB by referencing it in a remote CDB.
- [Managing Applications in an Application Container](#)  
You install, upgrade, or patch an application in an application container.
- [Synchronizing Applications in an Application PDB](#)  
Synchronizing an application updates the application in the application PDB to the latest version and patch in the application root.

## 17.3.8 Setting the Compatibility Version of an Application

The compatibility version of an application is the earliest version of the application possible for the application PDBs that belong to the application container.

The compatibility version is enforced when the compatibility version is set and when an application PDB is created. If there are application root clones that resulted from application upgrades, then all application root clones that correspond to versions earlier than the compatibility version are implicitly dropped.

You specify the compatibility version of an application by issuing one of the following SQL statements when the application root is the current container:

- ```
ALTER PLUGGABLE DATABASE APPLICATION application_name SET
COMPATIBILITY VERSION 'application_version_number';
```

  
*application\_name* is the name of the application, and *application\_version\_number* is the earliest compatible version.
- ```
ALTER PLUGGABLE DATABASE APPLICATION application_name SET
COMPATIBILITY VERSION CURRENT;
```

  
*application\_name* is the name of the application. The current version is the version of the application in the application root.

 **Note:**

You cannot plug in an application PDB that uses an application version earlier than the compatibility setting of the application container.

1. In SQL\*Plus, ensure that the current container is the application root.
2. Run an `ALTER PLUGGABLE DATABASE APPLICATION SET COMPATIBILITY VERSION` statement.

**Example 17-6 Setting the Compatibility Version to a Specific Version Number**

This example sets the compatibility version for an application named `salesapp` to version 4.2.

```
ALTER PLUGGABLE DATABASE APPLICATION salesapp SET COMPATIBILITY VERSION  
'4.2';
```

**Example 17-7 Setting the Compatibility Version to the Current Application Version**

This example sets the compatibility version for an application named `salesapp` to the current application version.

```
ALTER PLUGGABLE DATABASE APPLICATION salesapp SET COMPATIBILITY VERSION  
CURRENT;
```

 **See Also:**

["About Upgrading Applications in an Application Container"](#) for information about application root clones

## 17.3.9 Performing Bulk Inserts During Application Install, Upgrade, and Patch Operations

SQL\*Loader is the only supported utility for bulk inserts into tables during application install, upgrade, and patch operations. Only conventional path loads are supported for bulk inserts during application install, upgrade, and patch operations.

The correct SQL\*Loader module name must be specified between the `ALTER PLUGGABLE DATABASE APPLICATION BEGIN` and the `ALTER PLUGGABLE DATABASE APPLICATION END` statements. The module name is `SQL Loader Conventional Path Load`.

1. In SQL\*Plus, ensure that the current container is the application root.
2. Set the correct module by running the following procedure:

```
exec DBMS_APPLICATION_INFO.SET_MODULE('SQL Loader Conventional Path  
Load', '');
```



This module must remain set for the entire application install, upgrade, or patch operation.

3. Run the `ALTER PLUGGABLE DATABASE APPLICATION BEGIN` statement for beginning an application installation, upgrade, or patch.

For example, if you are performing the bulk insert as part of an application installation, then run the `ALTER PLUGGABLE DATABASE APPLICATION BEGIN INSTALL` statement in the following form:

```
ALTER PLUGGABLE DATABASE APPLICATION application_name BEGIN INSTALL  
'application_version_number';
```

4. Perform the conventional path load with SQL\*Loader.
5. Run the `ALTER PLUGGABLE DATABASE APPLICATION END` statement for ending an application installation, upgrade, or patch.

For example, if you are performing the bulk insert as part of an application installation, then run the `ALTER PLUGGABLE DATABASE APPLICATION END INSTALL` statement in the following form:

```
ALTER PLUGGABLE DATABASE APPLICATION application_name END INSTALL  
'application_version_number';
```

 **Note:**

Ensure that the *application\_name* and *application\_version\_number* match in the `ALTER PLUGGABLE DATABASE APPLICATION BEGIN INSTALL` statement and the `ALTER PLUGGABLE DATABASE APPLICATION END INSTALL` statement.

6. Synchronize all application PDBs that must include these application changes by issuing an `ALTER PLUGGABLE DATABASE APPLICATION` statement with the `SYNC` clause.

### Example 17-8 Performing a Conventional Path Load During an Application Installation

In this example, the conventional path load is performed in an application root.

1. In SQL\*Plus, switch to the application root.

```
ALTER SESSION SET CONTAINER=cdb1_aproot1;
```

2. Set the correct module.

```
exec DBMS_APPLICATION_INFO.SET_MODULE('SQL Loader Conventional Path  
Load', '');
```

3. Start the application installation.

```
ALTER PLUGGABLE DATABASE APPLICATION APP1 BEGIN INSTALL '1';
```

4. Use SQL\*Loader to perform the conventional path load.

```
host sqlldr u1/u1@cdbl_aproot1 control=my_bulk_load.ctl rows=3  
log=my_bulk_load.log
```

5. End the application installation.

```
ALTER PLUGGABLE DATABASE APPLICATION APP1 END INSTALL '1';
```



#### See Also:

*Oracle Database Utilities* for information about SQL\*Loader

## 17.3.10 Uninstalling Applications from an Application Container

You can uninstall an application in an application container.

This section contains the following topics:

- [About Uninstalling Applications from an Application Container](#)  
You issue `ALTER PLUGGABLE DATABASE APPLICATION` statements to uninstall an application from the application root.
- [Uninstalling an Application from an Application Container](#)  
To uninstall an application in from application container, run the `ALTER PLUGGABLE DATABASE APPLICATION BEGIN UNINSTALL` statement to begin the uninstallation and the `ALTER PLUGGABLE DATABASE APPLICATION END UNINSTALL` statement to end it. The application uninstalled from the application PDBs that synchronize with the application in the application root.

### 17.3.10.1 About Uninstalling Applications from an Application Container

You issue `ALTER PLUGGABLE DATABASE APPLICATION` statements to uninstall an application from the application root.

You uninstall the application from the application root only, and application PDBs that synchronize with the application uninstall the application automatically. The uninstall operation can be done with one or more of the following: scripts, SQL statements, and graphical user interface tools.

You must indicate the start of the uninstallation with an `ALTER PLUGGABLE DATABASE APPLICATION BEGIN UNINSTALL` statement and the end of the uninstallation with an `ALTER PLUGGABLE DATABASE APPLICATION END UNINSTALL` statement. Each uninstallation must be associated with an application name and version number, which are specified in the `ALTER PLUGGABLE DATABASE APPLICATION` statements.

Uninstalling an application does not remove the application from the data dictionary. It marks the application as `UNINSTALLED` so that upgrade, patch, and uninstall of the application is disallowed.

Destructive changes to application objects are allowed during application uninstallation. Applications running in an application PDB continue to function during uninstallation and after the application is uninstalled from the application root. The

application can continue to function in the application PDB because the `ALTER PLUGGABLE DATABASE APPLICATION BEGIN UNINSTALL` statement creates a clone of the application root called an application root clone. An application root clone serves as a metadata repository for old versions of application objects, so that application PDBs that have not been synchronized with latest version of the application can continue to function. Because the clone is created while the application PDB is open, local undo must be configured at the CDB level before an application can be uninstalled.

 **Note:**

An application upgrade also creates an application root clone.

 **See Also:**

- ["About Upgrading Applications in an Application Container"](#) for information about application root clones
- ["Running Oracle-Supplied SQL Scripts in a CDB"](#)

## 17.3.10.2 Uninstalling an Application from an Application Container

To uninstall an application in from application container, run the `ALTER PLUGGABLE DATABASE APPLICATION BEGIN UNINSTALL` statement to begin the uninstallation and the `ALTER PLUGGABLE DATABASE APPLICATION END UNINSTALL` statement to end it. The application uninstalled from the application PDBs that synchronize with the application in the application root.

The following prerequisites must be met:

- The CDB must be in local undo mode.
  - The current user must have the `ALTER PLUGGABLE DATABASE` system privilege, and the privilege must be commonly granted in the application root.
  - The application root must be in open read/write mode.
1. In SQL\*Plus, ensure that the current container is the application root.
  2. Run the `ALTER PLUGGABLE DATABASE APPLICATION BEGIN UNINSTALL` statement in the following form:

```
ALTER PLUGGABLE DATABASE APPLICATION application_name BEGIN UNINSTALL;
```

For example, run the following statement if the *application\_name* is `salesapp`:

```
ALTER PLUGGABLE DATABASE APPLICATION salesapp BEGIN UNINSTALL;
```

3. Uninstall the application using scripts, SQL statements, or graphical user interface tools.
4. Run the `ALTER PLUGGABLE DATABASE APPLICATION END UNINSTALL` statement in the following form:

```
ALTER PLUGGABLE DATABASE APPLICATION application_name END UNINSTALL;
```

For example, run the following statement if the *application\_name* is salesapp:

```
ALTER PLUGGABLE DATABASE APPLICATION salesapp END UNINSTALL;
```

 **Note:**

Ensure that the *application\_name* matches in the `ALTER PLUGGABLE DATABASE APPLICATION BEGIN UNINSTALL` statement and the `ALTER PLUGGABLE DATABASE APPLICATION END UNINSTALL` statement.

5. Synchronize all of the application PDBs that must uninstall the application by issuing an `ALTER PLUGGABLE DATABASE APPLICATION` statement with the `SYNC` clause.

 **See Also:**

- ["Accessing a Container in a CDB"](#)
- ["Synchronizing Applications in an Application PDB"](#)
- ["Setting the Undo Mode in a CDB Using ALTER DATABASE"](#)

## 17.4 Managing Application Common Objects

Application common objects are shared, user-created database objects in an application container. Application common objects are created in an application root.

This section contains the following topics:

- [About Application Common Objects](#)  
Application common objects are created in an application root and are shared with the application PDBs that belong to the application root.
- [Restrictions for Application Common Objects](#)  
Some restrictions apply to application common objects.
- [Creating Application Common Objects](#)  
You create an application common object in an application root either by ensuring that the `DEFAULT_SHARING` initialization parameter is set to the correct value or by including the `SHARING` clause in the `CREATE SQL` statement.
- [Issuing DML Statements on Application Common Objects](#)  
The rules are different for issuing DML statements on metadata-linked, data-linked, and extended data-linked application common objects.
- [Modifying Application Common Objects with DDL Statements](#)  
When you modify an application common object in an application root with certain DDL statements, you must modify the object between `ALTER PLUGGABLE DATABASE APPLICATION BEGIN` and `ALTER PLUGGABLE DATABASE APPLICATION END` statements, and application PDBs must synchronize with the application to apply the changes.

## 17.4.1 About Application Common Objects

Application common objects are created in an application root and are shared with the application PDBs that belong to the application root.

There are three types of application common object: metadata-linked, data-linked, and extended data-linked. The following types of database objects can be application common objects:

- Analytic views
- Attribute dimensions
- Directories
- External procedure libraries
- Hierarchies
- Java classes, resources, and sources
- Object tables, types, and views
- Sequences
- Packages, stored functions, and stored procedures
- Synonyms
- Tables (including global temporary tables)
- Triggers
- Views

This section contains the following topics:

- [Creation of Application Common Objects](#)  
Create application common objects by issuing a `CREATE` statement when the current container is the application root and specifying the `SHARING` clause.
- [About Metadata-Linked Application Common Objects](#)  
For metadata-linked application common objects, the metadata for the object is stored once in the application root.
- [About Extended Data-Linked Application Common Objects](#)  
For data-linked application common objects, both the metadata and the data for the object is stored once in the application root. A data link in each application PDB that belongs to the application root enables the application PDBs to share the metadata and data of the object.
- [About Extended Data-Linked Application Common Objects](#)  
For an extended data-linked object, each application PDB can create its own data while sharing the common data in the application root. Only data stored in the application root is common for all application PDBs.



### See Also:

["Application Common Objects"](#)

### 17.4.1.1 Creation of Application Common Objects

Create application common objects by issuing a `CREATE` statement when the current container is the application root and specifying the `SHARING` clause.

You can specify the sharing attribute by including the `SHARING` clause in the `CREATE` statement or by setting the `DEFAULT_SHARING` initialization parameter in the application root. When you set the `DEFAULT_SHARING` initialization parameter, the setting is the default sharing attribute for all database objects of a supported type created in the application root. However, when a `SHARING` clause is included in a `CREATE` statement, its setting overrides the setting for the `DEFAULT_SHARING` initialization parameter.

You can specify one of the following for the sharing attribute:

- `METADATA`: A metadata link shares the database object's metadata, but its data is unique to each container. These database objects are referred to as metadata-linked application common objects. This setting is the default.
- `DATA`: A data link shares the database object, and its data is the same for all containers in the application container. Its data is stored only in the application root. These database objects are referred to as data-linked application common objects.
- `EXTENDED DATA`: An extended data link shares the database object, and its data in the application root is the same for all containers in the application container. However, each application PDB in the application container can store data that is unique to the application PDB. For this type of database object, data is stored in the application root and, optionally, in each application PDB. These database objects are referred to as extended data-linked application common objects.
- `NONE`: The database object is not shared.

For most types of application common objects, the only valid settings for the `SHARING` clause are `METADATA` and `NONE`. The following types of application common objects allow additional settings for the `SHARING` clause:

- For tables (excluding object tables), the `SHARING` clause can be set to `METADATA`, `DATA`, `EXTENDED DATA`, or `NONE`. For object tables, only `METADATA` or `NONE` is valid.
- For views (excluding object views), the `SHARING` clause can be set to `METADATA`, `DATA`, `EXTENDED DATA`, or `NONE`. For object views, only `METADATA` or `NONE` is valid.
- For sequences, the `SHARING` clause can be set to `METADATA`, `DATA`, or `NONE`.

With a metadata-linked sequence, each application PDB has its own sequence. When the metadata-linked sequence is incremented using the `NEXTVAL` pseudocolumn in one application PDB, it does not affect the value of the sequence in the other application PDBs in the application container.

With a data-linked sequence, each application PDB shares the same sequence in the application root. When the metadata-linked sequence is incremented using the `NEXTVAL` pseudocolumn in one application PDB, all other application PDBs in the same application container also see the change.

Application common objects can be created or changed only as part of an application installation, upgrade, or patch. An application PDB applies changes to application common objects when it synchronizes with the application that made the changes. If an application PDB is closed when an application common object is created, dropped,

or modified, then the appropriate changes are applied in the application PDB when it is opened and synchronized with the application.

The names of application common objects must not conflict with those of local database objects in any of the application PDBs that belong to the application root or Oracle-supplied common objects in the CDB root. If a newly opened application PDB contains a local database object whose name conflicts with that of an application common object, then the application PDB is opened in `RESTRICTED` mode. In this case, you must resolve the naming conflict before the application PDB can be opened in normal mode.

### 17.4.1.2 About Metadata-Linked Application Common Objects

For metadata-linked application common objects, the metadata for the object is stored once in the application root.

A metadata link in each application PDB that belongs to the application root enables the application PDBs to share the metadata for the object, including the object name and structure. The data for the object is unique to each container, including the application root and each application PDB that belongs to the application root.

Data definition language (DDL) operations on a metadata-linked application common object can be run in the application root only as part of an application installation, upgrade, or patch. However, the data can be modified in an application PDB using normal data manipulation language (DML) operations.

For example, consider a company with several regional offices. The company wants the structure of the information about employees to be consistent, but each office has different employees. If this company has a human resources application in an application container, it can create a separate application PDB for each regional office and use a metadata-linked table to store employee information. The data structure of the table, such as the columns, is the same in the application PDB for each regional office, but the employee data is different.

Another example might involve a company that builds and maintains a sales application that is used by several different businesses. Each business uses the same sales application, but the data for each business is different. For example, each business has different customers and therefore different customer data. To ensure that each client uses the same data structure for its application, the company might create an application container with metadata-linked application common objects. Each business that uses the sales application has its own application PDB, and the data structure is the same in each application PDB, but the data is different.

### 17.4.1.3 About Extended Data-Linked Application Common Objects

For data-linked application common objects, both the metadata and the data for the object is stored once in the application root. A data link in each application PDB that belongs to the application root enables the application PDBs to share the metadata and data of the object.

DDL operations on a data-linked application common object can be run in the application root only as part of an application installation, upgrade, or patch. In addition, the data can be modified using normal DML operations only in the application root. The data cannot be modified in application PDBs.

For example, consider a company with several regional offices. The company wants the information about the products they sell, such as the product names and

descriptions, to be consistent at all of the regional offices. If this company has a sales application in an application container, then it can create a separate application PDB for each regional office and use a data-linked table to store product information. Each application PDB can query the product information, and the product information is consistent at each regional office.

Data-linked application common objects are also useful for data that is standard and does not change. For example, a table that stores the postal codes for a country might be a data-linked application common object in an application container. All of the application PDBs access the same postal code data in the application root.

 **Note:**

If the data-linked application common object is part of a configuration that synchronizes an application root replica with a proxy PDB, then DML operations on a data-linked object in the application root can be done outside of an application action, but the DML operation is not automatically propagated to the application root replication through the proxy PDB. If you want the DML operation to be propagated to the application root replica, then the DML operation on a data-linked object in the application root must be done within an application installation, upgrade, or patch.

#### 17.4.1.4 About Extended Data-Linked Application Common Objects

For an extended data-linked object, each application PDB can create its own data while sharing the common data in the application root. Only data stored in the application root is common for all application PDBs.

DDL operations on an extended data-linked application common object can be run in the application root only as part of an application installation, upgrade, or patch. However, the data can be modified in the application root or in an application PDB using normal DML operations.

For example, a sales application in an application container might support several application PDBs, and all of the application PDBs need the postal codes in the United States for shipping purposes. In this case the postal codes can be stored in the application root so that all of the application PDBs can access it. However, one application PDB also makes sales in Canada, and this application PDB requires the postal codes for the United States and Canada. This one application PDB can store the postal codes for Canada in an extended data-linked object in the application PDB instead of in the application root.



 **Note:**

- Tables and views are the only types of database objects that can be extended data-linked objects.
- If the extended data-linked application common object is part of a configuration that synchronizes an application root replica with a proxy PDB, then DML operations on an extended data-linked object in the application root can be done outside of an application action, but the DML operation is not automatically propagated to the application root replication through the proxy PDB. If you want the DML operation to be propagated to the application root replica, then the DML operation on an extended data-linked object in the application root must be done within an application installation, upgrade, or patch.

## 17.4.2 Restrictions for Application Common Objects

Some restrictions apply to application common objects.

Queries on application common objects can return data from a container that is not the current container. For example, when the current container is an application root, queries that include the `CONTAINERS` clause can return data from application PDBs for metadata-linked application common objects. Also, when the current container is an application PDB, queries on data-linked and extended data-linked application common objects return data that resides in the application root.

Columns of the following types return no data in queries that return data from a container other than the current container:

- The following user-defined types: object types, varrays, REFs, and nested tables
- The following Oracle-supplied types: `ANYTYPE`, `ANYDATASET`, URI types, `SDO_TOPO_GEOMETRY`, `SDO_GEORASTER`, and `Expression`

In addition, queries on object tables and object views return no data from containers other than the current container.

### Related Topics

- [Querying Application Common Objects Across Application PDBs](#)  
The `CONTAINERS` clause enables you to query application common objects across all PDBs in an application container. Queries from the application root display data in objects that exist in all open PDBs in the container.

## 17.4.3 Creating Application Common Objects

You create an application common object in an application root either by ensuring that the `DEFAULT_SHARING` initialization parameter is set to the correct value or by including the `SHARING` clause in the `CREATE SQL` statement.

You can create a metadata-linked object, an extended data-linked, or a data-linked object in an application root as part of an application installation, upgrade, or patch. An application PDB applies changes to application common objects when it synchronizes with the application in the application root.

1. In SQL\*Plus, ensure that the current container is the application root.  
The current user must have the privileges required to create the database object.
2. Run the `ALTER PLUGGABLE DATABASE APPLICATION BEGIN` statement for beginning an application installation, upgrade, or patch.

For example, if you are creating the application common object as part of an application installation, then run the `ALTER PLUGGABLE DATABASE APPLICATION BEGIN INSTALL` statement in the following form:

```
ALTER PLUGGABLE DATABASE APPLICATION application_name BEGIN INSTALL  
'application_version_number';
```

3. Create the application common object and specify its sharing attribute in one of the following ways:
  - Ensure that the `DEFAULT_SHARING` initialization parameter is set to the desired sharing attribute in the application root, and issue the `CREATE SQL` statement to create the database object.
  - Issue the `CREATE SQL` statement, and include the `SHARING` clause set to `METADATA`, `DATA`, or `EXTENDED DATA`.

When a `SHARING` clause is included in a SQL statement, it takes precedence over the value specified in the `DEFAULT_SHARING` initialization parameter. For example, if the `DEFAULT_SHARING` initialization parameter is set to `METADATA` in the application root, and a database object is created with `SHARING` set to `DATA`, then the database object is created as a data-linked database object.

 **Note:**

Once a database object is created, its sharing attribute cannot be changed.

4. Run the `ALTER PLUGGABLE DATABASE APPLICATION END` statement for ending an application installation, upgrade, or patch.

For example, if you are creating the application common object as part of an application installation, then run the `ALTER PLUGGABLE DATABASE APPLICATION END INSTALL` statement in the following form:

```
ALTER PLUGGABLE DATABASE APPLICATION application_name END INSTALL  
'application_version_number';
```

 **Note:**

Ensure that the *application\_name* and *application\_version\_number* match in the `ALTER PLUGGABLE DATABASE APPLICATION BEGIN INSTALL` statement and the `ALTER PLUGGABLE DATABASE APPLICATION END INSTALL` statement.

5. Synchronize all of the application PDBs that must apply these changes by issuing an `ALTER PLUGGABLE DATABASE APPLICATION` statement with the `SYNC` clause with the application PDB as the current container.

**Example 17-9 Setting the DEFAULT\_SHARING Initialization Parameter**

This example sets the `DEFAULT_SHARING` initialization parameter to `DATA` both in memory and in the `SPFILE`. When a database object that supports sharing is created in the application root, and no `SHARING` clause is included in the `CREATE SQL` statement, the database object uses the sharing attribute specified in the `DEFAULT_SHARING` initialization parameter.

```
ALTER SYSTEM SET DEFAULT_SHARING=DATA SCOPE=BOTH;
```

**Example 17-10 Creating a Metadata-Linked Object**

This example creates the `employees_md` metadata-linked table by including the `SHARING=METADATA` clause. The *application\_name* is `salesapp` and the *application\_version\_number* is `4.2`, and the object is created during application installation.

```
ALTER PLUGGABLE DATABASE APPLICATION salesapp BEGIN INSTALL '4.2';
CREATE TABLE employees_md SHARING=METADATA
  (employee_id    NUMBER(6),
   first_name     VARCHAR2(20),
   last_name      VARCHAR2(25) CONSTRAINT emp_last_name_nn_demo NOT
NULL,
   email         VARCHAR2(25) CONSTRAINT emp_email_nn_demo    NOT
NULL,
   phone_number  VARCHAR2(20),
   hire_date     DATE  DEFAULT SYSDATE CONSTRAINT
emp_hire_date_nn_demo NOT NULL,
   job_id        VARCHAR2(10) CONSTRAINT    emp_job_nn_demo  NOT NULL,
   salary        NUMBER(8,2)  CONSTRAINT    emp_salary_nn_demo NOT
NULL,
   commission_pct NUMBER(2,2),
   manager_id    NUMBER(6),
   department_id NUMBER(4),
   dn            VARCHAR2(300),
              CONSTRAINT emp_salary_min_demo CHECK (salary > 0),
              CONSTRAINT emp_email_uk_demo UNIQUE (email));
ALTER PLUGGABLE DATABASE APPLICATION salesapp END INSTALL '4.2';
```

**Example 17-11 Creating a Data-Linked Object**

This example creates the `product_descriptions_ob` data-linked table by including the `SHARING=DATA` clause. The *application\_name* is `salesapp` and the *application\_version\_number* is `4.2`, and the object is created during application installation.

```
ALTER PLUGGABLE DATABASE APPLICATION salesapp BEGIN INSTALL '4.2';
CREATE TABLE product_descriptions_ob SHARING=DATA
  (product_id      NUMBER(6),
   language_id     VARCHAR2(3),
   translated_name  NVARCHAR2(50)  CONSTRAINT translated_name_nn
NOT NULL,
   translated_description NVARCHAR2(2000) CONSTRAINT translated_desc_nn
```

```
NOT NULL);
ALTER PLUGGABLE DATABASE APPLICATION salesapp END INSTALL '4.2';
```

### Example 17-12 Creating an Extended Data-Linked Object

This example creates the `postalcodes` extended data-linked table by including the `EXTENDED` keyword and the `SHARING` clause. The `application_name` is `salesapp` and the `application_version_number` is 4.2, and the object is created during application installation.

```
ALTER PLUGGABLE DATABASE APPLICATION salesapp BEGIN INSTALL '4.2';
CREATE TABLE postalcodes SHARING=EXTENDED DATA
  (code          VARCHAR2(7),
   country_id    NUMBER,
   place_name    VARCHAR2(20));
ALTER PLUGGABLE DATABASE APPLICATION salesapp END INSTALL '4.2';
```

### Example 17-13 Creating an Object That Is Not Shared in an Application Root

This example creates the `departments_ns` table and specifies that it is not a shared common application object by including the `SHARING=NONE` clause. After creation, this database object can be accessed only in the application root.

```
CREATE TABLE departments_ns SHARING=NONE
  (department_id    NUMBER(4),
   department_name  VARCHAR2(30) CONSTRAINT dept_name_nn NOT NULL,
   manager_id       NUMBER(6),
   location_id      NUMBER(4),
   dn               VARCHAR2(300));
```

#### Note:

The `ALTER PLUGGABLE DATABASE APPLICATION BEGIN` and `END` statements are not required when you create an object that is not a shared common object. However, if you create an object that is not shared in between `ALTER PLUGGABLE DATABASE APPLICATION BEGIN` and `END` statements, then the object is created in application PDBs that synchronize with the application.

#### Related Topics

- [Managing Applications in an Application Container](#)  
You install, upgrade, or patch an application in an application container.
- [Synchronizing Applications in an Application PDB](#)  
Synchronizing an application updates the application in the application PDB to the latest version and patch in the application root.

## 17.4.4 Issuing DML Statements on Application Common Objects

The rules are different for issuing DML statements on metadata-linked, data-linked, and extended data-linked application DML common objects.

This section contains the following topics:

- [Issuing DML on Metadata-Linked Common Objects](#)  
You can issue DML on metadata-linked application objects as normal.
- [Issuing DML on Data-Linked Common Objects](#)  
For data-linked application objects, issue DML as normal in the application root. For extended data-linked application objects, issue DML as normal in the application root and in application PDBs.

#### Related Topics

- [Managing Applications in an Application Container](#)  
You install, upgrade, or patch an application in an application container.
- [Synchronizing Applications in an Application PDB](#)  
Synchronizing an application updates the application in the application PDB to the latest version and patch in the application root.
- [Synchronizing an Application Root Replica with a Proxy PDB](#)  
When application containers in different CDBs have the same application, their application roots can be kept synchronized by creating a master application root, a replica application root, and a proxy PDB.

### 17.4.4.1 Issuing DML on Metadata-Linked Common Objects

You can issue DML on metadata-linked application objects as normal.

For metadata-linked application common objects, the object definitions are the same in all application PDBs, but the data is different. Users and applications can issue DML statements on these objects in the same way as for ordinary database objects. The DML only affects the current container.

This section contains the following topics:

- [Querying Using the CONTAINERS Clause](#)  
For metadata-linked objects, the `CONTAINERS` clause enables you to query a table or view across all PDBs in an application container.
- [Setting the Default Container or DML](#)  
You can set the `CONTAINERS_DEFAULT` attribute on any metadata-linked object so that DML issued in the application root is wrapped in the `CONTAINERS` clause by default.

#### 17.4.4.1.1 Querying Using the CONTAINERS Clause

For metadata-linked objects, the `CONTAINERS` clause enables you to query a table or view across all PDBs in an application container.

For metadata-linked objects, the `CONTAINERS` clause is useful when DML is run in the application root. The query performs a `UNION ALL`, returning all rows from the object in the root and all open application PDBs (except those in `RESTRICTED` mode).

To query a subset of the PDBs, specify the `CON_ID` or `CON$NAME` in predicate. If the queried table or view does not already contain a `CON_ID` column, then the query adds a `CON_ID` column to the query result, which identifies the container whose data a given row represents.

#### Prerequisites

Note the following prerequisites:

- To query data in an application container, you must be a common user connected to the application root.
- The table or view must exist in the application root and all PDBs in the application container.
- The table or view must be in your own schema. It is not necessary to specify schema, but if you do, then you must specify your own schema.

**To query a metadata-linked object in an application container:**

1. Log in to the application root as an application common user.
2. Specify the `CONTAINERS` clause in a `SELECT` statement.

For example, the following statement counts the number of rows in the `sh.customers` table in the root and every application PDB (sample output included):

```
SELECT c.CON_ID, COUNT(*)
FROM   CONTAINERS(sh.customers) c
GROUP BY c.CON_ID
ORDER BY 1;
```

CON_ID	COUNT(*)
3	20002
6	426
8	7232

#### 17.4.4.1.2 Setting the Default Container or DML

You can set the `CONTAINERS_DEFAULT` attribute on any metadata-linked object so that DML issued in the application root is wrapped in the `CONTAINERS` clause by default.

Set `ENABLE CONTAINERS_DEFAULT` in either an `ALTER TABLE` or `ALTER VIEW` statement. The `CONTAINERS_DEFAULT` column in the `DBA_TABLES` and `DBA_VIEWS` views shows whether the database object is enabled for the `CONTAINERS` clause by default.

**To set the default container for DML involving a metadata-linked table or view:**

1. Log in to the application root as an application common user.
2. Issue an `ALTER TABLE` or `ALTER VIEW` statement with the `ENABLE CONTAINERS_DEFAULT` clause in the application root.

The following statement sets the default container for `sh.customers`:

```
ALTER TABLE sh.customers ENABLE CONTAINERS_DEFAULT;
```

After setting this attribute, queries and DML statements issued in the application root use the `CONTAINERS` clause by default for `sh.customers`.

## 17.4.4.2 Issuing DML on Data-Linked Common Objects

For data-linked application objects, issue DML as normal in the application root. For extended data-linked application objects, issue DML as normal in the application root and in application PDBs.

For data-linked application objects, DML in the application root affects the data accessible by all PDBs in the application container. You cannot issue DML on data-linked application objects in application PDBs.

For extended data-linked application objects, DML in the application root affects the data accessible by all PDBs in the application container. DML in an application PDB only affects data that is unique to the application PDB.

Consider an application root that has data-linked or extended data-linked objects. Also, assume that this root is the master for application root replicas synchronized with proxy PDBs. In this case, DML only synchronizes with the replicas when DML occurs during an application installation, upgrade, or patch. Specifically, DML must occur in the root between `ALTER PLUGGABLE DATABASE APPLICATION ... {BEGIN|END}` statements. Other DML applies only to the current root and is not synchronized with root replicas.

**To issue DML for an application common object that is not part of an application root replica configuration:**

1. Connect to the appropriate container in the application container as a user with the privileges required to issue DML statements on the database object.
2. Issue DML statements normally.

**To issue DML for a data-linked or extended data-linked object that is part of an application root replica configuration:**

1. In SQL\*Plus, ensure that the current container is the master application root in the application root replica in the configuration.

The current user must have the privileges required to issue the DML statements on the database object.

2. Run the `ALTER PLUGGABLE DATABASE APPLICATION ... BEGIN` statement for beginning an application installation, upgrade, or patch.

If you are modifying the application common object as part of an application upgrade, then issue the upgrade statement in the following form:

```
ALTER PLUGGABLE DATABASE APPLICATION application_name BEGIN UPGRADE
  'application_start_version_number' TO
  'application_end_version_number';
```

For example, run the following statement if the *application\_name* is `salesapp`, the *application\_start\_version\_number* is `4.2`, and the *application\_end\_version\_number* is `4.3`:

```
ALTER PLUGGABLE DATABASE APPLICATION salesapp BEGIN UPGRADE '4.2' TO
'4.3';
```

3. Issue the DML statements on the data-linked application common object.

4. Run the `ALTER PLUGGABLE DATABASE APPLICATION ... END` statement.

For example, if you are modifying the application common object as part of an application upgrade, then run the statement in the following form:

```
ALTER PLUGGABLE DATABASE APPLICATION application_name END UPGRADE  
  TO 'application_end_version_number';
```

For example, run the following statement if the *application\_name* is `salesapp`, the *application\_start\_version\_number* is 4.2, and the *application\_end\_version\_number* is 4.3:

```
ALTER PLUGGABLE DATABASE APPLICATION salesapp END UPGRADE TO '4.3';
```

 **Note:**

Ensure that the *application\_name* and *application\_end\_version\_number* match in the `ALTER PLUGGABLE DATABASE APPLICATION BEGIN UPGRADE` statement and `ALTER PLUGGABLE DATABASE APPLICATION END UPGRADE` statements.

5. To synchronize all application PDBs that must apply these changes, issue an `ALTER PLUGGABLE DATABASE APPLICATION` statement with the `SYNC` clause when the application PDB is the current container.

## 17.4.5 Modifying Application Common Objects with DDL Statements

When you modify an application common object in an application root with certain DDL statements, you must modify the object between `ALTER PLUGGABLE DATABASE APPLICATION BEGIN` and `ALTER PLUGGABLE DATABASE APPLICATION END` statements, and application PDBs must synchronize with the application to apply the changes.

You can alter a metadata-linked object or a data-linked object in an application root. You run an `ALTER`, `RENAME`, or `DROP` SQL statement on the database object to perform a DDL change.

1. In SQL\*Plus, ensure that the current container is the application root.

The current user must have the privileges required to make the planned changes to the database object.

2. Run the `ALTER PLUGGABLE DATABASE APPLICATION BEGIN` statement for beginning an application installation, upgrade, or patch.

For example, if you are modifying the application common object as part of an application upgrade, then run the `ALTER PLUGGABLE DATABASE APPLICATION BEGIN UPGRADE` statement in the following form:

```
ALTER PLUGGABLE DATABASE APPLICATION application_name BEGIN UPGRADE  
 'application_start_version_number' TO  
 'application_end_version_number';
```

For example, run the following statement if the *application\_name* is `salesapp`, the *application\_start\_version\_number* is 4.2, and the *application\_end\_version\_number* is 4.3:



```
ALTER PLUGGABLE DATABASE APPLICATION salesapp BEGIN UPGRADE '4.2' TO
'4.3';
```

3. Modify the application common object with the DDL statement.

For example, an `ALTER TABLE` statement might add a column to a table.

4. Run the `ALTER PLUGGABLE DATABASE APPLICATION END` statement for ending an application installation, upgrade, or patch.

For example, if you are modifying the application common object as part of an application upgrade, then run the `ALTER PLUGGABLE DATABASE APPLICATION END UPGRADE` statement in the following form:

```
ALTER PLUGGABLE DATABASE APPLICATION application_name END UPGRADE TO
'application_end_version_number';
```

For example, run the following statement if the *application\_name* is `salesapp` and the *application\_end\_version\_number* is `4.3`:

```
ALTER PLUGGABLE DATABASE APPLICATION salesapp END UPGRADE TO '4.3';
```

 **Note:**

Ensure that the *application\_name* and *application\_end\_version\_number* match in the `ALTER PLUGGABLE DATABASE APPLICATION BEGIN UPGRADE` statement and the `ALTER PLUGGABLE DATABASE APPLICATION END UPGRADE` statement.

5. Synchronize all of the application PDBs that must apply these changes by issuing an `ALTER PLUGGABLE DATABASE APPLICATION` statement with the `SYNC` clause with the application PDB as the current container.

#### Related Topics

- [Managing Applications in an Application Container](#)  
You install, upgrade, or patch an application in an application container.
- [Synchronizing Applications in an Application PDB](#)  
Synchronizing an application updates the application in the application PDB to the latest version and patch in the application root.

## 17.5 Issuing DML Statements on Containers in an Application Container

A DML statement issued in an application root can modify one or more containers in the application container. In addition, you can specify one or more default container targets for DML statements.

This section contains the following topics:

- [About Issuing DML Statements on Containers in an Application Container](#)  
DML statements can affect database objects in more than one container in an application container.

- [Specifying the Default Container for DML Statements in an Application Container](#)  
To specify the default container for DML statements in an application container, issue the `ALTER PLUGGABLE DATABASE` statement with the `CONTAINERS DEFAULT TARGET` clause.

## 17.5.1 About Issuing DML Statements on Containers in an Application Container

DML statements can affect database objects in more than one container in an application container.

In an application root, a single DML statement that includes the `CONTAINERS` clause can modify a table or view in one or more containers in the application container. To use the `CONTAINERS` clause, specify the table or view being modified in the `CONTAINERS` clause and the containers in the `WHERE` clause. A target container can be specified in an `INSERT VALUES` statement by specifying a value for `CON_ID` in the `VALUES` clause. Also, a target container can be specified in an `UPDATE` or `DELETE` statement by specifying a `CON_ID` predicate in the `WHERE` clause.

For example, the following DML statement updates the `sales.customers` table in the containers with a `CON_ID` of 7 or 8:

```
UPDATE CONTAINERS(sales.customers) ctab
  SET ctab.city_name='MIAMI'
  WHERE ctab.CON_ID IN(7,8) AND
  CUSTOMER_ID=3425;
```

The values specified for the `CON_ID` in the `WHERE` clause must be for containers in the current application container.

You can specify default target containers for DML operations. If a DML statement does not specify values for the `CON_ID` in the `WHERE` clause, then the target containers of the DML operation are those specified in the database property `CONTAINERS_DEFAULT_TARGET` in the application root. When issued in an application root, the following DML statement modifies the default target containers for the application container:

```
UPDATE CONTAINERS(sales.customers) ctab
  SET ctab.city_name='MIAMI'
  WHERE CUSTOMER_ID=3425;
```

By default, the default target containers in an application container include all of its application PDBs but not its application root or application seed. You can determine the default target containers for an application container by running the following query:

```
SELECT PROPERTY_VALUE FROM DATABASE_PROPERTIES WHERE
PROPERTY_NAME='CONTAINERS_DEFAULT_TARGET';
```

In addition, you can enable the `CONTAINERS_DEFAULT` attribute for a table or view in an application root. When this attribute is enabled, the `CONTAINERS` clause is used for queries and DML statements on the database object by default, and the `CONTAINERS`

clause does not need to be specified in the SQL statements. To enable the `CONTAINERS_DEFAULT` attribute for a table or view in an application root, run the an `ALTER TABLE` or `ALTER VIEW` statement with the `ENABLE CONTAINERS_DEFAULT` clause.

The following restrictions apply to the `CONTAINERS` clause:

- The `CONTAINERS DEFAULT TARGET` clause does not affect `SELECT` statements.
- `INSERT as SELECT` statements where the target of the `INSERT` is in `CONTAINERS()` is not supported.
- A multitable `INSERT` statement where the target of the `INSERT` is in `CONTAINERS()` is not supported.
- DML statements using the `CONTAINERS` clause require that the database listener is configured using `TCP` (instead of `IPC`) and that the `PORT` and `HOST` values are specified for each target PDB using the `PORT` and `HOST` clauses, respectively.

#### Related Topics

- [About Application Common Objects](#)  
Application common objects are created in an application root and are shared with the application PDBs that belong to the application root.

## 17.5.2 Specifying the Default Container for DML Statements in an Application Container

To specify the default container for DML statements in an application container, issue the `ALTER PLUGGABLE DATABASE` statement with the `CONTAINERS DEFAULT TARGET` clause.

When a DML statement is issued in an application root without specifying containers in the `WHERE` clause, the DML statement affects the default container for the application container. The default container can be any container in the application container, including the application root or an application PDB. Only one default container is allowed.

1. In SQL\*Plus, ensure that the current container is the application root.  
The current user must have the commonly granted `ALTER PLUGGABLE DATABASE` privilege.
2. Run the `ALTER PLUGGABLE DATABASE` statement with the `CONTAINERS DEFAULT TARGET` clause.

#### Example 17-14 Specifying the Default Container for DML Statements in an Application Container

This example specifies that `APDB1` is the default container for DML statements in the application container.

```
ALTER PLUGGABLE DATABASE CONTAINERS DEFAULT TARGET = (APDB1);
```

**Example 17-15 Clearing the Default Container**

This example clears the default container setting. When it is not set, the default container is the application root.

```
ALTER PLUGGABLE DATABASE CONTAINERS DEFAULT TARGET = NONE;
```

## 17.6 Partitioning by PDB with Container Maps

Container maps enable the partitioning of data at the application PDB level when the data is not physically partitioned at the table level.

This section contains the following topics:

- [About Container Maps](#)  
A **container map** is a database property that specifies a partitioned map table defined in an application root.
- [Creating a Container Map](#)  
Create a container map by creating a map object and setting the `CONTAINER_MAP` database property to the map object.

### 17.6.1 About Container Maps

A **container map** is a database property that specifies a partitioned map table defined in an application root.

Use a container map to partition the data in metadata-linked objects. Container maps partition data in application PDBs based on a commonly-used column.

For example, you might create a metadata-linked table named `countries_mlt` (with a column `cname`) that stores different data in each application PDB. The map table named `pdb_map_tbl` partitions by list on the `cname` column. The partitions `amer_pdb`, `euro_pdb`, and `asia_pdb` correspond to the names of the application PDBs.

A container map can define a logical partition key on a column for a common object. Because the container is resolved internally based on the container map, this mapping removes the requirement to define a query with a `CON_ID` predicate or use the `CONTAINERS` clause in the query.

Some types of row-based consolidation use a tenant ID with a single PDB that contains multiple tenants. Container maps are useful for migrating to a configuration that uses a different PDB for each tenant.

This section contains the following topics:

- [Map Objects](#)  
The **map object** is the partitioned table.
- [List-Partitioned Container Map: Example](#)  
This example uses a container map to route queries to PDBs that store data for a geographical region.
- [Range-Partitioned Container Map: Example](#)  
This example uses a container map to route queries to PDBs that store data for a particular department.

### 17.6.1.1 Map Objects

The **map object** is the partitioned table.

The names of the partitions in the map table match the names of the application PDBs in the application container. The metadata-linked object is not physically partitioned at the table level, but it can be queried using the partitioning strategy used by the container map.

To associate the map table with the metadata-linked table, specify the map table in `ALTER PLUGGABLE DATABASE ... CONTAINER_MAP` while connected to the application root. You can create no more than one container map in an application container. You cannot create container maps in the CDB root.

 **Note:**

- Data must be loaded into the PDB tables in a manner that is consistent with the partitions defined in map object.
- When there are changes to the application PDBs in an application container, the map object is not synchronized automatically to account for these changes. For example, an application PDB that is referenced in a map object can be unplugged, renamed, or dropped. The map object must be updated manually to account for such changes.

Starting in Oracle Database 18c, for a `CONTAINERS()` query to use a map, the partitioning column in the map table does not need to match a column in the metadata-linked table. Assume that the table `sh.sales` is enabled for the container map `pdb_map_tbl`, and `cname` is the partitioning column for the map table. Even though `sh.sales` does *not* include a `cname` column, the map table routes the following query to the appropriate PDB: `SELECT * FROM CONTAINERS(sh.sales) WHERE cname = 'US' ORDER BY time_id`.

### 17.6.1.2 List-Partitioned Container Map: Example

This example uses a container map to route queries to PDBs that store data for a geographical region.

The following illustration of an application root shows a map object, a metadata-linked table, and a query on the metadata-linked table. The query is executed in the appropriate application PDB.

Figure 17-3 Container Map

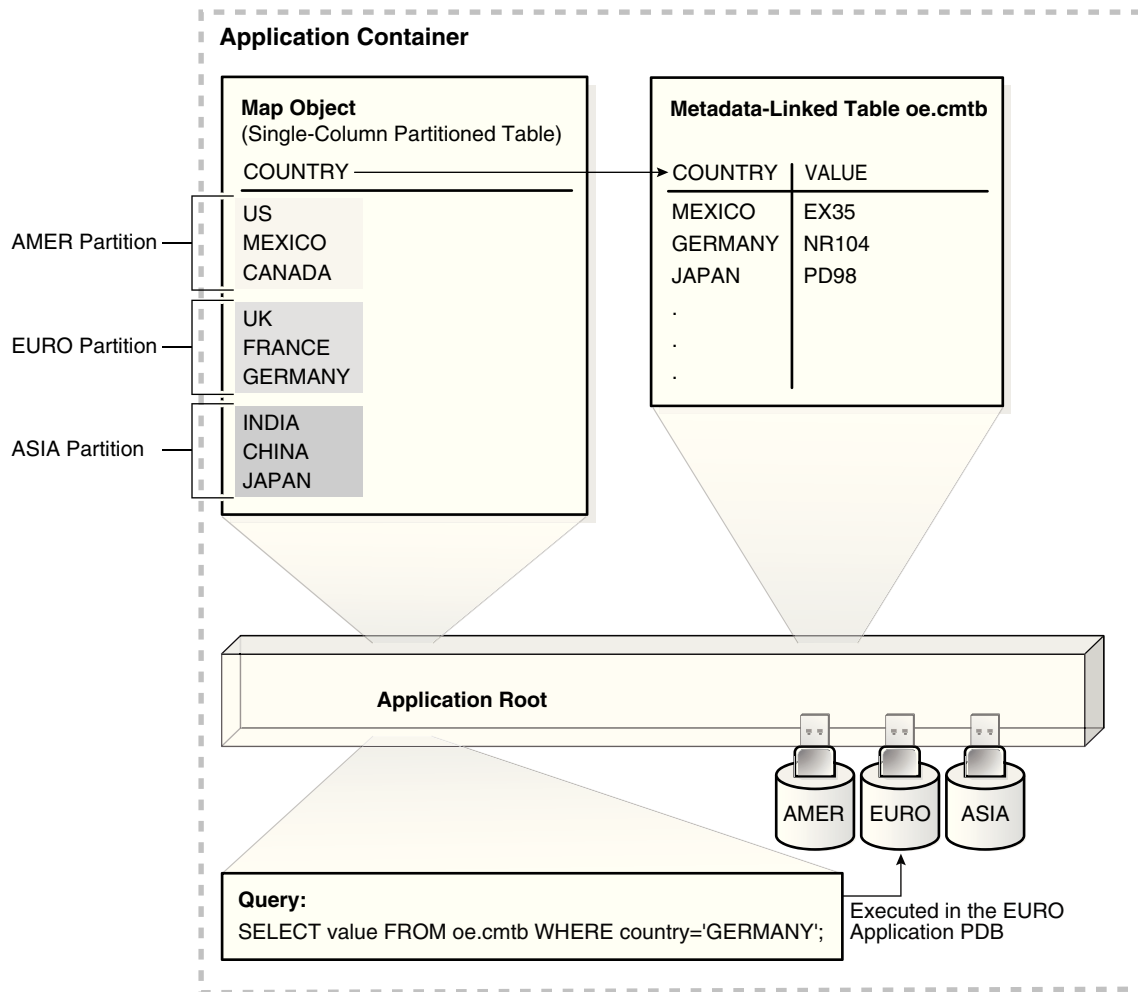

The illustration shows an application container with three application PDBs named **AMER**, **EURO**, and **ASIA**. The PDBs store data for the corresponding regions. A metadata-linked table named **oe.cmtb** stores information for an application. This table has a **COUNTRY** column. For this partitioning strategy, partition by list is used to create a map object that creates a partition for each region. The country value, which is **GERMANY** in the query shown in the illustration, determines the region, which is **EURO**.

 **See Also:**

"[Creating a Container Map](#)" for a detailed description of this example

### 17.6.1.3 Range-Partitioned Container Map: Example

This example uses a container map to route queries to PDBs that store data for a particular department.

Consider another example that uses a range-partitioned table for the map object. The following SQL statement creates the map object in the application root:

```
CREATE TABLE app_con_admin.conmap (  
    department_id NUMBER NOT NULL)  
PARTITION BY RANGE (department_id) (  
PARTITION apppdb1 VALUES LESS THAN (100),  
PARTITION apppdb2 VALUES LESS THAN (200),  
PARTITION apppdb3 VALUES LESS THAN (300));
```

This map object partitions data in the application PDBs apppdb1, apppdb2, and apppdb3 based on the commonly-used column `department_id`. The following SQL statement sets the `CONTAINER_MAP` database property to the `app_con_admin.conmap` table in the application root:

```
ALTER PLUGGABLE DATABASE SET CONTAINER_MAP='app_con_admin.conmap';
```

Queries that use container maps produce similar results to queries that use the `CONTAINERS` clause. For example, the following queries return similar results:

```
SELECT employee_id  
FROM   CONTAINERS(hr.employees)  
WHERE  department_id = 10  
AND    CON_ID IN (44);
```

```
SELECT employee_id  
FROM   hr.employees  
WHERE  department_id = 10;
```

As shown in the first query with the `CONTAINERS` clause, when the query only pertains to a single application PDB, the query must specify the container ID of this application PDB in the `WHERE` clause. This requirement might cause application changes.

The second query uses the container map, replacing the `CONTAINERS` clause. The second query does not specify the container because the container map directs the query to the correct application PDB. Queries that use container maps are generally more efficient than queries that use the `CONTAINERS` clause.

The container map must be created by a common user with `ALTER DATABASE` system privilege. Queries run against an object that is enabled for container map. Query privileges are determined by privileges granted on the object.

## 17.6.2 Creating a Container Map

Create a container map by creating a map object and setting the `CONTAINER_MAP` database property to the map object.

The map object is a partitioned table in which each partition name matches the name of an application PDB in an application container.

### Prerequisites

To create a container map, you must meet the following prerequisites:

- Before creating a container map, an application container with application PDBs must exist in the CDB.
- The application container must have at least one application installed in it.

**To create a container map:**

1. In SQL\*Plus, ensure that the current container is the application root.
2. Set the `CONTAINER_MAP` database property to the map object.

In the following statement, replace *map\_table\_schema* with the owner of the table, and replace *map\_table\_name* with the name of the table:

```
ALTER DATABASE SET CONTAINER_MAP = 'map_table_schema.map_table_name';
```

3. Start an application installation, upgrade, or patch.
4. If the metadata-linked table that will be used by the container map does not exist, then create it.
5. Enable the container map for the table to be queried by issuing an `ALTER TABLE ... ENABLE CONTAINER_MAP` statement.
6. Ensure that the table to be queried is enabled for the `CONTAINERS` clause by issuing an `ALTER TABLE ... ENABLE CONTAINERS_DEFAULT` statement.
7. End the application installation, upgrade, or patch started previously.

**Example 17-16 Creating and Using a Container Map**

This example creates a simple application that uses a container map. Assume that an application container has three application PDBs named `AMER`, `EURO`, and `ASIA`. The application PDBs store data for the different regions (America, Europe, and Asia, respectively). A metadata-linked table stores information for an application and has a `COUNTRY` column. For this partitioning strategy, partition by list is used to create a map object that creates a partition for each region, and the country value is used to determine the region.

1. In SQL\*Plus, ensure that the current container is the application root.
2. Create the map object.

```
CREATE TABLE salesadm.conmap (country VARCHAR2(30) NOT NULL)
PARTITION BY LIST (country) (
    PARTITION AMER VALUES ('US', 'MEXICO', 'CANADA'),
    PARTITION EURO VALUES ('UK', 'FRANCE', 'GERMANY'),
    PARTITION ASIA VALUES ('INDIA', 'CHINA', 'JAPAN')
);
```

3. Set the `CONTAINER_MAP` database property to the map object.

```
ALTER PLUGGABLE DATABASE SET CONTAINER_MAP='salesadm.conmap';
```

4. Begin an application installation.

```
ALTER PLUGGABLE DATABASE APPLICATION salesapp BEGIN INSTALL '1.0';
```



5. Create a metadata-linked table that will be queried using the container map.

```
CREATE TABLE oe.cmtb SHARING=METADATA (  
  value VARCHAR2(30),  
  country VARCHAR2(30));
```

6. Enable the container map for the table to be queried.

```
ALTER TABLE oe.cmtb ENABLE CONTAINER_MAP;
```

7. Ensure that the table to be queried is enabled for the CONTAINERS clause.

```
ALTER TABLE oe.cmtb ENABLE CONTAINERS_DEFAULT;
```

8. End the application installation.

```
ALTER PLUGGABLE DATABASE APPLICATION salesapp END INSTALL '1.0';
```

9. Switch session into each application PDB and synchronize it.

```
ALTER SESSION SET CONTAINER=amer;  
ALTER PLUGGABLE DATABASE APPLICATION salesapp SYNC;
```

```
ALTER SESSION SET CONTAINER=euro;  
ALTER PLUGGABLE DATABASE APPLICATION salesapp SYNC;
```

```
ALTER SESSION SET CONTAINER=asia;  
ALTER PLUGGABLE DATABASE APPLICATION salesapp SYNC;
```

10. Insert values into the oe.cmtb table in each application PDB based on the partitioning strategy.

```
ALTER SESSION SET CONTAINER=amer;  
INSERT INTO oe.cmtb VALUES ('AMER VALUE', 'US');  
INSERT INTO oe.cmtb VALUES ('AMER VALUE', 'MEXICO');  
INSERT INTO oe.cmtb VALUES ('AMER VALUE', 'CANADA');  
COMMIT;
```

```
ALTER SESSION SET CONTAINER=euro;  
INSERT INTO oe.cmtb VALUES ('EURO VALUE', 'UK');  
INSERT INTO oe.cmtb VALUES ('EURO VALUE', 'FRANCE');  
INSERT INTO oe.cmtb VALUES ('EURO VALUE', 'GERMANY');  
COMMIT;
```

```
ALTER SESSION SET CONTAINER=asia;  
INSERT INTO oe.cmtb VALUES ('ASIA VALUE', 'INDIA');  
INSERT INTO oe.cmtb VALUES ('ASIA VALUE', 'CHINA');  
INSERT INTO oe.cmtb VALUES ('ASIA VALUE', 'JAPAN');  
COMMIT;
```

11. Switch session into the application root and query the data using the container map.

```
ALTER SESSION SET CONTAINER=sales;  
  
SELECT value FROM oe.cmtb WHERE country='MEXICO';  
  
SELECT value FROM oe.cmtb WHERE country='GERMANY';  
  
SELECT value FROM oe.cmtb WHERE country='JAPAN';
```

The output for the first query should be `AMER VALUE`, the output for the second query should be `EURO VALUE`, and the output for the third query should be `ASIA VALUE`. These values illustrate that the container map is working correctly.

# 18

## Managing Security for a Multitenant Environment

You can manage common and local users and roles for a multitenant environment by using SQL\*Plus and Oracle Enterprise Manager.

This chapter contains the following topics:

- [Managing Security for a Multitenant Environment](#)  
You can manage common and local users and roles for a multitenant environment by using SQL\*Plus or SQL Developer.
- [Using Application Contexts in a Multitenant Environment](#)  
An application context stores user identification that can enable or prevent a user from accessing data in the database.
- [Using Oracle Virtual Private Database in a Multitenant Environment](#)  
Oracle Virtual Private Database (VPD) enables you to filter users who access data.
- [Using Transport Layer Security in a Multitenant Environment](#)  
Transport Layer Security (TLS) can be used in a multitenant environment for application containers.
- [Oracle Data Redaction in a Multitenant Environment](#)  
In a multitenant environment, Oracle Data Redaction policies apply only to the objects within the current pluggable database (PDB).
- [Auditing in a Multitenant Environment](#)  
Auditing tracks changes that users make in the multitenant container database (CDB).

### 18.1 Managing Security for a Multitenant Environment

You can manage common and local users and roles for a multitenant environment by using SQL\*Plus or SQL Developer.

This section contains the following topics:

- [Managing Commonly and Locally Granted Privileges](#)
- [Managing Common Roles and Local Roles](#)  
A common role is a role that is created in the root; a local role is created in a PDB.
- [Restricting Operations on PDBs Using PDB Lockdown Profiles](#)  
You can use PDB lockdown profiles in a multitenant environment to restrict sets of user operations in pluggable databases (PDBs).

#### 18.1.1 Managing Commonly and Locally Granted Privileges

- [How the Oracle Multitenant Option Affects Privileges](#)  
In a multitenant environment, all users, including common users, can exercise their privileges only within the current container.
- [About Commonly and Locally Granted Privileges](#)  
In a multitenant environment, both common users and local users can grant privileges to one another.
- [How Commonly Granted System Privileges Work](#)  
Users can exercise system privileges only within the PDB in which they were granted.
- [How Commonly Granted Object Privileges Work](#)  
Object privileges on common objects applies to the object as well as all associated links on this common object.
- [Granting or Revoking Privileges to Access a PDB](#)  
You can grant and revoke privileges for PDB access in a multitenant environment.
- [Example: Granting a Privilege in a Multitenant Environment](#)  
You can use the `GRANT` statement to grant privileges in a multitenant environment.
- [Enabling Common Users to View `CONTAINER\_DATA` Object Information](#)  
Common users can view information about `CONTAINER_DATA` objects in the root or for data in specific PDBs.

### 18.1.1.1 How the Oracle Multitenant Option Affects Privileges

In a multitenant environment, all users, including common users, can exercise their privileges only within the current container.

However, a user connected to the root can perform certain operations that affect other pluggable databases (PDBs). These operations include `ALTER PLUGGABLE DATABASE`, `CREATE USER`, `CREATE ROLE`, and `ALTER USER`. The common user must possess the commonly granted privileges that enable these operations. A common user connected to the root can see metadata pertaining to PDBs by way of the container data objects (for example, multitenant container database (CDB) views and `v$` views) in the root, provided that the common user has been granted privileges required to access these views and his `CONTAINER_DATA` attribute has been set to allow seeing data about various PDBs. The common user cannot query tables or views in a PDB.

Common users cannot exercise their privileges across other PDBs. They must first switch to the PDB that they want, and then exercise their privileges from there. To switch to a different container, the common user must have the `SET CONTAINER` privilege. The `SET CONTAINER` privilege must be granted either commonly or in the container to which the user is attempting to switch. Alternatively, the common user can start a new database session whose initial current container is the container this user wants, relying on the `CREATE SESSION` privilege in that PDB.

Be aware that commonly granted privileges may interfere with the security configured for individual PDBs. For example, suppose an application PDB database administrator wants to prevent any user in the PDB from modifying a particular application common object. A privilege (such as `UPDATE`) granted commonly to `PUBLIC` or to a common user or common role on the object would circumvent the PDB database administrator's intent.

#### Related Topics

- *Oracle Database Security Guide*

## 18.1.1.2 About Commonly and Locally Granted Privileges

In a multitenant environment, both common users and local users can grant privileges to one another.

Privileges by themselves are neither common nor local. How the privileges are applied depends on whether the privilege is granted commonly or granted locally.

For commonly granted privileges:

- A privilege that is granted commonly can be used in every existing and future container.
- Only common users can grant privileges commonly, and only if the grantee is common.
- A common user can grant privileges to another common user or to a common role.
- The grantor must be connected to the root and must specify `CONTAINER=ALL` in the `GRANT` statement.
- Both system and object privileges can be commonly granted. (Object privileges become actual only with regard to the specified object.)
- When a common user connects to or switches to a given container, this user's ability to perform various activities (such as creating a table) is controlled by privileges granted commonly as well as privileges granted locally in the given container.
- Do not grant privileges to `PUBLIC` commonly.

For locally granted privileges:

- A privilege granted locally can be used only in the container in which it was granted. When the privilege is granted in the root, it applies only to the root.
- Both common users and local users can grant privileges locally.
- A common user and a local user can grant privileges to other common or local roles.
- The grantor must be connected to the container and must specify `CONTAINER=CURRENT` in the `GRANT` statement.
- Any user can grant a privilege locally to any other user or role (both common and local) or to the `PUBLIC` role.

### Related Topics

- [Overview of Privilege and Role Grants in a CDB](#)  
Just as in a non-CDB, users in a CDB can grant and be granted roles and privileges. Roles and privileges in a CDB, however, are either locally or commonly granted.
- [How the PUBLIC Role Works in a Multitenant Environment](#)  
All privileges that Oracle grants to the `PUBLIC` role are granted locally.

## 18.1.1.3 How Commonly Granted System Privileges Work

Users can exercise system privileges only within the PDB in which they were granted.

For example, if a system privilege is locally granted to a common user A in a PDB B, user A can exercise that privilege only while connected to PDB B.

System privileges can apply in the root and in all existing and future PDBs if the following requirements are met:

- The system privilege grantor is a common user and the grantee is a common user, a common role, or the `PUBLIC` role. Do not commonly grant system privileges to the `PUBLIC` role, because this in effect makes the system privilege available to all users.
- The system privilege grantor possesses the `ADMIN OPTION` for the commonly granted privilege
- The `GRANT` statement must contain the `CONTAINER=ALL` clause.

The following example shows how to commonly grant a privilege to the common user `c##hr_admin`.

```
CONNECT SYSTEM
Enter password: password
Connected.

GRANT CREATE ANY TABLE TO c##hr_admin CONTAINER=ALL;
```

### Related Topics

- *Oracle Database Security Guide*

## 18.1.1.4 How Commonly Granted Object Privileges Work

Object privileges on common objects applies to the object as well as all associated links on this common object.

These links include all metadata links, data links (previously called object links), or extended data links that are associated with it in the root and in all PDBs belonging to the container (including future PDBs) if certain requirements are met.

These requirements are as follows:

- The object privilege grantor is a common user and the grantee is a common user, a common role, or the `PUBLIC` role.
- The object privilege grantor possesses the commonly granted `GRANT OPTION` for the privilege
- The `GRANT` statement contains the `CONTAINER=ALL` clause.

The following example shows how to grant an object privilege to the common user `c##hr_admin` so that he can select from the `DBA_PDBS` view in the CDB root or in any of the associated PDBs that he can access.

```
CONNECT SYSTEM
Enter password: password
Connected.

GRANT SELECT ON DBA_OBJECTS TO c##hr_admin
CONTAINER=ALL;
```

**Related Topics**

- [Oracle Database Security Guide](#)
- [Data Dictionary Architecture in a CDB](#)  
From the user and application perspective, the data dictionary in each container in a CDB is separate, as it would be in a non-CDB.
- [Namespaces in a CDB](#)  
In a CDB, the namespace for every object is scoped to its container.
- [How the PUBLIC Role Works in a Multitenant Environment](#)  
All privileges that Oracle grants to the `PUBLIC` role are granted locally.

### 18.1.1.5 Granting or Revoking Privileges to Access a PDB

You can grant and revoke privileges for PDB access in a multitenant environment.

**To grant a privilege in a multitenant environment:**

- Include the `CONTAINER` clause in the `GRANT` or `REVOKE` statement.

Setting `CONTAINER` to `ALL` applies the privilege to all existing and future containers; setting it to `CURRENT` applies the privilege to the local container only. Omitting the `CONTAINER` clause applies the privilege to the local container. If you issue the `GRANT` statement from the root and omit the `CONTAINER` clause, then the privilege is applied locally.

**Related Topics**

- [Oracle Database SQL Language Reference](#)

### 18.1.1.6 Example: Granting a Privilege in a Multitenant Environment

You can use the `GRANT` statement to grant privileges in a multitenant environment.

[Example 18-1](#) shows how to commonly grant the `CREATE TABLE` privilege to common user `c##hr_admin` so that this user can use this privilege in all existing and future containers.

**Example 18-1 Granting a Privilege in a Multitenant Environment**

```
CONNECT SYSTEM
Enter password: password
Connected.

GRANT CREATE TABLE TO c##hr_admin CONTAINER=ALL;
```

### 18.1.1.7 Enabling Common Users to View CONTAINER\_DATA Object Information

Common users can view information about `CONTAINER_DATA` objects in the root or for data in specific PDBs.

- [Viewing Data About the Root, CDB, and PDBs While Connected to the Root](#)  
You can restrict view information for the `X$` table and the `V$`, `GV$` and `CDB_*` views when common users perform queries.

- [Enabling Common Users to Query Data in Specific PDBs](#)  
You can enable common users to access data pertaining to specific PDBs by adjusting the users' CONTAINER\_DATA attribute.

### 18.1.1.7.1 Viewing Data About the Root, CDB, and PDBs While Connected to the Root

You can restrict view information for the X\$ table and the V\$, GV\$ and CDB\_\* views when common users perform queries.

Restricting this information is useful when you do not want to expose sensitive information about other PDBs. To enable this functionality, Oracle Database provides these tables and views as container data objects. You can find if a specific table or view is a container data object by querying the TABLE\_NAME, VIEW\_NAME, and CONTAINER\_DATA columns of the USER\_|DBA\_|ALL\_VIEWS|TABLES dictionary views.

**To find information about the default (user-level) and object-specific CONTAINER\_DATA attributes:**

1. In SQL\*Plus or SQL Developer, log in to the root.
2. Query the CDB\_CONTAINER\_DATA data dictionary view.

For example:

```
COLUMN USERNAME FORMAT A15
COLUMN DEFAULT_ATTR FORMAT A7
COLUMN OWNER FORMAT A15
COLUMN OBJECT_NAME FORMAT A15
COLUMN ALL_CONTAINERS FORMAT A3
COLUMN CONTAINER_NAME FORMAT A10
COLUMN CON_ID FORMAT A6
```

```
SELECT USERNAME, DEFAULT_ATTR, OWNER, OBJECT_NAME,
       ALL_CONTAINERS, CONTAINER_NAME, CON_ID
FROM   CDB_CONTAINER_DATA
ORDER BY OBJECT_NAME;
```

USERNAME CON_ID	DEFAULT_ATTR	OWNER	OBJECT_NAME	ALL_CONTAINERS
C##HR_ADMIN	N	SYS	V\$SESSION	N
CDB\$ROOT	1			
C##HR_ADMIN	N	SYS	V\$SESSION	N
SALESPDB	1			
C##HR_ADMIN	Y			N
HRPDB	1			
C##HR_ADMIN	Y			N
CDB\$ROOT	1			
DBSNMP	Y			
Y		1		
SYSTEM	Y			
Y		1		



## Related Topics

- [Container Data Objects in a CDB](#)  
A **container data object** is a table or view containing data pertaining to multiple containers or the whole CDB.
- [Oracle Database Reference](#)

### 18.1.1.7.2 Enabling Common Users to Query Data in Specific PDBs

You can enable common users to access data pertaining to specific PDBs by adjusting the users' `CONTAINER_DATA` attribute.

#### To enable common users to access data about specific PDBs:

- Issue the `ALTER USER` statement in the root.

#### Example 18-2 Setting the `CONTAINER_DATA` Attribute

This example shows how to issue the `ALTER USER` statement to enable the common user `c##hr_admin` to view information pertaining to the `CDB$ROOT`, `SALES_PDB`, and `HRPDB` containers in the `V$SESSION` view (assuming this user can query that view).

```
CONNECT SYSTEM
Enter password: password
Connected.
```

```
ALTER USER c##hr_admin
SET CONTAINER_DATA = (CDB$ROOT, SALESPDB, HRPDB)
FOR V$SESSION CONTAINER=CURRENT;
```

In this specification:

- `SET CONTAINER_DATA` lists containers, data pertaining to which can be accessed by the user.
- `FOR V$SESSION` specifies the `CONTAINER_DATA` dynamic view, which common user `c##hr_admin` will query.
- `CONTAINER = CURRENT` must be specified because when you are connected to the root, `CONTAINER=ALL` is the default for the `ALTER USER` statement, but modification of the `CONTAINER_DATA` attribute must be restricted to the root.

If you want to enable user `c##hr_admin` to view information that pertains to the `CDB$ROOT`, `SALES_PDB`, `HRPDB` containers in all `CONTAINER_DATA` objects that this user can access, then omit `FOR V$SESSION`. For example:

```
ALTER USER c##hr_admin
SET CONTAINER_DATA = (CDB$ROOT, SALESPDB, HRPDB)
CONTAINER=CURRENT;
```

## Related Topics

- [Oracle Database SQL Language Reference](#)

## 18.1.2 Managing Common Roles and Local Roles

A common role is a role that is created in the root; a local role is created in a PDB.

- [About Common Roles and Local Roles](#)
- [How Common Roles Work](#)  
Common roles are visible in the root and in every PDB of a container within which they are defined in a multitenant environment.
- [How the PUBLIC Role Works in a Multitenant Environment](#)  
All privileges that Oracle grants to the `PUBLIC` role are granted locally.
- [Privileges Required to Create, Modify, or Drop a Common Role](#)
- [Rules for Creating Common Roles](#)  
When you create a common role, you must follow special rules.
- [Creating a Common Role](#)  
You can use the `CREATE ROLE` statement to create a common role.
- [Rules for Creating Local Roles](#)  
To create a local role, you must follow special rules.
- [Creating a Local Role](#)  
You can use the `CREATE ROLE` statement to create a role.
- [Role Grants and Revokes for Common Users and Local Users](#)  
Role grants and revokes apply only to the scope of access of the common user or the local user.

### 18.1.2.1 About Common Roles and Local Roles

A local role exists in only one PDB and can only be used within this PDB. It does not have any commonly granted privileges.

Note the following:

- Common users can both create and grant common roles to other common and local users.
- You can grant a role (local or common) to a local user or role only locally.
- If you grant a common role locally, then the privileges of that common role apply only in the container where the role is granted.
- Local users cannot create common roles, but they can grant them to common and other local users.

#### Related Topics

- *Oracle Database Security Guide*

### 18.1.2.2 How Common Roles Work

Common roles are visible in the root and in every PDB of a container within which they are defined in a multitenant environment.

A privilege can be granted commonly to a common role if:

- The grantor is a common user.
- The grantor possesses the commonly granted `ADMIN OPTION` for the privilege that is being granted.
- The `GRANT` statement contains the `CONTAINER=ALL` clause.

If the common role contains locally granted privileges, then these privileges apply only within the PDB in which they were granted to the common role. A local role cannot be granted commonly.

### 18.1.2.3 How the PUBLIC Role Works in a Multitenant Environment

All privileges that Oracle grants to the `PUBLIC` role are granted locally.

This feature enables you to revoke privileges or roles that have been granted to the `PUBLIC` role individually in each PDB as needed. If you must grant any privileges to the `PUBLIC` role, then grant them locally. Never grant privileges to `PUBLIC` commonly.

#### Related Topics

- [About Commonly and Locally Granted Privileges](#)  
In a multitenant environment, both common users and local users can grant privileges to one another.

### 18.1.2.4 Privileges Required to Create, Modify, or Drop a Common Role

Common users can also create local roles, but these roles are available only in the PDB in which they were created.

### 18.1.2.5 Rules for Creating Common Roles

When you create a common role, you must follow special rules.

The rules are as follows:

### 18.1.2.6 Creating a Common Role

You can use the `CREATE ROLE` statement to create a common role.

1. Connect to the root of the CDB or the application container in which you want to create the common role.

For example:

```
CONNECT SYSTEM
Enter password: password
Connected.
```

2. Run the `CREATE ROLE` statement with the `CONTAINER` clause set to `ALL`.

For example:

```
CREATE ROLE c##sec_admin IDENTIFIED BY password CONTAINER=ALL;
```

### Related Topics

- [Oracle Database Security Guide](#)
- [Creating a Common Role in Enterprise Manager](#)  
Common roles can be used to assign common privileges to common users.

## 18.1.2.7 Rules for Creating Local Roles

To create a local role, you must follow special rules.

These rules are as follows:

- You must be connected to the PDB in which you want to create the role, and have the `CREATE ROLE` privilege.
- The name that you give the local role must not start with the value of the `COMMON_USER_PREFIX` parameter (which defaults to `C##`).
- You can include `CONTAINER=CURRENT` in the `CREATE ROLE` statement to specify the role as a local role. If you are connected to a PDB and omit this clause, then the `CONTAINER=CURRENT` clause is implied.
- You cannot have common roles and local roles with the same name. However, you can use the same name for local roles in different PDBs. To find the names of existing roles, query the `CDB_ROLES` and `DBA_ROLES` data dictionary views.

## 18.1.2.8 Creating a Local Role

You can use the `CREATE ROLE` statement to create a role.

1. Connect to the PDB in which you want to create the local role.

For example:

```
CONNECT SYSTEM@hrpdb
Enter password: password
Connected.
```

2. Run the `CREATE ROLE` statement with the `CONTAINER` clause set to `CURRENT`.

For example:

```
CREATE ROLE sec_admin CONTAINER=CURRENT;
```

### Related Topics

- [Oracle Database Security Guide](#)
- [Creating a Local Role in Enterprise Manager](#)  
A common role can be used to assign a local set of privileges to local users later.

## 18.1.2.9 Role Grants and Revokes for Common Users and Local Users

Role grants and revokes apply only to the scope of access of the common user or the local user.

Common users can grant and revoke common roles to and from other common users. A local user can grant a common role to any user in a PDB, including common users, but this grant applies only within the PDB.

The following example shows how to grant the common user `c##sec_admin` the `AUDIT_ADMIN` common role for use in all containers.

```
CONNECT SYSTEM
Enter password: password
Connected.

GRANT AUDIT_ADMIN TO c##sec_admin CONTAINER=ALL;
```

Similarly, the next example shows how local user `aud_admin` can grant the common user `c##sec_admin` the `AUDIT_ADMIN` common role for use within the `hrpdb` PDB.

```
CONNECT aud_admin@hrpdb
Enter password: password
Connected.

GRANT AUDIT_ADMIN TO c##sec_admin CONTAINER=CURRENT;
```

This example shows how a local user `aud_admin` can revoke a role from another user in a PDB. If you omit the `CONTAINER` clause, then `CURRENT` is implied.

```
CONNECT aud_admin@hrpdb
Enter password: password
Connected.

REVOKE sec_admin FROM psmith CONTAINER=CURRENT;
```

### Related Topics

- [Managing Common and Local Roles and Privileges in Enterprise Manager](#)  
In a multitenant environment, you can use Oracle Enterprise Manager to create, edit, drop, and revoke common and local roles.

## 18.1.3 Restricting Operations on PDBs Using PDB Lockdown Profiles

You can use PDB lockdown profiles in a multitenant environment to restrict sets of user operations in pluggable databases (PDBs).

This section contains the following topics:

- [About PDB Lockdown Profiles](#)  
A PDB lockdown profile is a named set of features that controls a group of operations.
- [Default PDB Lockdown Profiles](#)  
The default PDB lockdown profiles are `PRIVATE_DBAAS`, `PUBLIC_DBAAS`, and `SAAS`.
- [Creating a PDB Lockdown Profile](#)  
To create a PDB lockdown profile, you must have the `CREATE LOCKDOWN PROFILE` system privilege.

- [Enabling or Disabling a PDB Lockdown Profile](#)  
To enable or disable a PDB lockdown profile, use the `PDB_LOCKDOWN` initialization parameter
- [Dropping a PDB Lockdown Profile](#)  
To drop a PDB lockdown profile, you must have the `DROP LOCKDOWN PROFILE` system privilege and be logged into the CDB or application root.

### 18.1.3.1 About PDB Lockdown Profiles

A PDB lockdown profile is a named set of features that controls a group of operations.

In some cases, you can enable or disable operations individually. For example, a PDB lockdown profile can contain settings to disable specific clauses that come with the `ALTER SYSTEM` statement.

PDB lockdown profiles restrict user access to the functionality the features provided, similar to resource limits that are defined for users. As the name suggests, you use PDB lockdown profiles in a CDB, for an application container, or for a PDB or application PDB. You can create custom profiles to accommodate the requirements of your site. PDB profiles enable you to define custom security policies for an application. In addition, you can create a lockdown profile that is based on another profile, called a **base profile**. You can configure this profile to be dynamically updated when the base profile is modified, or configure it to be static (unchanging) when the base profile is updated. Lockdown profiles are designed for both Oracle Cloud and on-premises environments.

When identities are shared between PDBs, elevated privileges may exist. You can use lockdown profiles to prevent this elevation of privileges. Identities can be shared in the following situations:

- At the operating system level, when the database interacts with operating system resources such as files or processes
- At the network level, when the database communicates with other systems, and network identity is important
- Inside the database, as PDBs access or create common objects or they communicate across container boundaries using features such as database links

The features that use shared identifies and that benefit from PDB lockdown profiles are in the following categories:

- **Network access features.** These are operations that use the network to communicate outside the PDB. For example, the PL/SQL packages `UTL_TCP`, `UTL_HTTP`, `UTL_MAIL`, `UTL_SNMP`, `UTL_INADDR`, and `DBMS_DEBUG_JDWP` perform these kinds of operations. Currently, ACLs are used to control this kind of access to share network identity.
- **Common user or object access.** These are operations in which a local user in the PDB can proxy through common user accounts or access objects in a common schema. These kinds of operations include adding or replacing objects in a common schema, granting privileges to common objects, accessing common directory objects, granting the `INHERIT PRIVILEGES` role to a common user, and manipulating a user proxy to a common user.
- **Operating System access.** For example, you can restrict access to the `UTL_FILE` or `DBMS_FILE_TRANSFER` PL/SQL packages.

- **Connections.** For example, you can restrict common users from connecting to the PDB or you can restrict a local user who has the `SYSOPER` administrative privilege from connecting to a PDB that is open in restricted mode.

The general procedure for creating a PDB lockdown profile is to first create it in the CDB root or the application root using the `CREATE LOCKDOWN PROFILE` statement, and then use the `ALTER LOCKDOWN PROFILE` statement to add the restrictions.

To enable a PDB lockdown profile, you can use the `ALTER SYSTEM` statement to set the `PDB_LOCKDOWN` parameter. You can find information about existing PDB lockdown profiles by connecting to CDB or application root and querying the `DBA_LOCKDOWN_PROFILES` data dictionary view. A local user can find the contents of a PDB lockdown parameter by querying the `V$LOCKDOWN_RULES` dynamic data dictionary view.

### 18.1.3.2 Default PDB Lockdown Profiles

The default PDB lockdown profiles are `PRIVATE_DBAAS`, `PUBLIC_DBAAS`, and `SAAS`.

By default, these profiles are empty. They are designed to be a placeholder or template for you to configure, depending on your deployment requirements.

Detailed information about these profiles is as follows:

- `PRIVATE_DBAAS` incorporates restrictions that are suitable for private Cloud Database-as-a-Service (DBaaS) deployments. These restrictions are:
  - Must have the same database administrator for each PDB
  - Different users permitted to connect to the database
  - Different applications permitted

`PRIVATE_DBAAS` permits users to connect to the PDBs but prevents them from using Oracle Database administrative features.

- `SAAS` incorporates restrictions that are suitable for Software-as-a-Service (SaaS) deployments. These restrictions are:
  - Must have the same database administrator for each PDB
  - Different users permitted to connect to the database
  - Must use the same application

The `SAAS` lockdown profile is more restrictive than the `PRIVATE_DBAAS` profile. Users can be different, but the application code is the same; users are prevented from directly connecting and must connect only through the application; and users are not granted the ability to perform any administrative features.

- `PUBLIC_DBAAS` incorporates restrictions that are suitable for public Cloud Database-as-a-Service (DBaaS) deployments. The restrictions are as follows:
  - Different DBAs in each PDB
  - Different users
  - Different applications

The `PUBLIC_DBAAS` lockdown profile is the most restrictive of the lockdown profiles.

### 18.1.3.3 Creating a PDB Lockdown Profile

To create a PDB lockdown profile, you must have the `CREATE LOCKDOWN PROFILE` system privilege.

After you create the lockdown profile, you can add restrictions before enabling it.

1. Connect to the CDB root or the application root as a user who has the `CREATE LOCKDOWN PROFILE` system privilege.

For example, to connect to the CDB root:

```
CONNECT c##sec_admin
Enter password: password
```

2. Run the `CREATE LOCKDOWN PROFILE` statement to create the profile by using the following syntax:

```
CREATE LOCKDOWN PROFILE profile_name
[FROM static_base_profile | INCLUDING dynamic_base_profile];
```

In this specification:

- *profile\_name* is the name that you assign the lockdown profile. You can find existing names by querying the `PROFILE_NAMES` column of the `DBA_LOCKDOWN_PROFILES` data dictionary view.
- FROM *static\_base\_profile* creates a new lockdown profile by using the values from an existing profile. Any subsequent changes to the base profile will not affect the new profile.
- INCLUDING *dynamic\_base\_profile* also creates a new lockdown profile by using the values from an existing base profile, except that this new lockdown profile will inherit the `DISABLE STATEMENT` rules that comprise the base profile, as well as any subsequent changes to the base profile. If rules that are explicitly added to the new profile conflict with the rules in the base profile, then the rules in the base profile take precedence. For example, an `OPTION_VALUE` clause in the base profile takes precedence over the `OPTION_VALUE` clause in the new profile.

The following two PDB lockdown profile statements demonstrate how the inheritance works:

```
CREATE LOCKDOWN PROFILE hr_prof INCLUDING PRIVATE_DBAAS;
CREATE LOCKDOWN PROFILE hr_prof2 FROM hr_prof;
```

In the first statement, `hr_prof` inherits any changes made to the `PRIVATE_DBAAS` base profile. If a new statement is enabled for `PRIVATE_DBAAS`, then it is enabled for `hr_prof`. In the second statement, in contrast, when `hr_prof` changes, then `hr_prof2` does *not* change because it is independent of its base profile.

3. Run the `ALTER LOCKDOWN PROFILE` statement to provide restrictions for the profile.



For example:

```
ALTER LOCKDOWN PROFILE hr_prof DISABLE STATEMENT = ('ALTER SYSTEM');  
ALTER LOCKDOWN PROFILE hr_prof ENABLE STATEMENT = ('ALTER SYSTEM')  
clause = ('flush shared_pool');  
ALTER LOCKDOWN PROFILE hr_prof DISABLE FEATURE = ('XDB_PROTOCOLS');
```

In the preceding example:

- `DISABLE STATEMENT = ('ALTER SYSTEM')` disables the use of all `ALTER SYSTEM` statements for the PDB.
- `ENABLE STATEMENT = ('ALTER SYSTEM') clause = ('flush shared_pool')` enables only the use of the `FLUSH_SHARED_POOL` clause for `ALTER SYSTEM`.
- `DISABLE FEATURE = ('XDB_PROTOCOLS')` prohibits the use of the XDB protocols (FTP, HTTP, HTTPS) by this PDB

After you create a PDB lockdown profile, you are ready to enable it by using the `ALTER SYSTEM SET PDB_LOCKDOWN` SQL statement.

### Related Topics

- *Oracle Database SQL Language Reference*

## 18.1.3.4 Enabling or Disabling a PDB Lockdown Profile

To enable or disable a PDB lockdown profile, use the `PDB_LOCKDOWN` initialization parameter

You can use `ALTER SYSTEM SET PDB_LOCKDOWN` to enable a lockdown profile in any of the following contexts:

- CDB (affects all PDBs)
- Application root (affects all application PDBs in the container)
- Application PDB
- PDB

#### Note:

It is not necessary to restart the instance to enable the profile. When the `ALTER SYSTEM SET PDB_LOCKDOWN` statement completes, the profile rules take effect immediately.

When you set `PDB_LOCKDOWN` in the CDB root, every PDB and application root inherits this setting unless `PDB_LOCKDOWN` is set at the container level. To disable lockdown profiles, set `PDB_LOCKDOWN` to null. If you set this parameter to null in the CDB root, then lockdown profiles are disabled for all PDBs except those that explicitly set a profile within the PDB.

A CDB common user who has been commonly granted the `SYSDBA` administrative privilege or the `ALTER SYSTEM` system privilege can set `PDB_LOCKDOWN` only to a lockdown profile that was created in the CDB root. An application common user with

the application common SYSDBA administrative privilege or the ALTER SYSTEM system privilege can set PDB\_LOCKDOWN only to a lockdown profile created in an application root.

1. Log in to the desired container as a user who has the commonly granted ALTER SYSTEM or commonly granted SYSDBA privilege.

For example, to enable the profile for all PDBs, log in to the CDB root:

```
CONNECT c##sec_admin
Enter password: password
```

2. Run the ALTER SYSTEM SET PDB\_LOCKDOWN statement.

For example, the following statement enables the lockdown profile named hr\_prof for all PDBs:

```
ALTER SYSTEM SET PDB_LOCKDOWN = hr_prof;
```

The following statement resets the PDB\_LOCKDOWN parameter:

```
ALTER SYSTEM RESET PDB_LOCKDOWN;
```

This variation of the preceding statement includes the SCOPE clause::

```
ALTER SYSTEM RESET PDB_LOCKDOWN SCOPE = BOTH;
```

The following statement disables all lockdown profiles in the CDB except those that are explicitly set at the PDB level:

```
ALTER SYSTEM SET PDB_LOCKDOWN = '' SCOPE = BOTH;
```

To find the names of PDB lockdown profiles, query the PROFILE\_NAME column of the DBA\_LOCKDOWN\_PROFILES data dictionary view.

3. Optionally, review information about the profiles by querying DBA\_LOCKDOWN\_PROFILES.

For example, run the following query:

```
SET LINESIZE 150
COL PROFILE_NAME FORMAT a20
COL RULE FORMAT a20
COL CLAUSE FORMAT a25

SELECT PROFILE_NAME, RULE, CLAUSE, STATUS FROM CDB_LOCKDOWN_PROFILES;
```

Sample output appears below:

```
PROFILE_NAME          RULE                  CLAUSE
STATUS
-----
```

```

HR_PROF          XDB_PROTOCOLS
DISABLE
HR_PROF          ALTER SYSTEM
DISABLE
HR_PROF          ALTER SYSTEM          FLUSH SHARED_POOL
ENABLE
HR_PROF2
EMPTY
PRIVATE_DBAAS
EMPTY
PUBLIC_DBAAS
EMPTY
SAAS
EMPTY

```

### 18.1.3.5 Dropping a PDB Lockdown Profile

To drop a PDB lockdown profile, you must have the `DROP LOCKDOWN PROFILE` system privilege and be logged into the CDB or application root.

You can find the names of existing PDB lockdown profiles by querying the `DBA_LOCKDOWN_PROFILES` data dictionary view.

1. Connect to the CDB root or the application root as a user who has the `DROP LOCKDOWN PROFILE` system privilege.

For example, to connect to the CDB root:

```

CONNECT c##sec_admin
Enter password: password

```

2. Run the `DROP LOCKDOWN_PROFILE` statement.

For example:

```

DROP LOCKDOWN_PROFILE hr_prof2;

```

3. Optionally, review the current list of profiles by querying `DBA_LOCKDOWN_PROFILES`.

For example, run the following query:

```

SET LINESIZE 150
COL PROFILE_NAME FORMAT a20
COL RULE FORMAT a20
COL CLAUSE FORMAT a25

SELECT PROFILE_NAME, RULE, CLAUSE, STATUS FROM CDB_LOCKDOWN_PROFILES;

```

Sample output appears below:

```

PROFILE_NAME          RULE                  CLAUSE
STATUS
-----
HR_PROF              XDB_PROTOCOLS
DISABLE

```

```

HR_PROF          ALTER SYSTEM
DISABLE
HR_PROF          ALTER SYSTEM          FLUSH SHARED_POOL
ENABLE
PRIVATE_DBAAS
EMPTY
PUBLIC_DBAAS
EMPTY
SAAS
EMPTY

```

## 18.2 Using Application Contexts in a Multitenant Environment

An application context stores user identification that can enable or prevent a user from accessing data in the database.

- [What Is an Application Context?](#)  
An **application context** is a set of name-value pairs that Oracle Database stores in memory.
- [Application Contexts in a Multitenant Environment](#)  
Where you create an application in a multitenant environment determines where you must create the application context.

### 18.2.1 What Is an Application Context?

An **application context** is a set of name-value pairs that Oracle Database stores in memory.

The context has a label called a **namespace** (for example, `empno_ctx` for an application context that retrieves employee IDs). This context enables Oracle Database to find information about both database and nondatabase users during authentication.

Inside the context are the name-value pairs (an associative array): the name points to a location in memory that holds the value. An application can use the application context to access session information about a user, such as the user ID or other user-specific information, or a client ID, and then securely pass this data to the database.

You can then use this information to either permit or prevent the user from accessing data through the application. You can use application contexts to authenticate both database and non-database users.

#### Related Topics

- [Oracle Database Security Guide](#)

### 18.2.2 Application Contexts in a Multitenant Environment

Where you create an application in a multitenant environment determines where you must create the application context.

If an application is installed in the application root or CDB root, then it becomes accessible across the application container or system container and associated application PDBs. You will need to create a common application context in this root.

When you create a common application context for use with an application container, note the following:

- You can create application contexts in a multitenant environment by setting the `CONTAINER` clause in the `CREATE CONTEXT SQL` statement. For example, to create a common application context in the application root, you must execute `CREATE CONTEXT` with `CONTAINER` set to `ALL`. To create the application context in a PDB, set `CONTAINER` to `CURRENT`.
- You cannot use the same name for a local application context for a common application context. You can find the names of existing application contexts by running the following query:

```
SELECT OBJECT_NAME FROM DBA_OBJECTS WHERE OBJECT_TYPE = 'CONTEXT';
```

- The PL/SQL package that you create to manage a common application context must be a common PL/SQL package. That is, it must exist in the application root or CDB root. If you create the application context for a specific PDB, then you must store the associated PL/SQL package in that PDB.
- The name-value pairs that you set under a common session application context from an application container or a system container for a common application context are not accessible from other application containers or system containers when a common user accesses a different container.
- The name-value pairs that you set under a common global application context from an application container or a system container, are accessible only within the same container in the same user session.
- An application can retrieve the value of an application context whether it resides in the application root, the CDB root, or a PDB.
- During a plug-in operation of a PDB into a CDB or an application container, if the name of the common application context conflicts with a PDB's local application context, then the PDB must open in restricted mode. A database administrator would then need to correct the conflict before opening the PDB in normal mode.
- During an unplug operation, a common application context retains its common semantics, so that later on, if the PDB is plugged into another CDB where a common application context with the same name exists, it would continue to behave like a common object. If a PDB is plugged into an application container or a system container, where the same common application context does not exist, then it behaves like a local object.

To find if an application context is a local application context or an application common application context, query the `SCOPE` column of the `DBA_CONTEXT` or `ALL_CONTEXT` data dictionary view.

### Related Topics

- *Oracle Database Security Guide*

## 18.3 Using Oracle Virtual Private Database in a Multitenant Environment

Oracle Virtual Private Database (VPD) enables you to filter users who access data.

This section contains the following topics:

- [What Is Oracle Virtual Private Database?](#)  
Oracle Virtual Private Database (VPD) creates security policies to control database access at the row and column level.
- [Oracle Virtual Private Database in a Multitenant Environment](#)

### 18.3.1 What Is Oracle Virtual Private Database?

Oracle Virtual Private Database (VPD) creates security policies to control database access at the row and column level.



#### Note:

Oracle Database release 12c introduced Real Application Security (RAS) to supersede VPD. Oracle recommends that you use RAS for new projects that require row and column level access controls for their applications.

Essentially, Oracle Virtual Private Database adds a dynamic `WHERE` clause to a SQL statement that is issued against the table, view, or synonym to which an Oracle Virtual Private Database security policy was applied.

Oracle Virtual Private Database enforces security, to a fine level of granularity, directly on database tables, views, or synonyms. Because you attach security policies directly to these database objects, and the policies are automatically applied whenever a user accesses data, there is no way to bypass security.

When a user directly or indirectly accesses a table, view, or synonym that is protected with an Oracle Virtual Private Database policy, Oracle Database dynamically modifies the SQL statement of the user. This modification creates a `WHERE` condition (called a predicate) returned by a function implementing the security policy. Oracle Database modifies the statement dynamically, transparently to the user, using any condition that can be expressed in or returned by a function. You can apply Oracle Virtual Private Database policies to `SELECT`, `INSERT`, `UPDATE`, `INDEX`, and `DELETE` statements.

For example, suppose a user performs the following query:

```
SELECT * FROM OE.ORDERS;
```

The Oracle Virtual Private Database policy dynamically appends the statement with a `WHERE` clause. For example:

```
SELECT * FROM OE.ORDERS  
WHERE SALES_REP_ID = 159;
```

In this example, the user can only view orders by Sales Representative 159.

If you want to filter the user based on the session information of that user, such as the ID of the user, then you can create the `WHERE` clause to use an application context. For example:

```
SELECT * FROM OE.ORDERS
WHERE SALES_REP_ID = SYS_CONTEXT('USERENV', 'SESSION_USER');
```

 **Note:**

Oracle Virtual Private Database does not support filtering for DDLs, such as `TRUNCATE` or `ALTER TABLE` statements.

**Related Topics**

- *Oracle Database Real Application Security Administrator's and Developer's Guide*
- *Oracle Database Security Guide*

## 18.3.2 Oracle Virtual Private Database in a Multitenant Environment

The CDB restriction applies to shared context sensitive policies and views related to Virtual Private Database policies as well. You cannot create a Virtual Private Database policy for an entire multitenant environment.

**Related Topics**

- *Oracle Database Security Guide*

## 18.4 Using Transport Layer Security in a Multitenant Environment

Transport Layer Security (TLS) can be used in a multitenant environment for application containers.

If you want to use Transport Layer Security (TLS) in a multitenant environment for an application container, then you must ensure that each PDB is able to use its own wallet with its own certificates for TLS authentication.

- Because there is no individual `sqlnet.ora` file for each PDB, place the wallet in a subdirectory of the `wallet` directory where the name of the subdirectory is the GUID of the PDB that uses the wallet.

For example, suppose the `WALLET_LOCATION` parameter in `sqlnet.ora` is set as follows:

```
(SOURCE=(METHOD=FILE)(METHOD_DATA=
(DIRECTORY=/home/oracle/wallet)))
```

Place each PDB's wallet in the `/home/oracle/wallet` directory. You can find the existing PDBs and their GUIDs by querying the `DBA_PDBS` data dictionary view.

If the `WALLET_LOCATION` parameter is not specified, then you must place the PDB wallet in a subdirectory of the default wallet path where the name of the subdirectory is the GUID of the PDB. For example:

```
$ORACLE_BASE/admin/db_unique_name/wallet/PDB_GUID
```

Or if the `ORACLE_BASE` environment variable is not set, then you can use the Oracle home:

```
$ORACLE_HOME/admin/db_unique_name/wallet/PDB_GUID
```

These default locations correspond to the default that is used by Oracle Enterprise User Security to locate wallets for authentication to LDAP.

### Related Topics

- [Oracle Database Security Guide](#)

## 18.5 Oracle Data Redaction in a Multitenant Environment

In a multitenant environment, Oracle Data Redaction policies apply only to the objects within the current pluggable database (PDB).

You cannot create a Data Redaction policy for a multitenant container database (CDB). This is because the objects for which you create Data Redaction policies typically reside in a PDB. If you have the `SYSDBA` privilege, then you can list all the PDBs in a CDB by running the `SHOW PDBS` command.

As with the CDB root, you cannot create Data Redaction policies in an application root.

## 18.6 Auditing in a Multitenant Environment

Auditing tracks changes that users make in the multitenant container database (CDB).

This section contains the following topics:

- [About Auditing in a Multitenant Environment](#)  
You can use unified auditing in a multitenant environment.
- [Example: Auditing the DBA Role in a Multitenant Environment](#)  
The `CREATE AUDIT POLICY` statement can audit roles in a multitenant environment.
- [Unified Audit Policies or AUDIT Settings in a Multitenant Environment](#)  
In a multitenant environment, you can create unified audit policies for individual PDBs and in the root.
- [Fine-Grained Auditing in a Multitenant Environment](#)

### 18.6.1 About Auditing in a Multitenant Environment

You can use unified auditing in a multitenant environment.



You can apply audit settings to individual PDBs or to the CDB, depending on the type of policy. In a multitenant environment, each PDB, including the root, has own unified audit trail.

See the following sections for more information:

- **Unified audit policies created with the CREATE AUDIT POLICY and AUDIT statements:** You can create policies for both the root and individual PDBs.
- **Fine-grained audit policies:** You can create policies for individual PDBs only, not the root.
- **Purging the audit trail:** You can perform purge operations for both the root and individual PDBs.

#### Related Topics

- *Oracle Database Security Guide*

## 18.6.2 Example: Auditing the DBA Role in a Multitenant Environment

The `CREATE AUDIT POLICY` statement can audit roles in a multitenant environment.

The following example shows how to audit a predefined common role `DBA` in a multitenant environment.

### Example 18-3 Auditing the DBA Role in a Multitenant Environment

```
CREATE AUDIT POLICY role_dba_audit_pol
  ROLES DBA
  CONTAINER = ALL;

AUDIT POLICY role_dba_audit_pol;
```

## 18.6.3 Unified Audit Policies or AUDIT Settings in a Multitenant Environment

In a multitenant environment, you can create unified audit policies for individual PDBs and in the root.

- [page 18-24](#)
- [Traditional Auditing in a Multitenant Environment](#)  
In traditional auditing (not unified auditing), the `AUDIT` and `NOAUDIT` statements can audit statements and privileges in a multitenant environment.
- [Configuring a Local Unified Audit Policy or Common Unified Audit Policy](#)  
The `CONTAINER` clause is specific to multitenant environment use for the `CREATE AUDIT POLICY` statement.
- [Example: Local Unified Audit Policy](#)  
The `CREATE AUDIT POLICY` statement can create a local unified audit policy in either the root or a PDB.
- [Example: CDB Common Unified Audit Policy](#)  
The `CREATE AUDIT POLICY` statement can create a CDB common unified audit policy.

- [Example: Application Common Unified Audit Policy](#)  
For application container common unified audit policies, you can audit action options and system privilege options, and refer to common objects and roles.
- [How Local or Common Audit Policies or Settings Appear in the Audit Trail](#)  
You can query unified audit policy views from either the root or the PDB in which the action occurred.

### 18.6.3.1

This applies to both unified audit policies and policies that are created using the `AUDIT SQL` statement.

- **Local audit policy.** This type of policy can exist in either the root (CDB or application) or the PDB (CDB or application). A local audit policy that exists in the root can contain object audit options for both local and common objects. Both local and common users who have been granted the `AUDIT_ADMIN` role can enable local policies: local users from their PDBs and common users from the root or the PDB to which they have privileges. You can enable a local audit policy for both local and common users and roles.

You can create local audit policies for application local objects and application local roles, as well as system action options and system privilege options. You cannot enforce a local audit policy for a common user across all containers, nor can you enforce a common audit policy for a local user.

- **CDB common audit policy.** This type of policy is available to all PDBs in the multitenant environment. Only common users who have been granted the `AUDIT_ADMIN` role can create and maintain common audit policies. You can enable common audit policies only for common users. You must create common audit policies only in the root. This type of policy can contain object audit options of only common objects, and be enabled only for common users. You can enable a common audit policy for common users and roles only.

You cannot enforce a common audit policy for a local user across all containers.

The following table explains how audit policies apply in different multitenant environments.

### 18.6.3.2 Traditional Auditing in a Multitenant Environment

In traditional auditing (not unified auditing), the `AUDIT` and `NOAUDIT` statements can audit statements and privileges in a multitenant environment.

- `AUDIT DROP ANY TABLE BY SYSTEM BY ACCESS CONTAINER = CURRENT;`
- `AUDIT DROP ANY TABLE BY SYSTEM BY ACCESS CONTAINER = ALL;`

#### Related Topics

- *Oracle Database SQL Language Reference*

 **See Also:**

*Oracle Database SQL Language Reference* for more information about the traditional `AUDIT` and `NOAUDIT` SQL statements

### 18.6.3.3 Configuring a Local Unified Audit Policy or Common Unified Audit Policy

The `CONTAINER` clause is specific to multitenant environment use for the `CREATE AUDIT POLICY` statement.

To create a local or common unified audit policy in either the CDB environment or an application container environment, include the `CONTAINER` clause in the `CREATE AUDIT POLICY` statement.

- Use the following syntax to create a local or common unified audit policy:

```
CREATE AUDIT POLICY policy_name
  action1 [,action2 ]
  [CONTAINER = {CURRENT | ALL}];
```

In this specification:

- `CURRENT` sets the audit policy to be local to the current PDB.
- `ALL` makes the audit policy a common audit policy, that is, available to the entire multitenant environment.

For example, for a common unified audit policy:

```
CREATE AUDIT POLICY dict_updates
  ACTIONS UPDATE ON SYS.USER$,
  DELETE ON SYS.USER$,
  UPDATE ON SYS.LINK$,
  DELETE ON SYS.LINK$
  CONTAINER = ALL;
```

Note the following:

- You can set the `CONTAINER` clause for the `CREATE AUDIT POLICY` statement but not for `ALTER AUDIT POLICY` or `DROP AUDIT POLICY`. If you want to change the scope of an existing unified audit policy to use this setting, then you must drop and re-create the policy.
- For `AUDIT` statements, you can set the `CONTAINER` clause for audit settings only if you have an Oracle database that has not been migrated to the Release 12.x and later audit features. You cannot use the `CONTAINER` clause in an `AUDIT` statement that is used to enable a unified audit policy.
- If you are in a PDB, then you can only set the `CONTAINER` clause to `CURRENT`, not `ALL`. If you omit the setting while in the PDB, then the default is `CONTAINER = CURRENT`.

- If you are in the root, then you can set the `CONTAINER` clause to either `CURRENT` if you want the policy to apply to the root only, or to `ALL` if you want the policy to apply to the entire CDB. If you omit the `CONTAINER` clause, then default is `CONTAINER = CURRENT`.
- For objects:
  - Common audit policies can have common objects only and local audit policies can have both local objects and common objects.
  - You cannot set `CONTAINER` to `ALL` if the objects involved are local. They must be common objects.
- For privileges:
  - You can set the `CONTAINER` to `CURRENT` (or omit the `CONTAINER` clause) if the user accounts involved are a mixture of local and common accounts. This creates a local audit configuration that applies only to the current PDB.
  - You cannot set `CONTAINER` to `ALL` if the users involved are local users. They must be common users.
  - If you set `CONTAINER` to `ALL` and do not specify a user list (using the `BY` clause in the `AUDIT` statement), then the configuration applies to all common users in each PDB.

#### Related Topics

- [Managing Applications in an Application Container](#)  
You install, upgrade, or patch an application in an application container.

### 18.6.3.4 Example: Local Unified Audit Policy

The `CREATE AUDIT POLICY` statement can create a local unified audit policy in either the root or a PDB.

When you create a local unified audit policy in the root, it only applies to the root and not across the multitenant environment.

The following example shows a local unified audit policy that has been created by the common user `c##sec_admin` from a PDB and applied to common user `c##hr_admin`.

#### Example 18-4 Local Unified Audit Policy

```
CONNECT c##sec_admin@hrpdb
Enter password: password
Connected.

CREATE AUDIT POLICY table_privs
  PRIVILEGES CREATE ANY TABLE, DROP ANY TABLE
  CONTAINER = CURRENT;

AUDIT POLICY table_privs BY c##hr_admin;
```

### 18.6.3.5 Example: CDB Common Unified Audit Policy

The `CREATE AUDIT POLICY` statement can create a CDB common unified audit policy.

[Example 18-5](#) shows a common unified audit policy that has been created by the common user `c##sec_admin` from the root and applied to common user `c##hr_admin`.

#### Example 18-5 Common Unified Audit Policy

```
CONNECT c##sec_admin
Enter password: password
Connected.

CREATE AUDIT POLICY admin_pol
  ACTIONS CREATE TABLE, ALTER TABLE, DROP TABLE
  ROLES c##hr_mgr, c##hr_sup
  CONTAINER = ALL;

AUDIT POLICY admin_pol BY c##hr_admin;
```

### 18.6.3.6 Example: Application Common Unified Audit Policy

For application container common unified audit policies, you can audit action options and system privilege options, and refer to common objects and roles.

You can create the application common audit policy only from the application root, and enable the policy for both application common users and CDB common users.

The following example shows how to create a policy that audits the application common user `SYSTEM` for the application container `app_pdb`. The audit policy audits `SELECT` actions on the `SYSTEM.utils_tab` table and on `DROP TABLE` actions on any of the PDBs in the container database, including the CDB root. The policy also audits the use of the `SELECT ANY TABLE` system privilege across all containers.

#### Example 18-6 Application Common Unified Audit Policy

```
CONNECT c##sec_admin@app_pdb
Enter password: password
Connected.

CREATE AUDIT POLICY app_pdb_admin_pol
  ACTIONS SELECT ON hr_app_cdb.utils_tab, DROP TABLE
  PRIVILEGES SELECT ANY TABLE
  CONTAINER = ALL;

AUDIT POLICY app_pdb_admin_pol by SYSTEM, c##hr_admin;
```

In the preceding example, setting `CONTAINER` to `ALL` applies the policy only to all the relevant object accesses in the application root and on all the application PDBs that belong to the application root. It does not apply the policy outside this scope.

### 18.6.3.7 How Local or Common Audit Policies or Settings Appear in the Audit Trail

You can query unified audit policy views from either the root or the PDB in which the action occurred.

You can perform the following types of queries:

- **Audit records from all PDBs.** The audit trail reflects audited actions that have been performed in the PDBs. For example, if user `lbrown` in `PDB1` performs an action that has been audited by either a common or a local audit policy, then the audit trail will capture this action. The `DBID` column in the `UNIFIED_AUDIT_TRAIL` data dictionary view indicates the PDB in which the audited action takes place and to which the policy applies. If you want to see audit records from all PDBs, you should query the `CDB_UNIFIED_AUDIT_TRAIL` data dictionary view from the root.
- **Audit records from common audit policies.** This location is where the common audit policy results in an audit record. The audit record can be generated anywhere in the multitenant environment—the root or the PDBs, depending on where the action really occurred. For example, the common audit policy `fga_pol` audits the `EXECUTE` privilege on the `DBMS_FGA` PL/SQL package, and if this action occurs in `PDB1`, then the audit record is generated in `PDB1` and not in the root. Hence, the audit record can be seen in `PDB1`.

You can query the `UNIFIED_AUDIT_TRAIL` data dictionary view for the policy from either the root or a PDB if you include a `WHERE` clause for the policy name (for example, `WHERE UNIFIED_AUDIT_POLICIES = 'FGA_POL'`).

The following example shows how to find the results of a common unified audit policy:

```
CONNECT c##sec_admin
Enter password: password
Connected.

SELECT DBID, ACTION_NAME, OBJECT_SCHEMA, OBJECT_NAME FROM
CDB_UNIFIED_AUDIT_TRAIL WHERE DBUSERNAME = 'c##hr_admin';
46892-1
DBID          ACTION_NAME  OBJECT_SCHEMA  OBJECT_NAME
-----
653916017    UPDATE      HR              EMPLOYEES
653916018    UPDATE      HR              JOB_HISTORY
653916017    UPDATE      HR              JOBS
```

## 18.6.4 Fine-Grained Auditing in a Multitenant Environment

Note the following general rules about fine-grained audit policies in a multitenant environment:

- You cannot create fine-grained audit policies on `SYS` objects.
- When you create a fine-grained audit policy in the CDB root, the policy cannot be applied to all PDBs. It only applies to objects within the CDB root. (In other words, there is no such thing as a common fine-grained audit policy for the CDB root.) If you want to create a fine-grained audit policy to audit a common object's access in all the PDBs, then you must explicitly create that policy in each PDB and then enable it on the common objects that is accessible in the PDB.
- When you create a fine-grained audit policy in a PDB, it applies only to objects within the PDB.

### Related Topics

- *Oracle Database Security Guide*

# 19

## Monitoring CDBs and PDBs

You can view information about CDBs and PDBs using SQL\*Plus or SQL Developer.

This chapter contains the following topics:

- [About CDB and Container Information in Views](#)  
In a CDB, the metadata for data dictionary tables and view definitions is stored only in the root.
- [Determining Whether a Database Is a CDB](#)  
You can query the `CDB` column in the `V$DATABASE` view to determine whether a database is a CDB or a non-CDB. The `CDB` column returns `YES` if the current database is a CDB or `NO` if the current database is a non-CDB.
- [Viewing Information About the Containers in a CDB](#)  
The `V$CONTAINERS` view provides information about all containers in a CDB, including the root and all PDBs.
- [Viewing Information About PDBs](#)  
The `CDB_PDBS` view and `DBA_PDBS` view provide information about the PDBs associated with a CDB, including the status of each PDB.
- [Viewing the Open Mode of Each PDB](#)  
The `V$PDBS` view provides information about the PDBs associated with the current database instance.
- [Querying Container Data Objects](#)  
In the root, container data objects can show information about database objects (such as tables and users) contained in the root and in PDBs. Access to PDB information is controlled by the common user's `CONTAINER_DATA` attribute.
- [Querying Across Containers with the CONTAINERS Clause](#)  
The `CONTAINERS` clause enables you to query tables and views across all containers in a CDB. It also enables you to query application common objects across all containers in an application container.
- [Determining the Current Container ID or Name](#)  
You can determine your current container ID or container name in a CDB.
- [Listing the Modifiable Initialization Parameters in PDBs](#)  
In a CDB, some initialization parameters apply to the root and to all PDBs. When such an initialization parameter is changed, it affects the entire CDB. You can set other initialization parameters to different values in each container.
- [Viewing the History of PDBs](#)  
The `CDB_PDB_HISTORY` view shows the history of the PDBs in a CDB. It provides information about when and how each PDB was created and other information about each PDB's history.
- [Viewing Information About Applications in Application Containers](#)  
Several views provide information about the applications in application containers in a CDB.

## Related Topics

- [Tools for a Multitenant Environment](#)  
You can use various tools to configure and administer a multitenant environment.

# 19.1 About CDB and Container Information in Views

In a CDB, the metadata for data dictionary tables and view definitions is stored only in the root.

Each container, including each PDB, application root, and application PDB, has its own set of data dictionary tables and views for the objects contained in the container. Because each container can contain different data and schema objects, containers can display different metadata in data dictionary views, even when querying the same view in each container. For example, metadata about tables displayed in the `DBA_TABLES` view can be different in two different containers because the containers can contain different tables. An internal mechanism called a [metadata link](#) enables a container to access the metadata for these views in the root.

If a dictionary table stores information that pertains to the whole CDB, instead of for each container, then the metadata and the data displayed in a data dictionary view are stored in the root. For example, Automatic Workload Repository (AWR) data can be stored in the root, and this data is displayed in some data dictionary views, such as the `DBA_HIST_ACTIVE_SESS_HISTORY` view. An internal mechanism called a [data link](#) enables a container to access both the metadata and the data for these types of views in the root.

This section contains the following topics:

- [About Viewing Information When the Current Container Is Not the CDB Root](#)  
When the current container is a PDB, an application root, or an application PDB, the data dictionary views show metadata for the current container only.
- [About Viewing Information When the Current Container Is the CDB Root](#)  
When the current container is the CDB root, a common user can view data dictionary information for the CDB root and for PDBs, application roots, and application PDBs by querying container data objects.
- [Views for a CDB](#)  
You can query a set of views for information about a CDB and its PDBs.



### See Also:

["Data Dictionary Architecture in a CDB"](#) for more information about dictionary access in containers, metadata links, and data links

## 19.1.1 About Viewing Information When the Current Container Is Not the CDB Root

When the current container is a PDB, an application root, or an application PDB, the data dictionary views show metadata for the current container only.



To an application connected to a PDB, application root, or application PDB, the data dictionary appears as it would for a non-CDB. The data dictionary only shows metadata related to the current container. Also, in a container that is not the CDB root, `CDB_` views only show information about database objects visible through the corresponding `DBA_` view.

## 19.1.2 About Viewing Information When the Current Container Is the CDB Root

When the current container is the CDB root, a common user can view data dictionary information for the CDB root and for PDBs, application roots, and application PDBs by querying container data objects.

A container data object is a table or view that can contain data pertaining to the following:

- One or more containers
- The CDB as a whole
- One or more containers and the CDB as a whole

Container data objects include `V$`, `GV$`, `CDB_`, and some Automatic Workload Repository `DBA_HIST*` views. A common user's `CONTAINER_DATA` attribute determines which containers are visible in container data objects.

In a CDB, for every `DBA_` view, there is a corresponding `CDB_` view. All `CDB_` views are container data objects, but most `DBA_` views are not.

Each container data object contains a `CON_ID` column that identifies the container for each row returned. [Table 19-1](#) describes the meanings of the values in the `CON_ID` column.

**Table 19-1 CON\_ID Column in Container Data Objects**

Value in CON_ID Column	Description
0	The data pertains to the entire CDB
1	The data pertains to the CDB root
2	The data pertains to the PDB seed
3 - 4,098	The data pertains to a PDB, an application root, or an application PDB Each container has its own container ID.

The following views behave differently from other `[G]V$` views:

- `[G]V$SYSSTAT`
- `[G]V$SYS_TIME_MODEL`
- `[G]V$SYSTEM_EVENT`
- `[G]V$SYSTEM_WAIT_CLASS`

When queried from the CDB root, these views return instance-wide data, with 0 in the `CON_ID` column for each row returned. However, you can query equivalent views that behave the same as other container data objects. The following views can return

specific data for each container in a CDB: [G]V\$CON\_SYSSTAT, [G]V\$CON\_SYS\_TIME\_MODEL, [G]V\$CON\_SYSTEM\_EVENT, and [G]V\$CON\_SYSTEM\_WAIT\_CLASS.

 **Note:**

- When querying a container data object, the data returned depends on whether containers are open and on the privileges granted to the user running the query.
- In an Oracle Real Application Clusters (Oracle RAC) environment, the data returned by container data objects might vary based on the instance to which a session is connected.
- In a non-CDB, all CON\_ID columns in container data objects are 0 (zero).
- When a container is opened in restricted mode, it is ignored in queries on CDB\_views.

 **See Also:**

- ["About the Current Container"](#)
- ["Container Data Objects in a CDB"](#)
- *Oracle Database Security Guide* for detailed information about container data objects

### 19.1.3 Views for a CDB

You can query a set of views for information about a CDB and its PDBs.

[Table 19-2](#) describes data dictionary views that are useful for monitoring a CDB and its PDBs.

**Table 19-2 Views for a CDB**

View	Description	More Information
Container data objects, including: <ul style="list-style-type: none"> <li>• V\$ views</li> <li>• GV\$ views</li> <li>• CDB_views</li> <li>• DBA_HIST* views</li> </ul>	Container data objects can display information about multiple PDBs. Each container data object includes a CON_ID column to identify containers.  There is a CDB_view for each corresponding DBA_view.	<a href="#">"Querying Container Data Objects"</a> <i>Oracle Database Security Guide</i>
{CDB DBA}_PDBS	Displays information about the PDBs associated with the CDB, including the status of each PDB.	<a href="#">"Viewing Information About PDBs"</a> <i>Oracle Database Reference</i>

**Table 19-2 (Cont.) Views for a CDB**

View	Description	More Information
CDB_PROPERTIES	Displays the permanent properties of each container in a CDB.	<i>Oracle Database Reference</i>
{CDB DBA}_PDB_HISTORY	Displays the history of each PDB.	<i>Oracle Database Reference</i>
{CDB DBA}_CONTAINER_DATA	Displays information about the user-level and object-level CONTAINER_DATA attributes specified in the CDB.	<i>Oracle Database Reference</i>
{CDB DBA}_HIST_PDB_INSTANCE	Displays the PDBs and instances in the Workload Repository.	<i>Oracle Database Reference</i>
{CDB DBA}_PDB_SAVED_STATES	Displays information about the current saved PDB states in the CDB.	<i>Oracle Database Reference</i> <a href="#">"Preserving or Discarding the Open Mode of PDBs When the CDB Restarts"</a>
{CDB DBA}_APPLICATIONS	Describes all applications in an application container.	<a href="#">"Viewing Information About Applications"</a>
{CDB DBA}_APP_STATEMENTS	Describes all statements from application installation, upgrade, and patch operations in an application container.	<a href="#">"Viewing Information About Application Statements"</a>
{CDB DBA}_APP_PATCHES	Describes all application patches in an application container.	<a href="#">"Viewing Information About Application Patches"</a>
{CDB DBA}_APP_ERRORS	Describes all application error messages generated in an application container.	<a href="#">"Viewing Information About Application Errors"</a>
{CDB DBA}_CDB_RSRC_PLANS	Displays information about all the CDB resource plans.	<i>Oracle Database Reference</i> <a href="#">"Viewing CDB Resource Plans"</a>
{CDB DBA}_CDB_RSRC_PLAN_DIRECTIVES	Displays information about all the CDB resource plan directives.	<i>Oracle Database Reference</i> <a href="#">"Viewing CDB Resource Plan Directives"</a>
PDB_ALERTS	Contains descriptions of reasons for PDB alerts.	<i>Oracle Database Reference</i>
PDB_PLUG_IN_VIOLATIONS	Displays information about incompatibilities between a PDB and the CDB to which it belongs. This view is also used to display information generated by executing DBMS_PDB.CHECK_PLUG_COMPATIBILITY.	<i>Oracle Database Reference</i> <a href="#">"Plugging In an Unplugged PDB"</a>
{USER ALL DBA CDB}_OBJECTS	Displays information about database objects, and the SHARING column shows whether a database object is a metadata-linked object, a data-linked object, an extended data-linked object, or a standalone object that is not linked to another object.	<i>Oracle Database Reference</i>

**Table 19-2 (Cont.) Views for a CDB**

View	Description	More Information
{ALL DBA CDB}_SERVICES	Displays information about database services, and the PDB column shows the name of the PDB associated with each service.	<i>Oracle Database Reference</i>
{USER ALL DBA CDB}_VIEWS {USER ALL DBA CDB}_TABLES	The CONTAINER_DATA column shows whether the view or table is a container data object.	<i>Oracle Database Reference</i>
{USER ALL DBA CDB}_USERS	The COMMON column shows whether a user is a common user or a local user.	<i>Oracle Database Reference</i>
{USER ALL DBA CDB}_ROLES {USER ALL DBA CDB}_COL_PRIVS {USER ALL}_COL_PRIVS_MADE {USER ALL}_COL_PRIVS_RECD {USER ALL}_TAB_PRIVS_MADE {USER ALL}_TAB_PRIVS_RECD {USER DBA CDB}_SYS_PRIVS {USER DBA CDB}_ROLE_PRIVS ROLE_TAB_PRIVS ROLE_SYS_PRIVS	The COMMON column shows whether a role or privilege is commonly granted or locally granted.	<i>Oracle Database Reference</i>
{USER ALL DBA CDB}_ARGUMENTS {USER ALL DBA CDB}_CLUSTERS {USER ALL DBA CDB}_CONSTRAINTS {ALL DBA CDB}_DIRECTORIES {USER ALL DBA CDB}_IDENTIFIERS {USER ALL DBA CDB}_LIBRARIES {USER ALL DBA CDB}_PROCEDURES {USER ALL DBA CDB}_SOURCE {USER ALL DBA CDB}_SYNONYMS {USER ALL DBA CDB}_VIEWS	The ORIGIN_CON_ID column shows the ID of the container from which the row originates.	<i>Oracle Database Reference</i>
[G]V\$DATABASE	Displays information about the database from the control file. If the database is a CDB, then CDB-related information is included.	<a href="#">"Determining Whether a Database Is a CDB"</a> <i>Oracle Database Reference</i>
[G]V\$CONTAINERS	Displays information about the containers associated with the current CDB, including the root and all PDBs.	<a href="#">"Viewing Information About the Containers in a CDB"</a> <i>Oracle Database Reference</i>
[G]V\$PDBS	Displays information about the PDBs associated with the current CDB, including the open mode of each PDB.	<a href="#">"Viewing the Open Mode of Each PDB"</a> <i>Oracle Database Reference</i>

**Table 19-2 (Cont.) Views for a CDB**

View	Description	More Information
[G]V\$PDB_INCARNATION	Displays information about all PDB incarnations. Oracle creates a new PDB incarnation whenever a PDB is opened with the RESETLOGS option.	<i>Oracle Database Reference</i>
[G]V\$SYSTEM_PARAMETER [G]V\$PARAMETER	Displays information about initialization parameters, and the I\$PDB_MODIFIABLE column shows whether a parameter can be modified for a PDB.	"Listing the Modifiable Initialization Parameters in PDBs" <i>Oracle Database Reference</i>
V\$DIAG_ALERT_EXT [G]V\$DIAG_APP_TRACE_FILE [G]V\$DIAG_OPT_TRACE_RECORDS V\$DIAG_SESS_OPT_TRACE_RECORDS V\$DIAG_SESS_SQL_TRACE_RECORDS [G]V\$DIAG_SQL_TRACE_RECORDS [G]V\$DIAG_TRACE_FILE [G]V\$DIAG_TRACE_FILE_CONTENTS	Displays trace file and alert file data for the current container in a CDB.	<i>Oracle Database SQL Tuning Guide</i>
V\$DIAG_INCIDENT V\$DIAG_PROBLEM	Displays information about problems and incidents for the current container in a CDB.	<i>Oracle Database Reference</i>

## 19.2 Determining Whether a Database Is a CDB

You can query the CDB column in the V\$DATABASE view to determine whether a database is a CDB or a non-CDB. The CDB column returns YES if the current database is a CDB or NO if the current database is a non-CDB.

To determine whether a database is a CDB:

1. In SQL\*Plus, connect to the database as an administrative user.
2. Query the V\$DATABASE view.

### Example 19-1 Determining Whether a Database is a CDB

```
SELECT CDB FROM V$DATABASE;
```

Sample output:

```
CDB
---
YES
```

#### See Also:

*Oracle Database Reference*

## 19.3 Viewing Information About the Containers in a CDB

The `V$CONTAINERS` view provides information about all containers in a CDB, including the root and all PDBs.

To view this information, the query must be run by a common user whose current container is the root. When the current container is a PDB, this view only shows information about the current PDB.

To view information about the containers in a CDB:

1. In SQL\*Plus, ensure that the current container is the root.  
See "[About Container Access in a CDB](#)".
2. Query the `V$CONTAINERS` view.

### Example 19-2 Viewing Identifying Information About Each Container in a CDB

```
COLUMN NAME FORMAT A8
```

```
SELECT NAME, CON_ID, DBID, CON_UID, GUID FROM V$CONTAINERS ORDER BY CON_ID;
```

Sample output:

NAME	CON_ID	DBID	CON_UID	GUID
CDB\$ROOT	1	659189539	1	C091A6F89C7572A1E0436797E40AC78D
PDB\$SEED	2	4026479912	4026479912	C091AE9C00377591E0436797E40AC138
HRPDB	3	3718888687	3718888687	C091B6B3B53E7834E0436797E40A9040
SALESPDB	4	2228741407	2228741407	C091FA64EF8F0577E0436797E40ABE9F



#### See Also:

- "[About Configuring and Managing a Multitenant Environment](#)"
- "[About the Current Container](#)"
- "[Determining the Current Container ID or Name](#)"
- *Oracle Database Reference*

## 19.4 Viewing Information About PDBs

The `CDB_PDBS` view and `DBA_PDBS` view provide information about the PDBs associated with a CDB, including the status of each PDB.

To view this information, the query must be run by a common user whose current container is the root. When the current container is a PDB, all queries on these views return no results.

To view information about PDBs:

1. In SQL\*Plus, ensure that the current container is the root.  
See ["Accessing a Container in a CDB with SQL\\*Plus"](#).
2. Query the CDB\_PDBS or DBA\_PDBS view.

### Example 19-3 Viewing Container ID, Name, and Status of Each PDB

```
COLUMN PDB_NAME FORMAT A15

SELECT PDB_ID, PDB_NAME, STATUS FROM DBA_PDBS ORDER BY PDB_ID;
```

Sample output:

PDB_ID	PDB_NAME	STATUS
2	PDB\$SEED	NORMAL
3	HRPDB	NORMAL
4	SALESPDB	NORMAL



#### See Also:

["About the Current Container"](#)

## 19.5 Viewing the Open Mode of Each PDB

The V\$PDBS view provides information about the PDBs associated with the current database instance.

You can query this view to determine the open mode of each PDB. For each PDB that is open, this view can also show when the PDB was last opened. A common user can query this view when the current container is the root or a PDB. When the current container is a PDB, this view only shows information about the current PDB.

To view the open status of each PDB:

1. In SQL\*Plus, access a container.  
See ["Accessing a Container in a CDB with SQL\\*Plus"](#).
2. Query the V\$PDBS view.

### Example 19-4 Viewing the Name and Open Mode of Each PDB

```
COLUMN NAME FORMAT A15
COLUMN RESTRICTED FORMAT A10
COLUMN OPEN_TIME FORMAT A30

SELECT NAME, OPEN_MODE, RESTRICTED, OPEN_TIME FROM V$PDBS;
```

Sample output:

NAME	OPEN_MODE	RESTRICTED	OPEN_TIME
PDB\$SEED	READ ONLY	NO	21-MAY-12 12.19.54.465 PM
HRPDB	READ WRITE	NO	21-MAY-12 12.34.05.078 PM
SALESPDB	MOUNTED	NO	22-MAY-12 10.37.20.534 AM

 **See Also:**

- ["Modifying the Open Mode of PDBs with ALTER PLUGGABLE DATABASE"](#)
- ["Modifying the Open Mode of PDBs"](#)
- ["Modifying a PDB with the ALTER PLUGGABLE DATABASE Statement"](#)
- ["About the Current Container"](#)

## 19.6 Querying Container Data Objects

In the root, container data objects can show information about database objects (such as tables and users) contained in the root and in PDBs. Access to PDB information is controlled by the common user's `CONTAINER_DATA` attribute.

For example, `CDB_` views are container data objects. See ["About Viewing Information When the Current Container Is the CDB Root"](#) and *Oracle Database Security Guide* for more information about container data objects.

Each container data object contains a `CON_ID` column that shows the container ID of each PDB in the query results. You can view the PDB name for a container ID by querying the `DBA_PDBS` view.

To use container data objects to show information about multiple PDBs:

1. In SQL\*Plus, ensure that the current container is the root.  
See ["About Container Access in a CDB"](#).
2. Query the container data object to show the desired information.

 **Note:**

When a query contains a join of a container data object and a non-container data object, and the current container is the root, the query returns data for the entire CDB only (`CON_ID = 0`).

### Example 19-5 Showing the Tables Owned by Specific Schemas in Multiple PDBs

This example queries the `DBA_PDBS` view and the `CDB_TABLES` view from the root to show the tables owned by `hr` user and `oe` user in the PDBs associated with the CDB. This query returns only rows where the PDB has an ID greater than 2 (`p.PDB_ID > 2`) to avoid showing the users in the CDB root and PDB seed.

```
COLUMN PDB_NAME FORMAT A15
COLUMN OWNER FORMAT A15
COLUMN TABLE_NAME FORMAT A30

SELECT p.PDB_ID, p.PDB_NAME, t.OWNER, t.TABLE_NAME
```



```

FROM DBA_PDBS p, CDB_TABLES t
WHERE p.PDB_ID > 2 AND
      t.OWNER IN('HR','OE') AND
      p.PDB_ID = t.CON_ID
ORDER BY p.PDB_ID;

```

Sample output:

PDB_ID	PDB_NAME	OWNER	TABLE_NAME
3	HRPDB	HR	COUNTRIES
3	HRPDB	HR	JOB_HISTORY
3	HRPDB	HR	EMPLOYEES
3	HRPDB	HR	JOBS
3	HRPDB	HR	DEPARTMENTS
3	HRPDB	HR	LOCATIONS
3	HRPDB	HR	REGIONS
4	SALESPDB	OE	PRODUCT_INFORMATION
4	SALESPDB	OE	INVENTORIES
4	SALESPDB	OE	ORDERS
4	SALESPDB	OE	ORDER_ITEMS
4	SALESPDB	OE	WAREHOUSES
4	SALESPDB	OE	CUSTOMERS
4	SALESPDB	OE	SUBCATEGORY_REF_LIST_NESTEDTAB
4	SALESPDB	OE	PRODUCT_REF_LIST_NESTEDTAB
4	SALESPDB	OE	PROMOTIONS
4	SALESPDB	OE	PRODUCT_DESCRIPTIONS

This sample output shows the PDB `hrpdb` has tables in the `hr` schema and the PDB `salespdb` has tables in the `oe` schema.

### Example 19-6 Showing the Users in Multiple PDBs

This example queries the `DBA_PDBS` view and the `CDB_USERS` view from the root to show the users in each PDB. The query uses `p.PDB_ID > 2` to avoid showing the users in the CDB root and the PDB seed.

```

COLUMN PDB_NAME FORMAT A15
COLUMN USERNAME FORMAT A30

SELECT p.PDB_ID, p.PDB_NAME, u.USERNAME
FROM DBA_PDBS p, CDB_USERS u
WHERE p.PDB_ID > 2 AND
      p.PDB_ID = u.CON_ID
ORDER BY p.PDB_ID;

```

Sample output:

PDB_ID	PDB_NAME	USERNAME
.		
.		
.		
3	HRPDB	HR

```

3 HRPDB          OLAPSYS
3 HRPDB          MDSYS
3 HRPDB          ORDSYS
.
.
.
4 SALESPDB      OE
4 SALESPDB      CTXSYS
4 SALESPDB      MDSYS
4 SALESPDB      EXFSYS
4 SALESPDB      OLAPSYS
.
.
.

```

### Example 19-7 Showing the Data Files for Each PDB in a CDB

This example queries the `DBA_PDBS` and `CDB_DATA_FILES` views to show the name and location of each data file for all of the PDBs in a CDB, including the PDB seed.

```

COLUMN PDB_ID FORMAT 999
COLUMN PDB_NAME FORMAT A8
COLUMN FILE_ID FORMAT 9999
COLUMN TABLESPACE_NAME FORMAT A10
COLUMN FILE_NAME FORMAT A45

SELECT p.PDB_ID, p.PDB_NAME, d.FILE_ID, d.TABLESPACE_NAME, d.FILE_NAME
FROM DBA_PDBS p, CDB_DATA_FILES d
WHERE p.PDB_ID = d.CON_ID
ORDER BY p.PDB_ID;

```

Sample output:

```

PDB_ID PDB_NAME FILE_ID TABLESPACE FILE_NAME
-----
-----
-----
2 PDB$SEED      6 SYSAUX      /disk1/oracle/dbs/pdbseed/cdb1_ax.f
2 PDB$SEED      5 SYSTEM      /disk1/oracle/dbs/pdbseed/cdb1_db.f
3 HRPDB         9 SYSAUX      /disk1/oracle/dbs/hrpdb/hrpdb_ax.f
3 HRPDB         8 SYSTEM      /disk1/oracle/dbs/hrpdb/hrpdb_db.f
3 HRPDB        13 USER        /disk1/oracle/dbs/hrpdb/hrpdb_usr.dbf
4 SALESPDB     15 SYSTEM      /disk1/oracle/dbs/salespdb/salespdb_db.f
4 SALESPDB     16 SYSAUX      /disk1/oracle/dbs/salespdb/salespdb_ax.f
4 SALESPDB     18 USER        /disk1/oracle/dbs/salespdb/
salespdb_usr.dbf

```

### Example 19-8 Showing the Temp Files in a CDB

This example queries the `CDB_TEMP_FILES` view to show the name and location of each temp file in a CDB, as well as the tablespace that uses the temp file.

```

COLUMN CON_ID FORMAT 999
COLUMN FILE_ID FORMAT 9999
COLUMN TABLESPACE_NAME FORMAT A15

```

```

COLUMN FILE_NAME FORMAT A45

SELECT CON_ID, FILE_ID, TABLESPACE_NAME, FILE_NAME
FROM CDB_TEMP_FILES
ORDER BY CON_ID;

```

Sample output:

```

CON_ID FILE_ID TABLESPACE_NAME FILE_NAME
-----
1      1 TEMP          /disk1/oracle/dbs/t_tmp1.f
2      2 TEMP          /disk1/oracle/dbs/pdbseed/t_tmp1.f
3      3 TEMP          /disk1/oracle/dbs/hrpdb/t_hrpdb_tmp1.f
4      4 TEMP          /disk1/oracle/dbs/salespdb/t_salespdb_tmp1.f

```

### Example 19-9 Showing the Services Associated with PDBs

This example queries the `CDB_SERVICES` view to show the PDB name, network name, and container ID of each service associated with a PDB.

```

COLUMN NETWORK_NAME FORMAT A30
COLUMN PDB FORMAT A15
COLUMN CON_ID FORMAT 999

SELECT PDB, NETWORK_NAME, CON_ID FROM CDB_SERVICES
WHERE PDB IS NOT NULL AND
      CON_ID > 2
ORDER BY PDB;

```

Sample output:

```

PDB          NETWORK_NAME          CON_ID
-----
HRPDB        hrpdb.example.com    3
SALESPDB    salespdb.example.com  4

```

#### See Also:

- ["About the Current Container"](#)
- ["Container Data Objects in a CDB"](#)
- *Oracle Database Security Guide* for detailed information about container data objects
- *Oracle Database Reference*

## 19.7 Querying Across Containers with the CONTAINERS Clause

The `CONTAINERS` clause enables you to query tables and views across all containers in a CDB. It also enables you to query application common objects across all containers in an application container.

This section contains the following topics:

- [About Querying Across Containers with the CONTAINERS Clause](#)  
The `CONTAINERS` clause enables you to query across containers in a CDB.
- [Querying User-Created Tables and Views Across All Containers](#)  
The `CONTAINERS` clause enables you to query user-created tables and views across all containers. This clause enables queries from the CDB root to display data in tables or views that exist in all open PDBs in a CDB.
- [Querying Application Common Objects Across Application PDBs](#)  
The `CONTAINERS` clause enables you to query application common objects across all PDBs in an application container. Queries from the application root display data in objects that exist in all open PDBs in the container.

### 19.7.1 About Querying Across Containers with the CONTAINERS Clause

The `CONTAINERS` clause enables you to query across containers in a CDB.

The `CONTAINERS` clause enables you to query user-created tables and views across all containers in a CDB. This clause enables queries from the CDB root to display data in tables or views that exist in all open containers in a CDB.

The `CONTAINERS` clause also enables you to query application common objects, such as tables and views, across all application PDBs in an application container. This clause enables queries from the application root to display data in tables or views that exist in all open application PDBs in the application container.

The `CONTAINERS_PARALLEL_DEGREE` initialization parameter can control the degree of parallelism of a query involving the `CONTAINERS` clause. If the value of `CONTAINERS_PARALLEL_DEGREE` is lower than 65535 (the default), then the specified value is used.

When the `CONTAINERS_PARALLEL_DEGREE` initialization parameter is set to the default value (65535), queries that use the `CONTAINERS` clause are parallel by default. The default degree of parallelism is calculated with the following formula:

```
max(min(cpu_count, number_of_open_containers), #instances)
```

In addition, you can pass a `DEFAULT_PDB_HINT` hint in the `CONTAINERS` clause. The hint is passed in the query that is run in each container.

You can force the recursive SQL that results from a query that includes the `CONTAINERS` clause to be parallel by using the `DEFAULT_PDB_HINT` clause of a `CONTAINERS` hint or by using automatic degree of parallelism. However, parallel

statement queuing is not possible for recursive SQL that results from a query that includes the `CONTAINERS` clause.

Columns of the following types are removed if they exist in a table specified in a `CONTAINERS` clause:

- The following user-defined types: object types, varrays, REFs, and nested tables
- The following Oracle-supplied types: `ANYTYPE`, `ANYDATASET`, URI types, `SDO_TOPO_GEOMETRY`, `SDO_GEORASTER`, and `Expression`

 **Note:**

- When a container is opened in restricted mode, it is ignored by the `CONTAINERS` clause.
- When the `CONTAINERS` clause is used and an error is returned by a container, the query does not return results from the container that raised the error, and the error is not returned. For example, you cannot select a `BFILE` column from a remote table into a local variable. If a query that does this uses the `CONTAINERS` clause and includes local and remote containers, then the query returns results for the local containers, but not the remote containers, and no error is returned.

 **See Also:**

- ["About the Current Container"](#)
- *Oracle Database SQL Language Reference* for more information about the `CONTAINERS` clause and the `CONTAINERS` hint
- *Oracle Database Security Guide* for detailed information about container data objects
- *Oracle Database Reference* for more information about the `CONTAINERS_PARALLEL_DEGREE` initialization parameter
- *Oracle Database Data Warehousing Guide* for more information about automatic degree of parallelism and parallel statement queuing

## 19.7.2 Querying User-Created Tables and Views Across All Containers

The `CONTAINERS` clause enables you to query user-created tables and views across all containers. This clause enables queries from the CDB root to display data in tables or views that exist in all open PDBs in a CDB.

### Prerequisites

The tables and views, or synonyms of them, specified in the `CONTAINERS` clause must exist in the CDB root and in all other containers.

**To use the `CONTAINERS` clause to query tables and views across all containers:**

1. In SQL\*Plus, access a container.  
To view data in multiple containers, ensure that the current container is the CDB root.  
See "[About Container Access in a CDB](#)".
2. Run a query that includes the `CONTAINERS` clause.

### Example 19-10 Querying a Table Owned by a Common User Across All Containers

This example makes the following assumptions:

- An organization has several PDBs, and each PDB is for a different department in the organization.
- Each PDB has an `employees` table that tracks the employees in the department, but the table in each PDB contains different employees.
- The CDB root also has an empty `employees` table.
- The `employees` table in each container is owned by the same common user.

With the CDB root as the current container and the common user that owns the table as the current user, run the following query with the `CONTAINERS` clause to return all employees in the `employees` table in all PDBs:

```
SELECT * FROM CONTAINERS(employees);
```

### Example 19-11 Querying a Table Owned by Local Users Across All Containers

This example makes the following assumptions:

- An organization has several PDBs, and each PDB is for a different department in the organization.
- Each PDB has an `hr.employees` table that tracks the employees in the department, but the table in each PDB contains different employees.
- The CDB root also has an empty `employees` table owned by a common user.

To run a query that returns all employees in all PDBs, first connect to each PDB as a common user, and create a view with the following statement:

```
CREATE OR REPLACE VIEW employees AS SELECT * FROM hr.employees;
```

The common user that owns the view must be the same common user that owns the `employees` table in the CDB root. After you run this statement in each PDB, the common user has a view named `employees` in each PDB.

With the CDB root as the current container and the common user as the current user, run the following query with the `CONTAINERS` clause to return all employees in the `hr.employees` table in all PDBs:

```
SELECT * FROM CONTAINERS(employees);
```

You can also query the view in specific containers. For example, the following SQL statement queries the view in the containers with a `CON_ID` of 3 and 4:

```
SELECT * FROM CONTAINERS(employees) WHERE CON_ID IN(3,4);
```

#### Note:

You can also use the `CONTAINERS` clause to query Oracle-supplied tables and views. When running the query, ensure that the current user is the owner of the table or view, or create a view using the `CONTAINERS` clause and grant `SELECT` privilege on the view to the appropriate users.

#### See Also:

- ["About the Current Container"](#)
- ["Container Data Objects in a CDB"](#)
- *Oracle Database SQL Language Reference* for more information about the `CONTAINERS` clause
- *Oracle Database Security Guide* for detailed information about container data objects

## 19.7.3 Querying Application Common Objects Across Application PDBs

The `CONTAINERS` clause enables you to query application common objects across all PDBs in an application container. Queries from the application root display data in objects that exist in all open PDBs in the container.

The `CONTAINERS` clause is most useful for metadata-linked application common objects. With metadata-linked application common objects, the structure is the same in all containers in an application container, but the data is different. You can use the `CONTAINERS` clause to view the data in a metadata-linked application common object in multiple application PDBs. The benefits are similar for extended data-linked objects. The `CONTAINERS` clause uses parallel execution to execute the query across the distinct application PDBs hosted in the application root.

### To use the `CONTAINERS` clause to query tables and views across all application PDBs:

1. In SQL\*Plus, access the application root.  
See "[About Container Access in a CDB](#)".
2. Run a query that includes the `CONTAINERS` clause.

#### Note:

You can enable the `CONTAINERS_DEFAULT` attribute for a table or view in an application root. When this attribute is enabled, the `CONTAINERS` clause is used for queries and DML statements on the database object by default, and the `CONTAINERS` clause is not required in the SQL statements. To enable the `CONTAINERS_DEFAULT` attribute for a table or view in an application root, run the `ALTER TABLE` or `CREATE OR REPLACE VIEW` statement with the `ENABLE CONTAINERS_DEFAULT` clause.

### Example 19-12 Querying an Application Common Object Across All Application PDBs

This example makes the following assumptions:

- An organization has several application PDBs, and each application PDB is for a different department in the organization.
- Each application PDB has an `employees` table that tracks the employees in the department, but the table in each application PDB contains different employees.
- The application root also has an empty `employees` table.
- The `employees` table in each container is owned by the same common user.
- A company has multiple tenants that use an application in an application container, and each tenant has its own application PDB.
- The company uses metadata-linked application common objects to keep the structure of the data the same in all application PDBs, but the data is different in each application PDB.



- Each application PDB has a metadata-linked `sales.customers` table that stores information about each tenant's customers.

With the application root as the current container and the application common user that owns the table as the current user, run the following query with the `CONTAINERS` clause to return all customers in the `sales.customers` table in all application PDBs:

```
SELECT * FROM CONTAINERS(sales.customers);
```

#### See Also:

- ["About Application Common Objects"](#)
- ["About the Current Container"](#)
- *Oracle Database SQL Language Reference* for more information about the `CONTAINERS` clause
- *Oracle Database Security Guide* for detailed information about container data objects

## 19.8 Determining the Current Container ID or Name

You can determine your current container ID or container name in a CDB.

To determine the current container ID:

- Run the following SQL\*Plus command:

```
SHOW CON_ID
```

To determine the current container name:

- Run the following SQL\*Plus command:

```
SHOW CON_NAME
```

In addition, you can use the functions listed in [Table 19-3](#) to determine the container ID of a container.

**Table 19-3 Functions That Return the Container ID of a Container**

Function	Description
<code>CON_NAME_TO_ID('container_name')</code>	Returns the container ID based on the container's name.
<code>CON_DBID_TO_ID(container_dbid)</code>	Returns the container ID based on the container's DBID.
<code>CON_UID_TO_ID(container_uid)</code>	Returns the container ID based on the container's unique identifier (UID).
<code>CON_GUID_TO_ID(container_guid)</code>	Returns the container ID based on the container's globally unique identifier (GUID).

The `V$CONTAINERS` view shows the name, DBID, UID, and GUID for each container in a CDB.

**Example 19-13 Returning the Container ID Based on the Container Name**

```
SELECT CON_NAME_TO_ID('HRPDB') FROM DUAL;
```

**Example 19-14 Returning the Container ID Based on the Container DBID**

```
SELECT CON_DBID_TO_ID(2226957846) FROM DUAL;
```

 **See Also:**

- ["About a Multitenant Environment"](#)
- ["About the Current Container"](#)
- ["Viewing Information About the Containers in a CDB"](#)
- *Oracle Database Reference* for more information about the `V$CONTAINERS` view

## 19.9 Listing the Modifiable Initialization Parameters in PDBs

In a CDB, some initialization parameters apply to the root and to all PDBs. When such an initialization parameter is changed, it affects the entire CDB. You can set other initialization parameters to different values in each container.

For example, you might have a parameter set to one value in the root, set to another value in one PDB, and set to yet another value in a second PDB.

The query in this section lists the initialization parameters that you can set independently in each PDB.

**To list the initialization parameters that are modifiable in each container:**

1. In SQL\*Plus, access a container.  
See ["About Container Access in a CDB"](#).
2. Run the following query:

```
SELECT NAME FROM V$SYSTEM_PARAMETER  
WHERE ISPDB_MODIFIABLE = 'TRUE'  
ORDER BY NAME;
```

If an initialization parameter listed by this query is not set independently for a PDB, then the PDB inherits the parameter value of the root.

 **See Also:**

- ["Modifying a CDB with ALTER SYSTEM"](#)
- ["Modifying a PDB at the System Level"](#)

## 19.10 Viewing the History of PDBs

The `CDB_PDB_HISTORY` view shows the history of the PDBs in a CDB. It provides information about when and how each PDB was created and other information about each PDB's history.

To view the history of each PDB:

1. In SQL\*Plus, ensure that the current container is the root.  
See ["Accessing a Container in a CDB with SQL\\*Plus"](#).
2. Query `CDB_PDB_HISTORY` view.

### Example 19-15 Viewing the History of PDBs

This example shows the following information about each PDB's history:

- The `DB_NAME` field shows the CDB that contained the PDB.
- The `CON_ID` field shows the container ID of the PDB.
- The `PDB_NAME` field shows the name of the PDB in one of its incarnations.
- The `OPERATION` field shows the operation performed in the PDB's history.
- The `OP_TIMESTAMP` field shows the date on which the operation was performed.
- If the PDB was cloned in an operation, then the `CLONED_FROM_PDB` field shows the PDB from which the PDB was cloned.

```
COLUMN DB_NAME FORMAT A10
COLUMN CON_ID FORMAT 999
COLUMN PDB_NAME FORMAT A15
COLUMN OPERATION FORMAT A16
COLUMN OP_TIMESTAMP FORMAT A10
COLUMN CLONED_FROM_PDB_NAME FORMAT A15

SELECT DB_NAME, CON_ID, PDB_NAME, OPERATION, OP_TIMESTAMP, CLONED_FROM_PDB_NAME
FROM CDB_PDB_HISTORY
WHERE CON_ID > 2
ORDER BY CON_ID;
```

Sample output:

DB_NAME	CON_ID	PDB_NAME	OPERATION	OP_TIMESTAMP	CLONED_FROM_PDB
NEWCDB	3	HRPDB	CREATE	10-APR-12	PDB\$SEED
NEWCDB	4	SALESPDB	CREATE	17-APR-12	PDB\$SEED
NEWCDB	5	TESTPDB	CLONE	30-APR-12	SALESPDB

 **Note:**

When the current container is a PDB, the `CDB_PDB_HISTORY` view shows the history of the current PDB only. A local user whose current container is a PDB can query the `DBA_PDB_HISTORY` view and exclude the `CON_ID` column from the query to view the history of the current PDB.

 **See Also:**

["About the Current Container"](#)

## 19.11 Viewing Information About Applications in Application Containers

Several views provide information about the applications in application containers in a CDB.

This section contains the following topics:

- [Viewing Information About Applications](#)  
The `DBA_APPLICATIONS` view provides information about the applications in an application container.
- [Viewing Information About Application Status](#)  
The `DBA_APP_PDB_STATUS` view provides information about the status of the applications in an application container. It can show the status of each application in each application PDB.
- [Viewing Information About Application Statements](#)  
The `DBA_APP_STATEMENTS` view provides information about SQL statements issued during application installation, upgrade, and patch operations
- [Viewing Information About Application Versions](#)  
The `DBA_APP_VERSIONS` view provides information about the versions for applications in an application container.
- [Viewing Information About Application Patches](#)  
The `DBA_APP_PATCHES` view provides information about the patches for applications in an application container.
- [Viewing Information About Application Errors](#)  
The `DBA_APP_ERRORS` view provides information errors raised when an application PDB synchronizes with an application in the application root.
- [Listing the Shared Database Objects in an Application Container](#)  
The `DBA_OBJECTS` view can list the shared database objects in an application container.
- [Listing the Extended Data-Linked Objects in an Application Container](#)  
The `DBA_TABLES` and `DBA_VIEWS` views can list the extended data-linked objects in an application container.

**Related Topics**

- [Creating and Removing Application Containers](#)  
You can create application containers in several different ways, including using the PDB seed, cloning an existing PDB or non-CDB, and plugging in an unplugged PDB. You can also remove application containers from a CDB.
- [Administering Application Containers](#)  
You can administer application containers, including application roots and application PDBs. You can also administer the applications installed in application containers.

## 19.11.1 Viewing Information About Applications

The `DBA_APPLICATIONS` view provides information about the applications in an application container.

**Note:**

The `DBA_APPLICATIONS` view provides information about the application in the current container only. To view information about applications in all of the application PDBs in the current application container, query the `DBA_APP_PDB_STATUS` with the application root as the current container.

To view information about the applications in an application container:

1. In SQL\*Plus, access the application root of the application container.
2. Query the `DBA_APPLICATIONS` view.

**Example 19-16 Viewing Details About the Applications in an Application Container**

This query shows the name, the latest version, and the status of each user-created application in the application container.

```
COLUMN APP_NAME FORMAT A15
COLUMN APP_VERSION FORMAT A15
COLUMN APP_STATUS FORMAT A15

SELECT APP_NAME, APP_VERSION, APP_STATUS
FROM   DBA_APPLICATIONS
WHERE  APP_IMPLICIT='N';
```

The following sample output shows the `salesapp` application:

APP_NAME	APP_VERSION	APP_STATUS
SALESAPP	1.2	NORMAL

 **Note:**

Oracle Database creates some applications implicitly when an application common user operation is issued with a `CONTAINER=ALL` clause outside of `ALTER PLUGGABLE DATABASE APPLICATION BEGIN/END` statements. The sample query excludes implicitly-created applications by specifying `APP_IMPLICIT='N'` in the `WHERE` clause.

**Related Topics**

- [Administering Application Containers](#)  
You can administer application containers, including application roots and application PDBs. You can also administer the applications installed in application containers.
- [Synchronizing Applications in an Application PDB](#)  
Synchronizing an application updates the application in the application PDB to the latest version and patch in the application root.

## 19.11.2 Viewing Information About Application Status

The `DBA_APP_PDB_STATUS` view provides information about the status of the applications in an application container. It can show the status of each application in each application PDB.

The view can show the status of an application in an application PDB even if the application PDB is closed.

 **Note:**

When queried from the application root, the `DBA_APP_PDB_STATUS` view provides information about the applications in all application PDBs in the current application container. To view information about the application in the current container only, query the `DBA_APPLICATIONS` view.

**To view information about the application status in an application container:**

1. In SQL\*Plus, access the application root of the application container.  
See "[About Container Access in a CDB](#)".
2. Query the `DBA_APP_PDB_STATUS` view.

**Example 19-17 Viewing Information About Application Status**

This query shows the name of the application PDB, the name of the application, the version number of the application, and the status of the application.

```
COLUMN PDB_NAME FORMAT A15
COLUMN APP_NAME FORMAT A15
COLUMN APP_VERSION FORMAT A20
COLUMN APP_STATUS FORMAT A12
```

```
SELECT p.PDB_NAME, s.APP_NAME, s.APP_VERSION, s.APP_STATUS
```

```
FROM DBA_PDBS p, DBA_APP_PDB_STATUS s
WHERE p.CON_UID = s.CON_UID;
```

Your output is similar to the following:

PDB_NAME	APP_NAME	APP_VERSION	APP_STATUS
SALES1	SALESAPP	4.2	NORMAL

#### Note:

The status of an application can be `NORMAL` in an application PDB even when the application has not been synchronized to the latest version. Other statuses might indicate that an operation is in progress or that an operation encountered a problem. For example, the status `UPGRADING` might indicate that an upgrade of the application is in progress in the application PDB, or it might indicate that an error was encountered when the application PDB tried to upgrade an application.

#### See Also:

["Administering Application Containers"](#)

## 19.11.3 Viewing Information About Application Statements

The `DBA_APP_STATEMENTS` view provides information about SQL statements issued during application installation, upgrade, and patch operations

Oracle Database records all of the SQL statements issued during application installation, upgrade, and patch operations, and you can view the history of these statements by querying the `DBA_APP_STATEMENTS` view.

**To view information about the SQL statements issued during application operations:**

1. In SQL\*Plus, access the application root of the application container.  
See ["About Container Access in a CDB"](#).
2. Query the `DBA_APP_STATEMENTS` view.

### **Example 19-18 Viewing Information About Application Statements**

This query shows the statement ID, capture time, SQL statement, and application name for the SQL statements for applications in the application container.

```
SET LONG 8000
SET PAGES 8000
COLUMN STATEMENT_ID FORMAT NNNNN
COLUMN CAPTURE_TIME FORMAT A12
```

```
COLUMN APP_STATEMENT FORMAT A36
COLUMN APP_NAME FORMAT A15
```

```
SELECT STATEMENT_ID, CAPTURE_TIME, APP_STATEMENT, APP_NAME
FROM DBA_APP_STATEMENTS
ORDER BY STATEMENT_ID;
```

Your output is similar to the following:

```
STATEMENT_ID CAPTURE_TIME APP_STATEMENT APP_NAME
-----
1 30-AUG-15 SYS
APP$1E87C094764
1142FE0534018F8
0AA6C5
2 30-AUG-15 ALTER PLUGGABLE DATABASE APPLICATION
APP$1E87C094764
APP$CON BEGIN INSTALL '1.0'
1142FE0534018F8
0AA6C5
3 30-AUG-15 ALTER PLUGGABLE DATABASE APPLICATION
APP$1E87C094764
APP$CON END INSTALL '1.0'
1142FE0534018F8
0AA6C5
4 30-AUG-15 SYS SALESAPP
5 30-AUG-15 ALTER PLUGGABLE DATABASE APPLICATION SALESAPP
salesapp BEGIN INSTALL '1.0'
6 30-AUG-15 CREATE TABLE oe.cmtb SHARING=METADAT SALESAPP
A (
value VARCHAR2(30),
country VARCHAR2(30))
7 30-AUG-15 CREATE TABLE conmap ( SALESAPP
country VARCHAR2(30) NOT NULL)
PARTITION BY LIST (country) (
PARTITION AMER VALUES ('US','MEXICO'
,'CANADA'),
PARTITION EURO VALUES ('UK','FRANCE'
,'GERMANY'),
PARTITION ASIA VALUES ('INDIA','CHIN
A','JAPAN'))
8 30-AUG-15 ALTER TABLE oe.cmtb ENABLE CONTAINER SALESAPP
_MAP
9 30-AUG-15 ALTER PLUGGABLE DATABASE APPLICATION SALESAPP
salesapp END INSTALL '1.0'
.
.
.
```



 **Note:**

Oracle Database creates some applications implicitly when an application common user operation is issued with a `CONTAINER=ALL` clause outside of `ALTER PLUGGABLE DATABASE APPLICATION BEGIN/END` statements. The names of these applications begin with `APP$`, and the sample output shows these applications.

 **See Also:**

- ["Administering Application Containers"](#)
- ["Synchronizing Applications in an Application PDB"](#)

## 19.11.4 Viewing Information About Application Versions

The `DBA_APP_VERSIONS` view provides information about the versions for applications in an application container.

Oracle Database records the versions for each application in an application container.

**To view information about the application versions in an application container:**

1. In SQL\*Plus, access the application root of the application container.  
See ["About Container Access in a CDB"](#).
2. Query the `DBA_APP_VERSIONS` view.

### Example 19-19 Viewing Information About Application Versions

This query shows the name of the application that was versioned, the version number, and the comment for the version.

```
COLUMN APP_NAME FORMAT A15
COLUMN APP_VERSION FORMAT A20
COLUMN APP_VERSION_COMMENT FORMAT A25

SELECT APP_NAME, APP_VERSION, APP_VERSION_COMMENT
FROM DBA_APP_VERSIONS;
```

Your output is similar to the following:

APP_NAME	APP_VERSION	APP_VERSION_COMMENT
-----	-----	-----
SALESAPP	1.0	Sales Application

 **See Also:**  
"Administering Application Containers"

## 19.11.5 Viewing Information About Application Patches

The `DBA_APP_PATCHES` view provides information about the patches for applications in an application container.

Oracle Database records the patches for each application in an application container.

**To view information about the application patches in an application container:**

1. In SQL\*Plus, access the application root of the application container.  
See "[About Container Access in a CDB](#)".
2. Query the `DBA_APP_PATCHES` view.

### Example 19-20 Viewing Information About Application Patches

This query shows the name of the application that was patched, the patch number, the minimum application version for the patch, and the status of the patch for each patch in the application container.

```
COLUMN APP_NAME FORMAT A15
COLUMN PATCH_NUMBER FORMAT NNNNNNNN
COLUMN PATCH_MIN_VERSION FORMAT A10
COLUMN PATCH_STATUS FORMAT A15

SELECT APP_NAME, PATCH_NUMBER, PATCH_MIN_VERSION, PATCH_STATUS
FROM DBA_APP_PATCHES;
```

Your output is similar to the following:

APP_NAME	PATCH_NUMBER	PATCH_MIN_	PATCH_STATUS
SALESAPP	1	1.2	INSTALLED

 **See Also:**  
"Administering Application Containers"

## 19.11.6 Viewing Information About Application Errors

The `DBA_APP_ERRORS` view provides information errors raised when an application PDB synchronizes with an application in the application root.

An application PDB issues the `ALTER PLUGGABLE DATABASE APPLICATION` statement with the `SYNC` clause. You can view the history of application errors during application synchronization by querying the `DBA_APP_ERRORS` view.

**To view information about errors raised during application synchronization:**

1. In SQL\*Plus, access the application root of the application container.  
See "[About Container Access in a CDB](#)".
2. Query the `DBA_APP_ERRORS` view.

### Example 19-21 Viewing Details About Errors Raised During Application Synchronization

This query shows the application name, the SQL statement that raised the error, the error number, and the error message for errors raised during application synchronization.

```
SET LONG 8000
SET PAGES 8000
COLUMN APP_NAME FORMAT A15
COLUMN APP_STATEMENT FORMAT A36
COLUMN ERRORNUM FORMAT NNNNNNNN
COLUMN ERRORMSG FORMAT A20

SELECT APP_NAME, APP_STATEMENT, ERRORNUM, ERRORMSG
FROM DBA_APP_ERRORS;
```



#### See Also:

"[Administering Application Containers](#)"

## 19.11.7 Listing the Shared Database Objects in an Application Container

The `DBA_OBJECTS` view can list the shared database objects in an application container.

Shared database objects are metadata-linked application common objects, data-linked application common objects, and extended data-linked application common objects.

**To list the shared database objects in an application container:**

1. In SQL\*Plus, access the application root of the application container.  
See "[About Container Access in a CDB](#)".

2. Query the `DBA_OBJECTS` view and specify the `SHARING` column.

**Example 19-22 Listing the User-Created Shared Database Objects in an Application Container**

This query shows the owner and name of the user-created shared database objects in the application container. It also shows whether each shared database object is a metadata-linked application common object or a data-linked application common object. The query excludes Oracle-supplied shared database objects.

```
COLUMN OWNER FORMAT A15
COLUMN OBJECT_NAME FORMAT A25
COLUMN SHARING FORMAT A13

SELECT OWNER, OBJECT_NAME, SHARING
       FROM DBA_OBJECTS WHERE SHARING != 'NONE'
       AND ORACLE_MAINTAINED = 'N';
```

Your output is similar to the following:

OWNER	OBJECT_NAME	SHARING
SALESADM	CONMAP	METADATA LINK
OE	PRODUCT_DESCRIPTIONS_OB	DATA LINK
OE	CMTB	METADATA LINK

 **See Also:**  
["Managing Application Common Objects"](#)

## 19.11.8 Listing the Extended Data-Linked Objects in an Application Container

The `DBA_TABLES` and `DBA_VIEWS` views can list the extended data-linked objects in an application container.

An extended data-linked object is a special type of data-linked object for which each application PDB can create its own specific data while sharing the common data in the application root. Only the data stored in the application root is common for all application PDBs.

**To list the extended data-linked objects in an application container:**

1. In SQL\*Plus, access the application root of the application container.  
 See ["About Container Access in a CDB"](#).
2. Query the `DBA_TABLES` or `DBA_VIEWS` view and specify the `EXTENDED_DATA_LINK='YES'` in the `WHERE` clause.

### Example 19-23 Listing the Extended Data-Linked Tables in an Application Container

This query shows the owner and name of the extended data-linked tables in the application container.

```
COLUMN OWNER FORMAT A20  
COLUMN TABLE_NAME FORMAT A30  
  
SELECT OWNER, TABLE_NAME FROM DBA_TABLES WHERE EXTENDED_DATA_LINK='YES';
```

Your output is similar to the following:

OWNER	TABLE_NAME
SALESADM	ZIPCODES



#### See Also:

["Managing Application Common Objects"](#)

# Part V

## Using Oracle Features in a Multitenant Environment

You can use Oracle Database features in a multitenant environment.

This part contains the following chapters:

- [Backing Up and Recovering CDBs and PDBs](#)  
You can back up and recover multitenant container databases (CDBs) and pluggable databases (PDBs).
- [Using Oracle Resource Manager for PDBs](#)  
Use PL/SQL package procedures to administer Oracle Resource Manager (Resource Manager) to allocate resources to pluggable databases (PDBs) in a multitenant container database (CDB).
- [Using Oracle Scheduler with a CDB](#)  
You can use Oracle Scheduler to schedule jobs in a multitenant container database (CDB).
- [Using Oracle Database Vault with a CDB](#)  
You can use Oracle Database Vault in a multitenant container database (CDB).
- [Using XStream with a CDB](#)  
You can use Oracle Database XStream in a multitenant container database (CDB).

# Backing Up and Recovering CDBs and PDBs

You can back up and recover multitenant container databases (CDBs) and pluggable databases (PDBs).

This section contains the following topics:

- [Overview of Backing Up and Recovering CDBs and PDBs](#)  
When using the multitenant architecture, you can perform backup and recovery operations on a whole multitenant container database (CDB), the root, or one or more pluggable databases (PDBs).
- [Backup and Complete Recovery of CDBs](#)  
To perform backup and complete recovery operations on a whole multitenant container database (CDB), you connect as `TARGET` to the root.
- [Backup and Complete Recovery of PDBs](#)  
You can perform backup and complete recovery operations on a single pluggable database (PDB) or on multiple PDBs.
- [Point-in-Time Recovery in a Multitenant Environment](#)  
You can perform point-in-time recovery of the whole multitenant container database (CDB) or a particular pluggable database (PDB).
- [Flashback Database in a Multitenant Environment](#)  
You can perform a Flashback Database operation for a whole multitenant container database (CDB) or for a particular pluggable (PDB).

## 20.1 Overview of Backing Up and Recovering CDBs and PDBs

When using the multitenant architecture, you can perform backup and recovery operations on a whole multitenant container database (CDB), the root, or one or more pluggable databases (PDBs).

The Oracle Recovery Manager (RMAN) commands used to backup and recover CDBs and PDBs are the same as those used for non-CDBs, with minor variations in the syntax. The backup and recovery operations performed on non-CDBs can also be performed on CDBs and PDBs. This includes the following:

- Full and incremental backups
- Complete and point-in-time recovery (PITR)
- Flashback Database
- Reporting operations (such as listing backups and cross-checking backups)

### About Connecting to CDBs and PDBs

You can connect to the root in one of the following ways:

- Connect using operating system authentication  
You are connected to the root as the SYS user with the SYSDBA privilege.
- Connect locally as a common user
- Connect as a common user through Oracle Net Services

To connect as TARGET to a PDB, use one of the following techniques:

- Connect with a net service name that resolves to a database service for that PDB
- Connect locally as a common user or local user with the SYSDBA or SYSBACKUP privilege

 **Note:**

Certain operations are not available when you connect directly to a PDB. See *Oracle Database Backup and Recovery User's Guide* for a list of these operations.

 **See Also:**

The following sections in the *Oracle Database Backup and Recovery User's Guide* provide detailed information about backing up and recovering PDBs:

- Connecting as Target to the Root
- Connecting as Target to a PDB

## 20.2 Backup and Complete Recovery of CDBs

To perform backup and complete recovery operations on a whole multitenant container database (CDB), you connect as TARGET to the root.

The connection must be established as a common user with the SYSDBA or SYSBACKUP privilege.

After you connect to the root, the same commands that are used to perform operations on non-CDBs are used to perform backup and complete recovery on the entire CDB.



 **See Also:**

The following sections in the *Oracle Database Backup and Recovery User's Guide* provide detailed information about performing backup and complete recovery of CDBs:

- "Backing Up a Whole CDB"
- "Performing Complete Recovery of a Whole CDB"
- "Validating a Whole CDB"
- "Reporting in CDBs"

## 20.3 Backup and Complete Recovery of PDBs

You can perform backup and complete recovery operations on a single pluggable database (PDB) or on multiple PDBs.

### Backups of PDBs

When relocating a PDB or cloning a non-CDB as a PDB, you may want to retain the use of preplugin backups. For preplugin backups to be usable in the destination CDB, metadata about the preplugin backups must be exported to the RMAN repository of the destination CDB.

The technique for making the backups usable depends on the type of operation:

- Creating a PDB by cloning a non-CDB

When the non-CDB is opened in read/write mode, you must execute the `DBMS_PDB.EXPORTRMANBACKUP` procedure as the last step before cloning. When plugging in the non-CDB as a PDB to a destination CDB, the operation copies the backup metadata of the source non-CDB into the data dictionary of the destination CDB.

- Relocating a PDB to another CDB

When you unplug the source PDB, the backup metadata is automatically exported. Therefore, you do not need to execute `DBMS_PDB.EXPORTRMANBACKUP`.

Preplugin backups are usable only on the destination CDB into which you plug in the source non-CDB or PDB.

 **Note:**

- *Oracle Database Backup and Recovery User's Guide* to learn about preplugin backups
- *Oracle Database Backup and Recovery User's Guide* to learn how to create a preplugin backup of the whole database
- *Oracle Database PL/SQL Packages and Types Reference* to learn more about the `DBMS_PDB.EXPORTRMANBACKUP` procedure

### Syntax for Backup Commands

Although the Oracle Recovery Manager (RMAN) commands are the same, the syntax used to perform operations on multiple PDBs contains some modifications.

To perform backup and complete recovery operations on a single PDB, you can connect as `TARGET` to either of the following containers:

- `PDB`  
In this case, use the same commands that you would use to backup or recover non-CDBs. For example, to back up a PDB, use the `BACKUP DATABASE` command.
- `CDB$ROOT`  
In this case, use the `PLUGGABLE DATABASE` clause in your RMAN commands. The following command backs up the PDB `hrpdb` when connected to the root:

```
BACKUP PLUGGABLE DATABASE hrpdb;
```

To perform backup and complete recovery operations on multiple PDBs using a single command, you must connect to the root. Use the `PLUGGABLE DATABASE` clause followed by the list of PDBs on which you want to perform the operation. The following example backs up the PDBs `hrpdb`, `salespdb`, and `invpdb` when connected to the root:

```
BACKUP PLUGGABLE DATABASE hrpdb, salespdb, invpdb;
```

#### See Also:

The following sections in the *Oracle Database Backup and Recovery User's Guide* provide detailed information about backing up and recovering PDBs:

- "Connecting as Target to a PDB"
- "Connecting as Target to the Root"
- "Backing Up PDBs with RMAN"
- "Performing Complete Recovery of PDBs with RMAN"
- "Validating PDBs"
- "Reporting in PDBs"

## 20.4 Point-in-Time Recovery in a Multitenant Environment

You can perform point-in-time recovery of the whole multitenant container database (CDB) or a particular pluggable database (PDB).

### Point-in-Time Recovery of a CDB

To perform point-in-time recovery of a CDB, you must meet the following prerequisites:

- You must be logged in to the root container as a common user with the `SYSDBA` or `SYSBACKUP` privilege.
- The CDB must be mounted.

When performing the recovery operation, use the same commands that you use for non-CDBs.

### Point-in-Time Recovery of a PDB

When a PDB is closed in an open or closed CDB, you can recover the PDB to a past point in time. The technique depends on the undo mode of the CDB. The following table describes the differences.

**Table 20-1 Differences in Point-in-Time Recovery Techniques**

Undo Mode	Auxiliary Instance Used?	Connect as TARGET to ...	RMAN Commands to Use for Recovery
Shared	Yes	CDB root	Include the <code>PLUGGABLE DATABASE</code> clause to specify the PDB that must be recovered.  RMAN uses an auxiliary destination to store temporary files created during recovery. If a fast recovery area has been configured, then it is used as the auxiliary destination. You can explicitly specify an auxiliary destination using the <code>AUXILIARY DESTINATION</code> clause in the <code>RECOVER</code> command.
Local	No	CDB root or PDB	When connected to the PDB, use the same commands that you use for non-CDBs. When connected to the root, include the <code>PLUGGABLE DATABASE</code> clause to specify the PDB that must be recovered.

#### See Also:

The following sections in the *Oracle Database Backup and Recovery User's Guide* for more information about point-in-time recovery.

- "Overview of Restore Points in a Multitenant Environment"
- "Creating CDB Restore Points"
- "Creating PDB Restore Points"
- "Performing Point-in-Time Recovery of CDBs and PDBs"

## 20.5 Flashback Database in a Multitenant Environment

You can perform a Flashback Database operation for a whole multitenant container database (CDB) or for a particular pluggable (PDB).

RMAN uses an auxiliary destination to store temporary files created during point-in-time recovery. By default, the fast recovery area is used as the auxiliary destination.

You can explicitly specify an auxiliary destination using the `AUXILIARY DESTINATION` clause in the `RECOVER` command.

### Flashback of CDBs

To perform Flashback Database for a CDB, you must meet the following prerequisites:

- You must be connected to the root as a common user with the `SYSDBA` or `SYSBACKUP` privilege.
- The CDB must be mounted.

Specify the target point in time for the flashback operation using a CDB restore point, time expression, or SCN. A CDB restore point is accessible to every PDB within the CDB. However, the restore point does not reflect the PDB sub-incarnation of any of its PDBs.

### Flashback of PDBs

When a PDB is closed and the CDB is open, you can perform a flashback database operation for this PDB using the `FLASHBACK DATABASE` command. Performing a Flashback Database operation on a particular PDB modifies only data files related to that PDB. The other PDBs in the CDB are not impacted and are available for use. Note that a PDB restore point is accessible only to the PDB in which it is defined and can be used for operations only on this PDB.

**Table 20-2 Differences in Flashback Techniques**

CDB Undo Mode	Auxiliary Instance Used?	Connect as TARGET to ...	Commands
Shared	Yes	CDB root	Use the <code>FLASHBACK PLUGGABLE DATABASE</code> command. You can only flash back to a clean PDB restore point.  RMAN uses an auxiliary destination to store temporary files created during flashback. If a fast recovery area has been configured, then it is used as the auxiliary destination. You can explicitly specify an auxiliary destination using the <code>AUXILIARY DESTINATION</code> clause in the <code>FLASHBACK PLUGGABLE DATABASE</code> command.
Local	No	CDB root or PDB	Use the <code>FLASHBACK PLUGGABLE DATABASE</code> command. You can specify the target point in time for the flashback operation using a CDB restore point, PDB restore point, time expression, or target SCN.

 **See Also:**

The following sections in the *Oracle Database Backup and Recovery User's Guide* for more information about flashback of CDBs and PDBs:

- "Overview of Restore Points in a Multitenant Environment"
- "Creating CDB Restore Points"
- "Creating PDB Restore Points"
- "Performing a Flashback Database Operation for a Whole CDB"
- "Performing a Flashback Database Operation for PDBs"

# 21

## Using Oracle Resource Manager for PDBs

Use PL/SQL package procedures to administer Oracle Resource Manager (Resource Manager) to allocate resources to pluggable databases (PDBs) in a multitenant container database (CDB).

This chapter assumes that you meet the following prerequisites:

- You understand how to configure and manage a CDB.
- You understand how to use Resource Manager to allocate resources in a non-CDB.

### Note:

- You can complete the tasks in this chapter using SQL\*Plus or Oracle SQL Developer.
- You can also administer the Resource Manager with the graphical user interface of Oracle Enterprise Manager Cloud Control (Cloud Control).
- For simplicity, this chapter refers to PDBs, application roots, and application PDBs as “PDBs.”

This chapter contains the following topics:

- [Overview of Oracle Resource Manager in a Multitenant Environment](#)  
In a CDB, workloads within multiple PDBs can compete for system and CDB resources. Resource plans solve this problem.
- [Managing CDB Resource Plans](#)  
In a CDB, PDBs might have different levels of priority. You can create CDB resource plans to distribute resources to different PDBs based on these priorities.
- [Managing PDB Resource Plans](#)  
You can create, enable, and modify resource plans for individual PDBs.
- [Monitoring PDBs Managed by Oracle Database Resource Manager](#)  
A set of dynamic performance views enables you to monitor the results of your Oracle Database Resource Manager settings for PDBs.

 **See Also:**

- ["Administering a Multitenant Environment"](#)
- [" Using Oracle Resource Manager for PDBs with Cloud Control"](#) to learn about administering Resource Manager in a CDB with Cloud Control
- *Oracle Database Administrator's Guide* to learn more about Resource Manager

## 21.1 Overview of Oracle Resource Manager in a Multitenant Environment

In a CDB, workloads within multiple PDBs can compete for system and CDB resources. Resource plans solve this problem.

In a multitenant environment, Resource Manager operates on two levels:

- CDB level  
Resource Manager can manage the workloads for multiple PDBs that are contending for system and CDB resources. You can specify how resources are allocated to PDBs, and you can limit the resource utilization of specific PDBs. The principal tool is a CDB resource plan.
- PDB level  
Resource Manager can manage the workloads within each PDB. The principal tool is a PDB resource plan.

Resource Manager allocates the resources in two steps:

1. It allocates a portion of the system's resources to each PDB.
2. In a specific PDB, it allocates a portion of system resources obtained in the preceding step to each session connected to the PDB.

 **Note:**

Resource Manager manages activity in the root automatically.

To use Resource Manager in a multitenant environment, you must meet the following prerequisites:

- The CDB must exist and must contain PDBs.
- To complete a task that uses the `DBMS_RESOURCE_MANAGER` package, you must have `ADMINISTER_RESOURCE_MANAGER` system privilege.

This section contains the following topics:

- [Purpose of Resource Management in a Multitenant Environment](#)  
Resource Manager can provide more efficient use of resources for a CDB.

- [Overview of Resource Plan Directives](#)  
A **CDB resource plan** allocates resources to its PDBs according to its set of resource plan directives (directives).
- [Background and Administrative Tasks and Consumer Groups](#)  
In a CDB, background and administrative tasks map to the Resource Manager consumer groups that run them optimally.
- [Initialization Parameters for Multitenant Resource Management](#)  
Use initialization parameters for control memory and I/O in a PDB.

 **See Also:**

- " [Creating and Configuring a CDB](#)" and " [Creating and Removing PDBs and Application Containers](#)"
- *Oracle Database Administrator's Guide* to learn more about the `DBMS_RESOURCE_MANAGER` package

## 21.1.1 Purpose of Resource Management in a Multitenant Environment

Resource Manager can provide more efficient use of resources for a CDB.

When resource allocation decisions for a CDB are left to the operating system, you may encounter the following problems with workload management:

- **Inappropriate allocation of resources among PDBs**  
The operating system distributes resources equally among all active processes and cannot prioritize one task over another. Therefore, one or more PDBs might use an inordinate amount of the system resources, leaving the other PDBs starved for resources.
- **Inappropriate allocation of resources within a single PDB**  
One or more sessions connected to a single PDB might use an inordinate amount of the system resources, leaving other sessions connected to the same PDB starved for resources.
- **Inconsistent performance of PDBs**  
A single PDB might perform inconsistently when other PDBs are competing for more system resources or less system resources at various times.
- **Lack of resource usage data for PDBs**  
Resource usage data is critical for monitoring and tuning PDBs. It might be possible to use operating system monitoring tools to gather the resource usage data for a non-CDB if it is the only database running on the system. However, in a CDB, operating system monitoring tools are no longer as useful because there are multiple PDBs running on the system.

Resource Manager helps to overcome these problems by allowing the CDB more control over how hardware resources are allocated among the PDBs and within PDBs.



In a CDB with multiple PDBs, some PDBs typically are more important than others. The Resource Manager enables you to prioritize and limit the resource usage of specific PDBs. With the Resource Manager, you can:

- Specify that different PDBs should receive different shares of the system resources so that more resources are allocated to the more important PDBs
- Limit the CPU usage of a particular PDB
- Limit the number of parallel execution servers that a particular PDB can use
- Limit the memory usage of a particular PDB
- Specify the amount of memory guaranteed for a particular PDB
- Specify the maximum amount of memory a particular PDB can use
- Use PDB performance profiles for different sets of PDB

A performance profile for a set of PDBs can specify shares of system resources, CPU usage, and number of parallel execution servers. PDB performance profiles enable you to manage resources for large numbers of PDBs by specifying Resource Manager directives for profiles instead of individual PDBs.

- Limit the resource usage of different sessions connected to a single PDB
- Limit the I/O generated by specific PDBs
- Monitor the resource usage of PDBs

## 21.1.2 Overview of Resource Plan Directives

A **CDB resource plan** allocates resources to its PDBs according to its set of resource plan directives (directives).

A parent-child relationship exists between a CDB resource plan and its resource plan directives. Each directive references either a set of PDBs in a performance profile, or a single PDB.

You can specify directives for both individual PDBs and for PDB performance profiles in the same CDB. No two directives for the currently active plan can reference the same PDB or the same PDB performance profile.

This section contains the following topics:

- [PDB Performance Profiles](#)  
A **PDB performance profile** configures resource plan directives for a set of PDBs that have the same priorities and resource controls.
- [Resource Plan Directives](#)  
Directives control allocation of CPU and parallel execution servers.

### 21.1.2.1 PDB Performance Profiles

A **PDB performance profile** configures resource plan directives for a set of PDBs that have the same priorities and resource controls.

For example, you might create a performance profiles called Gold, Silver, and Bronze. Each profile specifies a different set of directives depending on the importance of the type of PDB. Gold PDBs are more mission critical than Silver PDBs, which are more mission critical than Bronze PDBs. A PDB specifies its performance profile with the `DB_PERFORMANCE_PROFILE` initialization parameter.

You can use PDB lockdown profiles to specify PDB initialization parameters that control resources, such as `SGA_TARGET` and `PGA_AGGREGATE_LIMIT`. A lockdown profile prevents the PDB administrator from modifying the settings.

Oracle recommends using matching names for performance profiles and lockdown profiles. To prevent PDB owners from switching profiles, Oracle recommends putting the PDB performance profile in the PDB lockdown profile.

### 21.1.2.2 Resource Plan Directives

Directives control allocation of CPU and parallel execution servers.

A directive can control the allocation of resources to PDBs based on the share value that you specify for each PDB or PDB performance profile. A higher share value results in more resources. For example, you can specify that one PDB is allocated double the resources allocated to a second PDB by setting the share value for the first PDB twice as high as the share value for the second PDB. Similarly, you can specify that one PDB performance profile is allocated double the resources allocated to a second PDB performance profile by setting the share value for the first PDB performance profile twice as high as the share value for the second PDB performance profile. The settings apply to the set of PDBs that use each profile.

You can also specify utilization limits for PDBs and PDB performance profiles. The limit controls allocation to the PDB or performance profile. For example, the limit can control how much CPU a PDB gets as a percentage of the total CPU available to the CDB.

You can use both shares and utilization limits together for precise control over the resources allocated to each PDB and PDB performance profile in a CDB.



#### See Also:

["About Restricting PDB Users for Enhanced Security"](#) for more information about PDB lockdown profiles

### 21.1.3 Background and Administrative Tasks and Consumer Groups

In a CDB, background and administrative tasks map to the Resource Manager consumer groups that run them optimally.

Resource Manager uses the following rules to map a task to a consumer group:

- A task is mapped to a consumer group in the container that starts the task.  
If a task starts in the CDB root, then the task maps to a consumer group in the CDB root. If the task starts in a PDB, then the task maps to a consumer group in the PDB.
- Many maintenance and administrative tasks automatically map to a consumer group.

For example, automated maintenance tasks map to `ORA$AUTOTASK`. In certain cases, the tasks map to a consumer group, but the mapping is modifiable. Such

tasks include RMAN backup, RMAN image copy, Oracle Data Pump, and In-Memory population.



**Note:**

*Oracle Database Administrator's Guide* to learn more about the mapping rules for predefined consumer groups

## 21.1.4 Initialization Parameters for Multitenant Resource Management

Use initialization parameters for control memory and I/O in a PDB.

This section contains the following topics:

- [Memory-Related Initialization Parameters for PDBs](#)  
Several initialization parameters control the memory usage of a PDB.
- [I/O-Related Initialization Parameters for PDBs](#)  
The `MAX_IOPS` and `MAX_MBPS` initialization parameters limit the disk I/O generated by a PDB.
- [CPU-Related Initialization Parameters for PDBs](#)  
The `CPU_COUNT` initialization parameter specifies the number of CPUs available for Oracle Database to use.

### 21.1.4.1 Memory-Related Initialization Parameters for PDBs

Several initialization parameters control the memory usage of a PDB.

When the PDB is the current container, the initialization parameters in the following table control the memory usage of the current PDB. When one or more of these parameters is set for a PDB, ensure that the CDB and the other PDBs have sufficient memory for their operations. The initialization parameters control the memory usage of PDBs only if the following conditions are met:

- The `NONCDB_COMPATIBLE` initialization parameter is set to `false` in the CDB root.
- The `MEMORY_TARGET` initialization parameter is not set or is set to 0 (zero) in the CDB root.

**Table 21-1 Initialization Parameters That Control the Memory Usage of PDBs**

Initialization Parameter	Description
DB_CACHE_SIZE	<p>Sets the minimum, guaranteed buffer cache space for the PDB.</p> <p>The following requirements must be met:</p> <ul style="list-style-type: none"> <li>• It must be less than or equal to 50% of the setting for the DB_CACHE_SIZE in the CDB root.</li> <li>• The sum of the DB_CACHE_SIZE settings for all PDBs must be less than or equal to 50% of the setting for the DB_CACHE_SIZE in the CDB root.</li> </ul> <p>These requirements do not apply if the SGA_TARGET initialization parameter is set to a nonzero value in the CDB root.</p> <p>When the SGA_TARGET initialization parameter is set to a nonzero, the following requirements must be met:</p> <ul style="list-style-type: none"> <li>• The values of DB_CACHE_SIZE plus SHARED_POOL_SIZE in a PDB must be less than or equal to 50% of the PDB's SGA_TARGET value.</li> <li>• The values of DB_CACHE_SIZE plus SHARED_POOL_SIZE in a PDB must be less than or equal to 50% of the SGA_TARGET value at the CDB level.</li> <li>• The sum of DB_CACHE_SIZE plus SHARED_POOL_SIZE across all the PDBs in a CDB must be less than or equal to 50% of the SGA_TARGET value at the CDB level.</li> </ul>

**Table 21-1 (Cont.) Initialization Parameters That Control the Memory Usage of PDBs**

Initialization Parameter	Description
SHARED_POOL_SIZE	<p>Sets the minimum, guaranteed shared pool space for the PDB.</p> <p>The following requirements must be met:</p> <ul style="list-style-type: none"> <li>• It must be less than or equal to 50% of the setting for the SHARED_POOL_SIZE in the CDB root.</li> <li>• The sum of the SHARED_POOL_SIZE settings for all PDBs must be less than or equal to 50% of the setting for the SHARED_POOL_SIZE in the CDB root.</li> </ul> <p>These requirements do not apply if the SGA_TARGET initialization parameter is set to a nonzero value in the CDB root.</p> <p>When the SGA_TARGET initialization parameter is set to a nonzero, the following requirements must be met:</p> <ul style="list-style-type: none"> <li>• The values of DB_CACHE_SIZE plus SHARED_POOL_SIZE in a PDB must be less than or equal to 50% of the PDB's SGA_TARGET value.</li> <li>• The values of DB_CACHE_SIZE plus SHARED_POOL_SIZE in a PDB must be less than or equal to 50% of the SGA_TARGET value at the CDB level.</li> <li>• The sum of DB_CACHE_SIZE plus SHARED_POOL_SIZE across all the PDBs in a CDB must be less than or equal to 50% of the SGA_TARGET value at the CDB level.</li> </ul>
SGA_MIN_SIZE	<p>Sets the minimum SGA size for the PDB.</p> <p>The following requirements must be met:</p> <ul style="list-style-type: none"> <li>• It must be less than or equal to 50% of the setting for the SGA_TARGET in the CDB root.</li> <li>• It must be less than or equal to 50% of the setting for the SGA_TARGET in the PDB.</li> <li>• The sum of the SGA_MIN_SIZE settings for all PDBs must be less than or equal to 50% of the setting for the SGA_TARGET in the CDB root.</li> </ul> <p>These requirements do not apply if the SGA_TARGET initialization parameter is not set or is set to 0 (zero) in the CDB root.</p>
SGA_TARGET	<p>Sets the maximum SGA size for the PDB.</p> <p>The SGA_TARGET setting in the PDB is enforced only if the SGA_TARGET initialization parameter is set to a nonzero value in the CDB root. The SGA_TARGET setting in the PDB must be less than or equal to the SGA_TARGET setting in the CDB root.</p>

**Table 21-1 (Cont.) Initialization Parameters That Control the Memory Usage of PDBs**

Initialization Parameter	Description
PGA_AGGREGATE_LIMIT	<p>Sets the maximum PGA size for the PDB.</p> <p>The following requirements must be met:</p> <ul style="list-style-type: none"> <li>• It must be less than or equal to the setting for the PGA_AGGREGATE_LIMIT in the CDB root.</li> <li>• It must be greater than or equal to two times the setting for the PGA_AGGREGATE_TARGET in the PDB.</li> </ul>
PGA_AGGREGATE_TARGET	<p>Sets the target aggregate PGA size for the PDB.</p> <p>The following requirements must be met:</p> <ul style="list-style-type: none"> <li>• It must be less than or equal to the PGA_AGGREGATE_TARGET value set at the CDB level.</li> <li>• It must be less than or equal to 50% of the PGA_AGGREGATE_LIMIT initialization parameter value set at the CDB level.</li> <li>• It must be less than or equal to 50% of the PGA_AGGREGATE_LIMIT value set in the PDB.</li> </ul>

**Example 21-1 Setting the Maximum Aggregate PGA Memory Available for a PDB**

With the PDB as the current container, run the following SQL statement to set the PGA\_AGGREGATE\_LIMIT initialization parameter both in memory and in the SPFILE to 90 MB:

```
ALTER SYSTEM SET PGA_AGGREGATE_LIMIT = 90M SCOPE = BOTH;
```

**Example 21-2 Setting the Minimum SGA Size for a PDB**

With the PDB as the current container, run the following SQL statement to set the SGA\_MIN\_SIZE initialization parameter both in memory and in the SPFILE to 500 MB:

```
ALTER SYSTEM SET SGA_MIN_SIZE = 500M SCOPE = BOTH;
```

### 21.1.4.2 I/O-Related Initialization Parameters for PDBs

The MAX\_IOPS and MAX\_MBPS initialization parameters limit the disk I/O generated by a PDB.

A large amount of disk I/O can cause poor performance. Several factors can result in excess disk I/O, such as poorly designed SQL or index and table scans in high-volume transactions. If one PDB is generating a large amount of disk I/O, then it can degrade the performance of other PDBs in the same CDB.

Use one or both of the following initialization parameters to limit the I/O generated by a specific PDB:

- The `MAX_IOPS` initialization parameter limits the number of I/O operations for each second.
- The `MAX_MBPS` initialization parameter limits the megabytes for I/O operations for each second.

If you set both preceding initialization parameters for a single PDB, then Oracle Database enforces both limits. Note that these limits are *not* enforced for Oracle Exadata, which uses I/O Resource Management (IORM) to manage I/Os between PDBs.

If these initialization parameters are set with the CDB root as the current container, then the values become the default values for all containers in the CDB. If they are set with an application root as the current container, then the values become the default values for all application PDBs in the application container. When they are set with a PDB or application PDB as the current container, then the settings take precedence over the default settings in the CDB root or the application root. These parameters cannot be set in a non-CDB.

The default for both initialization parameters is 0 (zero). If these initialization parameters are set to 0 (zero) in a PDB, and the CDB root is set to 0, then there is no I/O limit for the PDB. If these initialization parameters are set to 0 (zero) in an application PDB, and its application root is set to 0, then there is no I/O limit for the application PDB.

Critical I/O operations, such as ones for the control file and password file, are exempted from the limit and continue to run even if the limit is reached. However, all I/O operations, including critical I/O operations, are counted when the number of I/O operations and the megabytes for I/O operations are calculated.

You can use the `DBA_HIST_RSRC_PDB_METRIC` view to calculate a reasonable I/O limit for a PDB. Consider the values in the following columns when calculating a limit: `IOPS`, `IOMBPS`, `IOPS_THROTTLE_EXEMPT`, and `IOMBPS_THROTTLE_EXEMPT`. The `rsmgr:io rate limit wait` event indicates that a limit was reached.

### Example 21-3 Limiting the I/O Generated by a PDB

With the PDB as the current container, run the following SQL statement to set the `MAX_IOPS` initialization parameter both in memory and in the SPFILE to a limit of 1,000 I/O operations for each second:

```
ALTER SYSTEM SET MAX_IOPS = 1000 SCOPE = BOTH;
```

### Example 21-4 Limiting the Megabytes of I/O Generated by a PDB

With the PDB as the current container, run the following SQL statement to set the `MAX_MBPS` initialization parameter both in memory and in the SPFILE to a limit of 200 MB of I/O for each second:

```
ALTER SYSTEM SET MAX_MBPS = 200 SCOPE = BOTH;
```

 **See Also:**

- ["Modifying a PDB at the System Level"](#)
- *Oracle Database Reference* for more information about the `MAX_IOPS` initialization parameter
- *Oracle Database Reference* for more information about the `MAX_MBPS` initialization parameter

### 21.1.4.3 CPU-Related Initialization Parameters for PDBs

The `CPU_COUNT` initialization parameter specifies the number of CPUs available for Oracle Database to use.

*Instance caging* is a technique that uses an initialization parameter to limit the number of CPUs that an instance can use simultaneously. You can set `CPU_COUNT` at the PDB level. If Resource Manager is enabled, then the PDB is “caged” (restricted) to the number of CPUs specified by `CPU_COUNT`.

`CPU_COUNT` works the same way as the `utilization_limit` directive in the CDB plan. However, the `CPU_COUNT` limit is expressed in terms of number of CPUs rather than utilization percentage. If both the `utilization_limit` and `CPU_COUNT` are specified, then the lower limit is enforced.

`CPU_COUNT` is advantageous because when the PDB is plugged into a new container, the `CPU_COUNT` setting remains with the plugged-in PDB. Also, Oracle Database uses the `CPU_COUNT` setting for a PDB to derive many other PDB parameters, such as those for parallel execution.

## 21.2 Managing CDB Resource Plans

In a CDB, PDBs might have different levels of priority. You can create CDB resource plans to distribute resources to different PDBs based on these priorities.

This section contains the following topics:

- [About CDB Resource Plans](#)  
Create CDB resource plans that allocate shares and resource limits for PDBs.
- [Creating a CDB Resource Plan for Managing PDBs](#)  
To create a CDB resource plan for individual PDBs and define the directives for the plan, use the `DBMS_RESOURCE_MANAGER` package.
- [Creating a CDB Resource Plan for Managing PDBs: Scenario](#)  
This scenario illustrates each of the steps involved in creating a CDB resource plan for individual PDBs.
- [Creating a CDB Resource Plan with PDB Performance Profiles](#)  
Use the `DBMS_RESOURCE_MANAGER` package to create a CDB resource plan for PDB performance profiles and define the directives for the plan. Each PDB that uses a profile adopts the CDB resource plan directive.



- [Creating a CDB Resource Plan for PDB Performance Profiles: Scenario](#)  
This scenario illustrates the steps involved in creating a CDB resource plan for PDB performance profiles.
- [Enabling a CDB Resource Plan](#)  
You enable the Resource Manager for a CDB by setting the `RESOURCE_MANAGER_PLAN` initialization parameter in the root.
- [Modifying a CDB Resource Plan](#)  
Modifying a CDB resource plan includes tasks such as updating the plan, creating, updating, or deleting plan directives for PDBs, and updating default directives.
- [Disabling a CDB Resource Plan](#)  
Disable the Resource Manager for a CDB by unsetting the `RESOURCE_MANAGER_PLAN` initialization parameter in the CDB root.
- [Viewing Information About Plans and Directives in a CDB](#)  
You can view information about CDB resource plans, CDB resource plan directives, and predefined resource plans in a CDB.

## 21.2.1 About CDB Resource Plans

Create CDB resource plans that allocate shares and resource limits for PDBs.

This section contains the following topics:

- [Shares for Allocating Resources to PDBs](#)  
To allocate resources among PDBs, assign a share value to each PDB or performance profile. A higher share value results in more guaranteed resources for a PDB or the PDBs that use the performance profile.
- [Utilization Limits for PDBs](#)  
A utilization limit restrains the system resource usage of a specific PDB or a specific PDB performance profile.
- [The Default Directive for PDBs](#)  
When you do not explicitly define directives for a PDB, the PDB uses the default directive for PDBs.

### 21.2.1.1 Shares for Allocating Resources to PDBs

To allocate resources among PDBs, assign a share value to each PDB or performance profile. A higher share value results in more guaranteed resources for a PDB or the PDBs that use the performance profile.

Specify a share value for a PDB using the `DBMS_RESOURCE_MANAGER.CREATE_CDB_PLAN_DIRECTIVE` procedure and for a PDB performance profile using the `DBMS_RESOURCE_MANAGER.CREATE_CDB_PROFILE_DIRECTIVE` procedure. In both cases, the `shares` parameter specifies the share value for the PDB. Multiple PDBs can use the same PDB performance profile.

The following figure shows an example of three PDBs with share values specified for them in a CDB resource plan.

**Figure 21-1 Shares in a CDB Resource Plan**

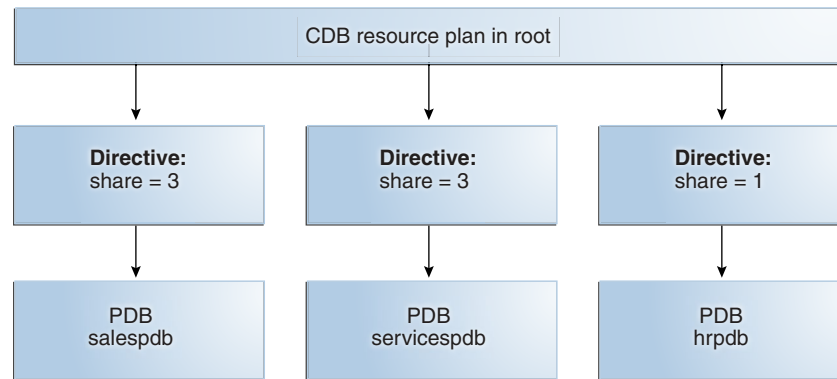

The preceding figure shows that the total number of shares is seven (3 plus 3 plus 1). The `salespdb` and the `servicespdb` PDB are each guaranteed 3/7 of the resources, while the `hrpdb` PDB is guaranteed 1/7 of the resources. However, any PDB can use more than the guaranteed amount of a resource when no resource contention exists.

The following table shows the resource allocation to the PDBs in the preceding figure based on the share values. The table assumes that loads of the PDBs consume all system resources allocated.

**Table 21-2 Resource Allocation for Sample PDBs**

Resource	Resource Allocation	See Also
CPU	The <code>salespdb</code> and <code>servicespdb</code> PDBs can consume the same amount of CPU resources. The <code>salespdb</code> and <code>servicespdb</code> PDBs are each guaranteed three times more CPU resource than the <code>hrpdb</code> PDB.	<i>Oracle Database Administrator's Guide</i> for more information about this resource
Parallel execution servers	Queued parallel queries from the <code>salespdb</code> and <code>servicespdb</code> PDBs are selected equally. Queued parallel queries from the <code>salespdb</code> and <code>servicespdb</code> PDBs are selected three times as often as queued parallel queries from the <code>hrpdb</code> PDB.	<i>Oracle Database Administrator's Guide</i> for more information about this resource

### 21.2.1.2 Utilization Limits for PDBs

A utilization limit restrains the system resource usage of a specific PDB or a specific PDB performance profile.

You can specify utilization limits for CPU and parallel execution servers. Utilization limits for a PDB are set by the CDB resource plan.

The following table describes utilization limits for PDBs and the Resource Manager action taken when a PDB reaches a utilization limit. For limits specified with a PDB performance profile, the limit applies to every PDB that uses the PDB performance

profile. For example, if `pdb1` and `pdb20` have a performance profile `BRONZE`, and if `BRONZE` has a limit set to 10%, then `pdb1` has a 10% limit and `pdb20` has a 10% limit.

**Table 21-3 Utilization Limits for PDBs**

Resource	Resource Utilization Limit	Resource Manager Action When Limit Is Reached
CPU	<p>The CPU utilization limit for sessions connected to a PDB is set by the <code>utilization_limit</code> parameter in subprograms of the <code>DBMS_RESOURCE_MANAGER</code> package. The <code>utilization_limit</code> parameter specifies the percentage of the system resources that a PDB can use. The value ranges from 0 to 100.</p> <p>You can also limit CPU for a PDB by setting the initialization parameter <code>CPU_COUNT</code>. For example, if you set the <code>CPU_COUNT</code> to 8, then the PDB cannot use more than 8 CPUs at any time. If both <code>utilization_limit</code> and <code>CPU_COUNT</code> are specified, then the more restrictive (lower) value is enforced.</p>	<p>Resource Manager throttles the PDB sessions so that the CPU utilization for the PDB does not exceed the utilization limit.</p>

**Table 21-3 (Cont.) Utilization Limits for PDBs**

Resource	Resource Utilization Limit	Resource Manager Action When Limit Is Reached
Parallel execution servers	<p>You can limit the number of parallel execution servers in a PDB by means of parallel statement queuing. The limit is a “queuing point” because the database queues parallel queries when the limit is reached.</p> <p>You can set the limit (queuing point) in either of the following ways:</p> <ul style="list-style-type: none"> <li>• The value of the <code>PARALLEL_SERVERS_TARGET</code> initialization parameter setting in the PDB</li> <li>• The value of the <code>PARALLEL_SERVERS_TARGET</code> initialization parameter setting in the CDB root multiplied by the value of the <code>parallel_server_limit</code> directive set for the PDB in the CDB resource manager plan</li> </ul> <p>For example, if the <code>PARALLEL_SERVERS_TARGET</code> initialization parameter is set to 200 in the CDB root, and if the <code>parallel_server_limit</code> directive for a PDB is set to 10%, then utilization limit for the PDB is 20 parallel execution servers (200 * .10).</p> <p>If the limit is set in both preceding ways, then the lower limit of the two is used. See <i>Oracle Database Reference</i> for the default value for <code>PARALLEL_SERVERS_TARGET</code>.</p> <p><b>Note:</b> Oracle recommends using the <code>PARALLEL_SERVERS_TARGET</code> initialization parameter instead of the <code>parallel_server_limit</code> directive in a CDB plan.</p>	<p>Resource Manager queues parallel queries when the number of parallel execution servers used by the PDB would exceed the limit.</p> <p><b>Note:</b> In a CDB, parallel statements are queued based on the <code>PARALLEL_SERVERS_TARGET</code> settings at both the PDB and CDB level. A statement is queued when the number of parallel servers used by the PDB exceeds the target for the PDB or when the number of parallel servers used by all PDBs exceeds the target for the CDB.</p>

The following figure shows an example of three PDBs with shares and utilization limits specified for them in a CDB resource plan.

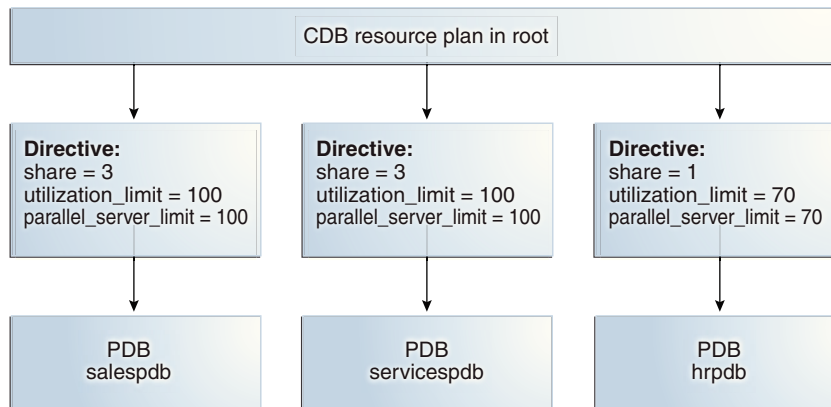
**Figure 21-2 Shares and Utilization Limits in a CDB Resource Plan**

The preceding figure shows that there are no utilization limits on the salespdb and servicespdb PDBs because utilization\_limit and parallel\_server\_limit are both set to 100% for them. However, the hrpdb PDB is limited to 70% of the applicable system resources because utilization\_limit and parallel\_server\_limit are both set to 70%.

**Note:**

This scenario assumes that the `PARALLEL_SERVERS_TARGET` initialization parameter does not specify a lower limit in a PDB. When the `PARALLEL_SERVERS_TARGET` initialization parameter specifies a lower limit for parallel execution servers in a PDB, the lower limit is used.

**See Also:**

- *Oracle Database Administrator's Guide*
- *Oracle Database Reference* to learn about `CPU_COUNT`

### 21.2.1.3 The Default Directive for PDBs

When you do not explicitly define directives for a PDB, the PDB uses the default directive for PDBs.

The following table shows the attributes of the initial default directive for PDBs.

**Table 21-4 Initial Default Directive Attributes for PDBs**

Directive Attribute	Value
shares	1
utilization_limit	100
parallel_server_limit	100

When a PDB is plugged into a CDB and no directive is defined for it, the PDB uses the default directive for PDBs.

You can create new directives for the new PDB. You can also change the default directive attribute values for PDBs by using the `UPDATE_CDB_DEFAULT_DIRECTIVE` procedure in the `DBMS_RESOURCE_MANAGER` package.

When a PDB is unplugged from a CDB, the directive for the PDB is retained. If the same PDB is plugged back into the CDB, then it uses the directive defined for it if the directive was not deleted manually.

Figure 21-3 shows an example of the default directive in a CDB resource plan.

**Figure 21-3 Default Directive in a CDB Resource Plan**

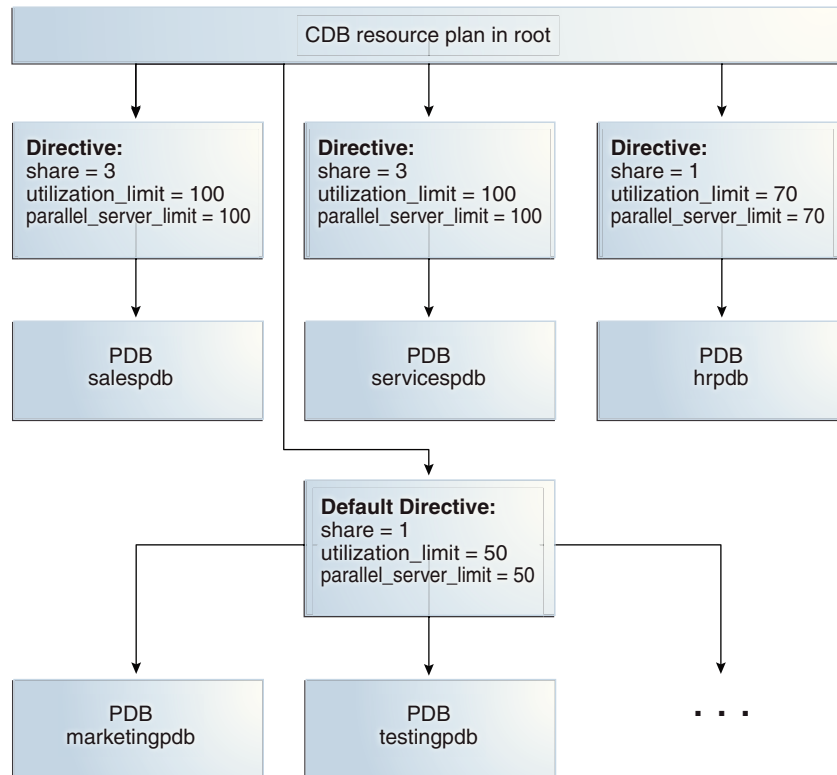

Figure 21-3 shows that the default PDB directive specifies that the `share` is 1, the `utilization_limit` is 50%, and the `parallel_server_limit` is 50%. Any PDB that is part of the CDB and does not have directives defined for it uses the default PDB

directive. [Figure 21-3](#) shows the PDBs `marketingpdb` and `testingpdb` using the default PDB directive. Therefore, `marketingpdb` and `testingpdb` each get 1 share and utilization limits of 50.

#### See Also:

- ["Creating New CDB Resource Plan Directives for a PDB"](#)
- ["Updating the Default Directive for PDBs in a CDB Resource Plan"](#)
- ["Creating and Removing PDBs and Application Containers"](#)
- ["Unplugging a PDB from a CDB"](#)
- *Oracle Database Administrator's Guide* for information about the parallel server limit

## 21.2.2 Creating a CDB Resource Plan for Managing PDBs

To create a CDB resource plan for individual PDBs and define the directives for the plan, use the `DBMS_RESOURCE_MANAGER` package.

The general steps for creating a CDB resource plan for individual PDBs are the following:

1. Create the pending area using the `CREATE_PENDING_AREA` procedure.
2. Create the CDB resource plan using the `CREATE_CDB_PLAN` procedure.
3. Create directives for the PDBs using the `CREATE_CDB_PLAN_DIRECTIVE` procedure.
4. (Optional) Update the default PDB directive using the `UPDATE_CDB_DEFAULT_DIRECTIVE` procedure.
5. Validate the pending area using the `VALIDATE_PENDING_AREA` procedure.
6. Submit the pending area using the `SUBMIT_PENDING_AREA` procedure.

## 21.2.3 Creating a CDB Resource Plan for Managing PDBs: Scenario

This scenario illustrates each of the steps involved in creating a CDB resource plan for individual PDBs.

The scenario assumes that you want to create a CDB resource plan for a CDB named `newcdb`. The plan includes a directive for each PDB. In this scenario, you also update the default directive and the `AutoTask` directive.

The directives are defined using various procedures in the `DBMS_RESOURCE_MANAGER` package. The attributes of each directive are defined using parameters in these procedures. [Table 21-5](#) describes the types of directives in the plan.

**Table 21-5 Attributes for PDB Directives in a CDB Resource Plan**

Directive Attribute	Description	See Also
shares	Resource allocation share for CPU and parallel execution server resources.	"Shares for Allocating Resources to PDBs"
utilization_limit	Resource utilization limit for CPU.	"Utilization Limits for PDBs"
parallel_server_limit	<p>Maximum percentage of parallel execution servers that a PDB can use before queuing parallel statements.</p> <p>When the <code>parallel_server_limit</code> directive is specified for a PDB, the limit is the <code>PARALLEL_SERVERS_TARGET</code> value of the CDB root multiplied by the value of the <code>parallel_server_limit</code> parameter in the <code>CREATE_CDB_PLAN_DIRECTIVE</code> procedure.</p> <p><b>Note:</b> Oracle recommends using the <code>PARALLEL_SERVERS_TARGET</code> initialization parameter instead of the <code>parallel_server_limit</code> directive in a CDB plan.</p>	"Utilization Limits for PDBs"

Table 21-6 describes how the CDB resource plan allocates resources to its PDBs using the directive attributes described in Table 21-5.

**Table 21-6 Sample Directives for PDBs in a CDB Resource Plan**

PDB	shares Directive	utilization_limit Directive	parallel_server_limit Directive
salespdb	3	Unlimited	Unlimited
servicespdb	3	Unlimited	Unlimited
hrpdb	1	70	70
Default	1	50	50
AutoTask	1	75	75

The `salespdb` and `servicespdb` PDBs are more important than the other PDBs in the CDB. Therefore, they get a higher share (3), unlimited CPU utilization resource, and unlimited parallel execution server resource.

The default directive applies to PDBs for which specific directives have not been defined. For this scenario, assume that the CDB has several PDBs that use the default directive. This scenario updates the default directive.



In addition, this scenario updates the AutoTask directive. The AutoTask directive applies to automatic maintenance tasks that are run in the root maintenance window.

**To create a CDB resource plan:**

1. Create a pending area using the `CREATE_PENDING_AREA` procedure:

```
exec DBMS_RESOURCE_MANAGER.CREATE_PENDING_AREA();
```

2. Create a CDB resource plan named `newcdb_plan` using the `CREATE_CDB_PLAN` procedure:

```
BEGIN
  DBMS_RESOURCE_MANAGER.CREATE_CDB_PLAN(
    plan      => 'newcdb_plan',
    comment => 'CDB resource plan for newcdb');
END;
/
```

3. Create the CDB resource plan directives for the PDBs using the `CREATE_CDB_PLAN_DIRECTIVE` procedure. Each directive specifies how resources are allocated to a specific PDB.

[Table 21-6](#) describes the directives for the `salespdb`, `servicespdb`, and `hrpdb` PDBs in this scenario. Run the following procedures to create these directives:

```
BEGIN
  DBMS_RESOURCE_MANAGER.CREATE_CDB_PLAN_DIRECTIVE(
    plan                => 'newcdb_plan',
    pluggable_database => 'salespdb',
    shares              => 3,
    utilization_limit   => 100,
    parallel_server_limit => 100);
END;
/
```

```
BEGIN
  DBMS_RESOURCE_MANAGER.CREATE_CDB_PLAN_DIRECTIVE(
    plan                => 'newcdb_plan',
    pluggable_database => 'servicespdb',
    shares              => 3,
    utilization_limit   => 100,
    parallel_server_limit => 100);
END;
/
```

```
BEGIN
  DBMS_RESOURCE_MANAGER.CREATE_CDB_PLAN_DIRECTIVE(
    plan                => 'newcdb_plan',
    pluggable_database => 'hrpdb',
    shares              => 1,
    utilization_limit   => 70,
    parallel_server_limit => 70);
END;
/
```

All other PDBs in this CDB use the default PDB directive.

4. If the current default CDB resource plan directive for PDBs does not meet your requirements, then update the directive using the `UPDATE_CDB_DEFAULT_DIRECTIVE` procedure.

The default directive applies to PDBs for which specific directives have not been defined. See "[The Default Directive for PDBs](#)" for more information.

[Table 21-6](#) describes the default directive that PDBs use in this scenario. Run the following procedure to update the default directive:

```
BEGIN
  DBMS_RESOURCE_MANAGER.UPDATE_CDB_DEFAULT_DIRECTIVE(
    plan                => 'newcdb_plan',
    new_shares          => 1,
    new_utilization_limit => 50,
    new_parallel_server_limit => 50);
END;
/
```

5. Validate the pending area using the `VALIDATE_PENDING_AREA` procedure:

```
exec DBMS_RESOURCE_MANAGER.VALIDATE_PENDING_AREA();
```

6. Submit the pending area using the `SUBMIT_PENDING_AREA` procedure:

```
exec DBMS_RESOURCE_MANAGER.SUBMIT_PENDING_AREA();
```

## 21.2.4 Creating a CDB Resource Plan with PDB Performance Profiles

Use the `DBMS_RESOURCE_MANAGER` package to create a CDB resource plan for PDB performance profiles and define the directives for the plan. Each PDB that uses a profile adopts the CDB resource plan directive.

The general steps for creating a CDB resource plan with PDB performance profiles are the following:

1. Create the pending area using the `CREATE_PENDING_AREA` procedure.
2. Create the CDB resource plan using the `CREATE_CDB_PLAN` procedure.
3. Create directives for the PDB performance profiles using the `CREATE_CDB_PROFILE_DIRECTIVE` procedure.
4. (Optional) Update the default PDB directive using the `UPDATE_CDB_DEFAULT_DIRECTIVE` procedure.
5. Validate the pending area using the `VALIDATE_PENDING_AREA` procedure.
6. Submit the pending area using the `SUBMIT_PENDING_AREA` procedure.
7. For each PDB that will use a profile, set the `DB_PERFORMANCE_PROFILE` initialization parameter and specify the profile name.

## 21.2.5 Creating a CDB Resource Plan for PDB Performance Profiles: Scenario

This scenario illustrates the steps involved in creating a CDB resource plan for PDB performance profiles.

The scenario assumes that you want to create a CDB resource plan for a CDB named `newcdb`. The plan includes a directive for each PDB performance profile. In this scenario, you also update the default directive and the `AutoTask` directive.

In the CDB resource plan, you give each profile a name. In each PDB, you set the `DB_PERFORMANCE_PROFILE` initialization parameter to specify which PDB performance profile the PDB uses.

The directives are defined using various procedures in the `DBMS_RESOURCE_MANAGER` package. The attributes of each directive are defined using parameters in these procedures. The following table describes the types of directives in the plan.

**Table 21-7 Attributes for PDB Performance Profile Directives in a CDB Resource Plan**

Directive Attribute	Description	See Also
<code>shares</code>	Resource allocation share for CPU and parallel execution server resources.	<a href="#">"Shares for Allocating Resources to PDBs"</a>
<code>utilization_limit</code>	Resource utilization limit for CPU.	<a href="#">"Utilization Limits for PDBs"</a>
<code>parallel_server_limit</code>	Maximum percentage of parallel execution servers that a PDB can use.  When the <code>parallel_server_limit</code> directive is specified for a PDB performance profile, the limit is the value of the <code>PARALLEL_SERVERS_TARGET</code> initialization parameter setting in the CDB root multiplied by the value of the <code>parallel_server_limit</code> parameter in the <code>CREATE_CDB_PROFILE_DIRECTIVE</code> procedure.	<a href="#">"Utilization Limits for PDBs"</a>

The following table describes how the CDB resource plan allocates resources to its PDB performance profiles using the directive attributes described in [Table 21-7](#).

**Table 21-8 Sample Directives for PDB Performance Profiles in a CDB Resource Plan**

PDB	<code>shares</code> Directive	<code>utilization_limit</code> Directive	<code>parallel_server_limit</code> Directive
<code>gold</code>	3	Unlimited	Unlimited

**Table 21-8 (Cont.) Sample Directives for PDB Performance Profiles in a CDB Resource Plan**

PDB	shares Directive	utilization_limit Directive	parallel_server_limit Directive
silver	2	40	40
bronze	1	20	20
Default	1	10	10
AutoTask	2	60	60

The default directive applies to PDBs for which specific directives have not been defined. For this scenario, assume that the CDB has several PDBs that use the default directive. This scenario updates the default directive.

In addition, this scenario updates the AutoTask directive. The AutoTask directive applies to automatic maintenance tasks that are run in the root maintenance window.

#### To create a CDB resource plan for PDB performance profiles:

1. For each PDB that will use a profile, set the `DB_PERFORMANCE_PROFILE` initialization parameter to the name of the profile that the PDB will use.

- a. Run an `ALTER SYSTEM` statement to set the parameter.

For example, with the PDB as the current container, run the following SQL statement:

```
ALTER SYSTEM SET DB_PERFORMANCE_PROFILE=gold SCOPE=spfile;
```

- b. Close the PDB:

```
ALTER PLUGGABLE DATABASE CLOSE IMMEDIATE;
```

- c. Open the PDB:

```
ALTER PLUGGABLE DATABASE OPEN;
```

2. Create a pending area using the `CREATE_PENDING_AREA` procedure:

```
exec DBMS_RESOURCE_MANAGER.CREATE_PENDING_AREA();
```

3. Create a CDB resource plan named `newcdb_plan` using the `CREATE_CDB_PLAN` procedure:

```
BEGIN
  DBMS_RESOURCE_MANAGER.CREATE_CDB_PLAN(
    plan    => 'newcdb_plan',
    comment => 'CDB resource plan for newcdb');
END;
/
```

4. Create the CDB resource plan directives for the PDBs using the `CREATE_CDB_PLAN_DIRECTIVE` procedure. Each directive specifies how resources are allocated to a specific PDB.

Table 21-6 describes the directives for the gold, silver, and bronze profiles in this scenario. Run the following procedures to create these directives:

```
BEGIN
  DBMS_RESOURCE_MANAGER.CREATE_CDB_PROFILE_DIRECTIVE(
    plan          => 'newcdb_plan',
    profile       => 'gold',
    shares        => 3,
    utilization_limit => 100,
    parallel_server_limit => 100);
END;
/

BEGIN
  DBMS_RESOURCE_MANAGER.CREATE_CDB_PROFILE_DIRECTIVE(
    plan          => 'newcdb_plan',
    profile       => 'silver',
    shares        => 2,
    utilization_limit => 40,
    parallel_server_limit => 40);
END;
/

BEGIN
  DBMS_RESOURCE_MANAGER.CREATE_CDB_PROFILE_DIRECTIVE(
    plan          => 'newcdb_plan',
    profile       => 'bronze',
    shares        => 1,
    utilization_limit => 20,
    parallel_server_limit => 20);
END;
/
```

All other PDBs in this CDB use the default PDB directive.

5. If the current default CDB resource plan directive for PDBs does not meet your requirements, then update the directive using the `UPDATE_CDB_DEFAULT_DIRECTIVE` procedure.

The default directive applies to PDBs for which specific directives have not been defined.

Table 21-6 describes the default directive that PDBs use in this scenario. Run the following procedure to update the default directive:

```
BEGIN
  DBMS_RESOURCE_MANAGER.UPDATE_CDB_DEFAULT_DIRECTIVE(
    plan          => 'newcdb_plan',
    new_shares    => 1,
    new_utilization_limit => 10,
    new_parallel_server_limit => 10);
END;
/
```

6. Validate the pending area using the `VALIDATE_PENDING_AREA` procedure:

```
exec DBMS_RESOURCE_MANAGER.VALIDATE_PENDING_AREA();
```

7. Submit the pending area using the `SUBMIT_PENDING_AREA` procedure:

```
exec DBMS_RESOURCE_MANAGER.SUBMIT_PENDING_AREA();
```

**See Also:**

["The Default Directive for PDBs"](#)

## 21.2.6 Enabling a CDB Resource Plan

You enable the Resource Manager for a CDB by setting the `RESOURCE_MANAGER_PLAN` initialization parameter in the root.

This parameter specifies the top plan, which is the plan to be used for the current CDB instance. If no plan is specified with this parameter, then the Resource Manager is not enabled.

### Prerequisites

Before enabling a CDB resource plan, complete the prerequisites described in ["Overview of Oracle Resource Manager in a Multitenant Environment"](#).

### To enable a CDB resource plan:

1. In SQL\*Plus, ensure that the current container is the root.
2. Perform one of the following actions:
  - Use an `ALTER SYSTEM` statement to set the `RESOURCE_MANAGER_PLAN` initialization parameter to the CDB resource plan.

The following example sets the CDB resource plan to `newcdb_plan` using an `ALTER SYSTEM` statement:

```
ALTER SYSTEM SET RESOURCE_MANAGER_PLAN = 'newcdb_plan';
```

- In a text initialization parameter file, set the `RESOURCE_MANAGER_PLAN` initialization parameter to the CDB resource plan, and restart the CDB.

The following example sets the CDB resource plan to `newcdb_plan` in an initialization parameter file:

```
RESOURCE_MANAGER_PLAN = 'newcdb_plan'
```

 **See Also:**

- ["About Container Access in a CDB"](#)
- *Oracle Database Administrator's Guide* to learn how to schedule a CDB resource plan change with Oracle Scheduler

## 21.2.7 Modifying a CDB Resource Plan

Modifying a CDB resource plan includes tasks such as updating the plan, creating, updating, or deleting plan directives for PDBs, and updating default directives.

This section contains the following topics:

- [Updating a CDB Resource Plan](#)  
You can update a CDB resource plan to change its comment using the `UPDATE_CDB_PLAN` procedure.
- [Managing CDB Resource Plan Directives for a PDB](#)  
You can create, update, and delete CDB resource plan directives for a PDB.
- [Managing CDB Resource Plan Directives for a PDB Performance Profile](#)  
You can create, update, and delete CDB resource plan directives for a PDB performance profile.
- [Updating the Default Directive for PDBs in a CDB Resource Plan](#)  
You can update the default directive for PDBs in a CDB resource plan using the `UPDATE_CDB_DEFAULT_DIRECTIVE` procedure. The default directive applies to PDBs for which specific directives have not been defined.
- [Updating the Default Directive for Maintenance Tasks in a CDB Resource Plan](#)  
You can update the AutoTask directive in a CDB resource plan using the `UPDATE_CDB_AUTOTASK_DIRECTIVE` procedure. The AutoTask directive applies to automatic maintenance tasks that are run in the root maintenance window.
- [Deleting a CDB Resource Plan](#)  
You can delete a CDB resource plan using the `DELETE_CDB_PLAN` procedure.

### 21.2.7.1 Updating a CDB Resource Plan

You can update a CDB resource plan to change its comment using the `UPDATE_CDB_PLAN` procedure.

#### Prerequisites

Before updating a CDB resource plan, complete the prerequisites described in ["Overview of Oracle Resource Manager in a Multitenant Environment"](#).

#### To update a CDB resource plan:

1. In SQL\*Plus, ensure that the current container is the root.
2. Create a pending area:

```
exec DBMS_RESOURCE_MANAGER.CREATE_PENDING_AREA();
```

3. Run the `UPDATE_CDB_PLAN` procedure, and enter a new comment in the `new_comment` parameter.

For example, the following procedure changes the comment for the `newcdb_plan` CDB resource plan:

```
BEGIN
  DBMS_RESOURCE_MANAGER.UPDATE_CDB_PLAN(
    plan          => 'newcdb_plan',
    new_comment => 'CDB plan for PDBs in newcdb');
END;
/
```

4. Validate the pending area:

```
exec DBMS_RESOURCE_MANAGER.VALIDATE_PENDING_AREA();
```

5. Submit the pending area:

```
exec DBMS_RESOURCE_MANAGER.SUBMIT_PENDING_AREA();
```

#### See Also:

- ["About CDB Resource Plans"](#)
- ["About Container Access in a CDB"](#)

## 21.2.7.2 Managing CDB Resource Plan Directives for a PDB

You can create, update, and delete CDB resource plan directives for a PDB.

This section contains the following topics:

- [Creating New CDB Resource Plan Directives for a PDB](#)  
When you create a PDB in a CDB, you can create a CDB resource plan directive for the PDB using the `CREATE_CDB_PLAN_DIRECTIVE` procedure. The directive specifies how resources are allocated to the new PDB.
- [Updating CDB Resource Plan Directives for a PDB](#)  
You can update the CDB resource plan directive for a PDB using the `UPDATE_CDB_PLAN_DIRECTIVE` procedure. The directive specifies how resources are allocated to the PDB.
- [Deleting CDB Resource Plan Directives for a PDB](#)  
You can delete the CDB resource plan directive for a PDB using the `DELETE_CDB_PLAN_DIRECTIVE` procedure.



### 21.2.7.2.1 Creating New CDB Resource Plan Directives for a PDB

When you create a PDB in a CDB, you can create a CDB resource plan directive for the PDB using the `CREATE_CDB_PLAN_DIRECTIVE` procedure. The directive specifies how resources are allocated to the new PDB.

#### Prerequisites

Before creating a new CDB resource plan directive for a PDB, complete the prerequisites described in "[Overview of Oracle Resource Manager in a Multitenant Environment](#)".

#### To create a new CDB resource plan directive for a PDB:

1. In SQL\*Plus, ensure that the current container is the root.
2. Create a pending area:

```
exec DBMS_RESOURCE_MANAGER.CREATE_PENDING_AREA();
```

3. Run the `CREATE_CDB_PLAN_DIRECTIVE` procedure, and specify the appropriate values for the new PDB.

For example, the following procedure allocates resources to a PDB named `operpdb` in the `newcdb_plan` CDB resource plan:

```
BEGIN
  DBMS_RESOURCE_MANAGER.CREATE_CDB_PLAN_DIRECTIVE(
    plan                => 'newcdb_plan',
    pluggable_database  => 'operpdb',
    shares              => 1,
    utilization_limit   => 20,
    parallel_server_limit => 30);
END;
/
```

4. Validate the pending area:

```
exec DBMS_RESOURCE_MANAGER.VALIDATE_PENDING_AREA();
```

5. Submit the pending area:

```
exec DBMS_RESOURCE_MANAGER.SUBMIT_PENDING_AREA();
```



#### See Also:

- "[About CDB Resource Plans](#)"
- "[About Container Access in a CDB](#)"

## 21.2.7.2.2 Updating CDB Resource Plan Directives for a PDB

You can update the CDB resource plan directive for a PDB using the `UPDATE_CDB_PLAN_DIRECTIVE` procedure. The directive specifies how resources are allocated to the PDB.

### Prerequisites

Before updating a CDB resource plan directive for a PDB, ensure that you meet the prerequisites described in "[Overview of Oracle Resource Manager in a Multitenant Environment](#)".

### To update a CDB resource plan directive for a PDB:

1. In SQL\*Plus, ensure that the current container is the root.
2. Create a pending area:

```
exec DBMS_RESOURCE_MANAGER.CREATE_PENDING_AREA();
```

3. Run the `UPDATE_CDB_PLAN_DIRECTIVE` procedure, and specify the new resource allocation values for the PDB.

For example, the following procedure updates the resource allocation to a PDB named `operpdb` in the `newcdb_plan` CDB resource plan:

```
BEGIN
  DBMS_RESOURCE_MANAGER.UPDATE_CDB_PLAN_DIRECTIVE(
    plan                => 'newcdb_plan',
    pluggable_database  => 'operpdb',
    new_shares          => 1,
    new_utilization_limit => 10,
    new_parallel_server_limit => 20);
END;
/
```

4. Validate the pending area:

```
exec DBMS_RESOURCE_MANAGER.VALIDATE_PENDING_AREA();
```

5. Submit the pending area:

```
exec DBMS_RESOURCE_MANAGER.SUBMIT_PENDING_AREA();
```

### See Also:

- ["About Container Access in a CDB"](#)
- ["About CDB Resource Plans"](#)

### 21.2.7.2.3 Deleting CDB Resource Plan Directives for a PDB

You can delete the CDB resource plan directive for a PDB using the `DELETE_CDB_PLAN_DIRECTIVE` procedure.

You might delete the directive for a PDB if you unplug or drop the PDB. However, you can retain the directive, and if the PDB is plugged into the CDB in the future, the existing directive applies to the PDB.

#### Prerequisites

Before deleting a CDB resource plan directive for a PDB, complete the prerequisites described in "[Overview of Oracle Resource Manager in a Multitenant Environment](#)".

#### To delete a CDB resource plan directive for a PDB:

1. In SQL\*Plus, ensure that the current container is the root.
2. Create a pending area:

```
exec DBMS_RESOURCE_MANAGER.CREATE_PENDING_AREA();
```

3. Run the `DELETE_CDB_PLAN_DIRECTIVE` procedure, and specify the CDB resource plan and the PDB.

For example, the following procedure deletes the directive for a PDB named `operpdb` in the `newcdb_plan` CDB resource plan:

```
BEGIN
  DBMS_RESOURCE_MANAGER.DELETE_CDB_PLAN_DIRECTIVE(
    plan          => 'newcdb_plan',
    pluggable_database => 'operpdb');
END;
/
```

4. Validate the pending area:

```
exec DBMS_RESOURCE_MANAGER.VALIDATE_PENDING_AREA();
```

5. Submit the pending area:

```
exec DBMS_RESOURCE_MANAGER.SUBMIT_PENDING_AREA();
```

#### See Also:

- "[About Container Access in a CDB](#)"
- "[About CDB Resource Plans](#)"

## 21.2.7.3 Managing CDB Resource Plan Directives for a PDB Performance Profile

You can create, update, and delete CDB resource plan directives for a PDB performance profile.

This section contains the following topics:

- [Creating New CDB Resource Plan Directives for a PDB Performance Profile](#)  
You can create a CDB resource plan directive for the a new PDB performance profile using the `CREATE_CDB_PROFILE_DIRECTIVE` procedure. The directive specifies how resources are allocated to the all PDBs that use the new profile.
- [Updating CDB Resource Plan Directives for a PDB Performance Profile](#)  
Update the CDB resource plan directive for a PDB performance profile using the `UPDATE_CDB_PROFILE_DIRECTIVE` procedure. The directive specifies how resources are allocated to the PDBs that use the PDB performance profile.
- [Deleting CDB Resource Plan Directives for a PDB Performance Profile](#)  
You can delete the CDB resource plan directive for a PDB performance profile using the `DELETE_CDB_PROFILE_DIRECTIVE` procedure.

### 21.2.7.3.1 Creating New CDB Resource Plan Directives for a PDB Performance Profile

You can create a CDB resource plan directive for the a new PDB performance profile using the `CREATE_CDB_PROFILE_DIRECTIVE` procedure. The directive specifies how resources are allocated to the all PDBs that use the new profile.

#### Prerequisites

Before creating a new CDB resource plan directive for a PDB performance profile, complete the prerequisites described in "[Overview of Oracle Resource Manager in a Multitenant Environment](#)".

**To create a new CDB resource plan directive for a PDB performance profile:**

1. In SQL\*Plus, ensure that the current container is the root.
2. Create a pending area:

```
exec DBMS_RESOURCE_MANAGER.CREATE_PENDING_AREA();
```

3. Run the `CREATE_CDB_PROFILE_DIRECTIVE` procedure, and specify the appropriate values for the new PDB performance profile.

For example, the following procedure allocates resources to a PDB performance profile named `copper` in the `newcdb_plan` CDB resource plan:

```
BEGIN
  DBMS_RESOURCE_MANAGER.CREATE_CDB_PROFILE_DIRECTIVE(
    plan           => 'newcdb_plan',
    profile        => 'copper',
    shares         => 1,
    utilization_limit => 20,
    parallel_server_limit => 30);
```

```
END;
/
```

#### 4. Validate the pending area:

```
exec DBMS_RESOURCE_MANAGER.VALIDATE_PENDING_AREA();
```

#### 5. Submit the pending area:

```
exec DBMS_RESOURCE_MANAGER.SUBMIT_PENDING_AREA();
```



#### Note:

For a PDB to use the new profile, the PDB must have the `DB_PERFORMANCE_PROFILE` initialization parameter set to the profile name.



#### See Also:

- ["About CDB Resource Plans"](#)
- ["About Container Access in a CDB"](#)

### 21.2.7.3.2 Updating CDB Resource Plan Directives for a PDB Performance Profile

Update the CDB resource plan directive for a PDB performance profile using the `UPDATE_CDB_PROFILE_DIRECTIVE` procedure. The directive specifies how resources are allocated to the PDBs that use the PDB performance profile.

Before updating a CDB resource plan directive for a PDB performance profile, complete the prerequisites described in ["Overview of Oracle Resource Manager in a Multitenant Environment"](#).

#### To update a CDB resource plan directive for a PDB performance profile:

1. In SQL\*Plus, ensure that the current container is the root.
2. Create a pending area:

```
exec DBMS_RESOURCE_MANAGER.CREATE_PENDING_AREA();
```

3. Run the `UPDATE_CDB_PROFILE_DIRECTIVE` procedure, and specify the new resource allocation values for the PDB performance profile.

For example, the following procedure updates the resource allocation for a PDB performance profile named `copper` in the `newcdb_plan` CDB resource plan:

```
BEGIN
  DBMS_RESOURCE_MANAGER.UPDATE_CDB_PROFILE_DIRECTIVE(
    plan          => 'newcdb_plan',
    profile       => 'copper',
```

```

        new_shares          => 1,
        new_utilization_limit => 10,
        new_parallel_server_limit => 20);
END;
/

```

#### 4. Validate the pending area:

```
exec DBMS_RESOURCE_MANAGER.VALIDATE_PENDING_AREA();
```

#### 5. Submit the pending area:

```
exec DBMS_RESOURCE_MANAGER.SUBMIT_PENDING_AREA();
```

#### See Also:

- ["About CDB Resource Plans"](#)
- ["About Container Access in a CDB"](#)

### 21.2.7.3.3 Deleting CDB Resource Plan Directives for a PDB Performance Profile

You can delete the CDB resource plan directive for a PDB performance profile using the `DELETE_CDB_PROFILE_DIRECTIVE` procedure.

If no PDBs use a performance profile, then you might delete the directive for the profile.

#### Prerequisites

Before deleting a CDB resource plan directive for a PDB performance profile, complete the prerequisites described in ["Overview of Oracle Resource Manager in a Multitenant Environment"](#).

#### To delete a CDB resource plan directive for a PDB performance profile:

1. In SQL\*Plus, ensure that the current container is the root.
2. Create a pending area:

```
exec DBMS_RESOURCE_MANAGER.CREATE_PENDING_AREA();
```

3. Run the `DELETE_CDB_PROFILE_DIRECTIVE` procedure, and specify the CDB resource plan and the PDB performance profile.

For example, the following procedure deletes the directive for a PDB named `operpdb` in the `newcdb_plan` CDB resource plan:

```

BEGIN
  DBMS_RESOURCE_MANAGER.DELETE_CDB_PLAN_DIRECTIVE(
    plan      => 'newcdb_plan',
    profile   => 'operpdb');

```

```
END;  
/
```

4. Validate the pending area:

```
exec DBMS_RESOURCE_MANAGER.VALIDATE_PENDING_AREA();
```

5. Submit the pending area:

```
exec DBMS_RESOURCE_MANAGER.SUBMIT_PENDING_AREA();
```

 See Also:

- ["About Container Access in a CDB"](#).
- ["About CDB Resource Plans"](#)

## 21.2.7.4 Updating the Default Directive for PDBs in a CDB Resource Plan

You can update the default directive for PDBs in a CDB resource plan using the `UPDATE_CDB_DEFAULT_DIRECTIVE` procedure. The default directive applies to PDBs for which specific directives have not been defined.

### Prerequisites

Before updating the default directive for PDBs in a CDB resource plan, complete the prerequisites described in ["Overview of Oracle Resource Manager in a Multitenant Environment"](#).

### To update the default directive for PDBs in a CDB resource plan:

1. In SQL\*Plus, ensure that the current container is the root.
2. Create a pending area:

```
exec DBMS_RESOURCE_MANAGER.CREATE_PENDING_AREA();
```

3. Run the `UPDATE_CDB_DEFAULT_DIRECTIVE` procedure, and specify the appropriate default resource allocation values.

For example, the following procedure updates the default directive for PDBs in the `newcdb_plan` CDB resource plan:

```
BEGIN  
  DBMS_RESOURCE_MANAGER.UPDATE_CDB_DEFAULT_DIRECTIVE(  
    plan           => 'newcdb_plan',  
    new_shares     => 2,  
    new_utilization_limit => 40);  
END;  
/
```

**4. Validate the pending area:**

```
exec DBMS_RESOURCE_MANAGER.VALIDATE_PENDING_AREA();
```

**5. Submit the pending area:**

```
exec DBMS_RESOURCE_MANAGER.SUBMIT_PENDING_AREA();
```

 **See Also:**

- See ["The Default Directive for PDBs"](#) for more information.
- ["About CDB Resource Plans"](#)
- See ["About Container Access in a CDB"](#).

## 21.2.7.5 Updating the Default Directive for Maintenance Tasks in a CDB Resource Plan

You can update the AutoTask directive in a CDB resource plan using the `UPDATE_CDB_AUTOTASK_DIRECTIVE` procedure. The AutoTask directive applies to automatic maintenance tasks that are run in the root maintenance window.

**Prerequisites**

Before updating the default directive for maintenance tasks in a CDB resource plan, complete the prerequisites described in ["Overview of Oracle Resource Manager in a Multitenant Environment"](#).

**To update the AutoTask directive for maintenance tasks in a CDB resource plan:**

1. In SQL\*Plus, ensure that the current container is the root.
2. Create a pending area:

```
exec DBMS_RESOURCE_MANAGER.CREATE_PENDING_AREA();
```

3. Run the `UPDATE_CDB_AUTOTASK_DIRECTIVE` procedure, and specify the appropriate AutoTask resource allocation values.

For example, the following procedure updates the AutoTask directive for maintenance tasks in the `newcdb_plan` CDB resource plan:

```
BEGIN
  DBMS_RESOURCE_MANAGER.UPDATE_CDB_AUTOTASK_DIRECTIVE(
    plan          => 'newcdb_plan',
    new_shares    => 2,
    new_utilization_limit => 60);
END;
/
```



**4. Validate the pending area:**

```
exec DBMS_RESOURCE_MANAGER.VALIDATE_PENDING_AREA();
```

**5. Submit the pending area:**

```
exec DBMS_RESOURCE_MANAGER.SUBMIT_PENDING_AREA();
```

 **See Also:**

- ["About Container Access in a CDB"](#)
- ["About CDB Resource Plans"](#)

## 21.2.7.6 Deleting a CDB Resource Plan

You can delete a CDB resource plan using the `DELETE_CDB_PLAN` procedure.

The resource plan must be disabled. You might delete a CDB resource plan if the plan is no longer needed. You can enable a different CDB resource plan, or you can disable Resource Manager for the CDB.

**Prerequisites**

Before deleting a CDB resource plan, complete the prerequisites described in ["Overview of Oracle Resource Manager in a Multitenant Environment"](#).

**To delete a CDB resource plan:**

1. In SQL\*Plus, ensure that the current container is the root.
2. Create a pending area:

```
exec DBMS_RESOURCE_MANAGER.CREATE_PENDING_AREA();
```

3. Run the `DELETE_CDB_PLAN` procedure, and specify the CDB resource plan.

For example, the following procedure deletes the `newcdb_plan` CDB resource plan:

```
BEGIN
  DBMS_RESOURCE_MANAGER.DELETE_CDB_PLAN(
    plan => 'newcdb_plan');
END;
/
```

4. Validate the pending area:

```
exec DBMS_RESOURCE_MANAGER.VALIDATE_PENDING_AREA();
```

5. Submit the pending area:

```
exec DBMS_RESOURCE_MANAGER.SUBMIT_PENDING_AREA();
```

 **See Also:**

- ["About CDB Resource Plans"](#)
- See ["About Container Access in a CDB"](#).
- ["Enabling a CDB Resource Plan"](#)
- ["Disabling a CDB Resource Plan"](#)

## 21.2.8 Disabling a CDB Resource Plan

Disable the Resource Manager for a CDB by unsetting the `RESOURCE_MANAGER_PLAN` initialization parameter in the CDB root.

A CDB resource plan that specifies shares or utilization limits for PDBs is required to enable CPU management, both between PDBs and within a PDB. If a resource plan with shares or utilization limits is enabled for a PDB, and if the CDB resource plan is not specified, then the CDB resource plan is set to `DEFAULT_CDB_PLAN`. This setting gives equal shares to all PDBs and specifies no utilization limits. To disable CPU resource management throughout the CDB, set `RESOURCE_MANAGER_PLAN` to `ORA$INTERNAL_CDB_PLAN`.

### Prerequisites

Before disabling a CDB resource plan, complete the prerequisites described in ["Overview of Oracle Resource Manager in a Multitenant Environment"](#).

### To disable a CDB resource plan:

1. In SQL\*Plus, ensure that the current container is the root.
2. Perform one of the following actions:
  - Use an `ALTER SYSTEM` statement to unset the `RESOURCE_MANAGER_PLAN` initialization parameter for the CDB.

The following example unsets the `RESOURCE_MANAGER_PLAN` initialization parameter using an `ALTER SYSTEM` statement:

```
ALTER SYSTEM SET RESOURCE_MANAGER_PLAN = '';
```

- In an initialization parameter file, unset the `RESOURCE_MANAGER_PLAN` initialization parameter, and restart the CDB.

The following example unsets the `RESOURCE_MANAGER_PLAN` initialization parameter in an initialization parameter file:

```
RESOURCE_MANAGER_PLAN =
```

 **See Also:**

- ["About Container Access in a CDB"](#)
- ["Shutting Down a CDB Instance"](#)
- *Oracle Database Administrator's Guide* for information about starting up a database

## 21.2.9 Viewing Information About Plans and Directives in a CDB

You can view information about CDB resource plans, CDB resource plan directives, and predefined resource plans in a CDB.

This section contains the following topics:

- [Viewing CDB Resource Plans](#)  
An example illustrates using the `DBA_CDB_RSRC_PLANS` view to display all CDB resource plans defined in the CDB.
- [Viewing CDB Resource Plan Directives](#)  
An example illustrates using the `DBA_CDB_RSRC_PLAN_DIRECTIVES` view to display all directives defined in all CDB resource plans in the CDB.

 **See Also:**

*Oracle Database Administrator's Guide* for information about monitoring Oracle Database Resource Manager

### 21.2.9.1 Viewing CDB Resource Plans

An example illustrates using the `DBA_CDB_RSRC_PLANS` view to display all CDB resource plans defined in the CDB.

The `DEFAULT_CDB_PLAN` is a default CDB plan that is supplied with Oracle Database. You can use this default plan if it meets your requirements.

**To view CDB resource plans:**

1. Start SQL\*Plus or SQL Developer, and log in to the CDB root.
2. Run the following query:

```
COLUMN PLAN FORMAT A30
COLUMN STATUS FORMAT A10
COLUMN COMMENTS FORMAT A35

SELECT PLAN, STATUS, COMMENTS
FROM   DBA_CDB_RSRC_PLANS
ORDER BY PLAN;
```

Your output looks similar to the following:

PLAN	STATUS	COMMENTS
DEFAULT_CDB_PLAN		Default CDB plan
DEFAULT_MAINTENANCE_PLAN		Default CDB maintenance plan
NEWCDB_PLAN		CDB plan for PDBs in newcdb
ORA\$INTERNAL_CDB_PLAN		Internal CDB plan

 **Note:**

Plans in the pending area have a status of `PENDING`. Plans in the pending area are being edited. Any plan that is not in the pending area has a `NULL` status.

 **See Also:**

["About CDB Resource Plans"](#)

## 21.2.9.2 Viewing CDB Resource Plan Directives

An example illustrates using the `DBA_CDB_RSRC_PLAN_DIRECTIVES` view to display all directives defined in all CDB resource plans in the CDB.

The `DEFAULT_CDB_PLAN` is a default CDB plan that is supplied with Oracle Database. With `DEFAULT_CDB_PLAN`, every PDB has 1 share and a utilization limit of 100. You can use this default plan if it meets your requirements. Note that `ORA$DEFAULT_PDB_DIRECTIVE` is the default directive for PDBs.

**To view CDB resource plan directives:**

1. Start SQL\*Plus or SQL Developer, and log in to the CDB root.
2. Run the following query:

```
COLUMN PLAN HEADING 'Plan' FORMAT A24
COLUMN PLUGGABLE_DATABASE HEADING 'Pluggable Database' FORMAT A25
COLUMN SHARES HEADING 'Shares' FORMAT 999
COLUMN UTILIZATION_LIMIT HEADING 'Utilization|Limit' FORMAT 999
COLUMN PARALLEL_SERVER_LIMIT HEADING 'Parallel|Server|Limit' FORMAT 999

SELECT PLAN,
       PLUGGABLE_DATABASE,
       SHARES,
       UTILIZATION_LIMIT,
       PARALLEL_SERVER_LIMIT
```

```
FROM DBA_CDB_RSRC_PLAN_DIRECTIVES
ORDER BY PLAN;
```

Your output looks similar to the following:

```
Parallel
Server
Plan          Pluggable Database      Utilization
Limit    Limit
-----
DEFAULT_CDB_PLAN          ORA$DEFAULT_PDB_DIRECTIVE      1
100      100
DEFAULT_CDB_PLAN          ORA$AUTOTASK
90       100
DEFAULT_MAINTENANCE_PLAN  ORA$AUTOTASK
90       100
DEFAULT_MAINTENANCE_PLAN  ORA$DEFAULT_PDB_DIRECTIVE      1
100      100
NEWCDB_PLAN              HRPDB                          1
70       70
NEWCDB_PLAN              SALESPDB                       3
100      100
NEWCDB_PLAN              ORA$DEFAULT_PDB_DIRECTIVE      1
50       50
NEWCDB_PLAN              ORA$AUTOTASK                   1
75       75
NEWCDB_PLAN              SERVICESPDB                    3
100      100
```

The preceding output shows the directives for the `newcdb_plan` created in "Creating a CDB Resource Plan for Managing PDBs: Scenario" and modified in "Modifying a CDB Resource Plan".

#### See Also:

- ["About CDB Resource Plans"](#)
- ["The Default Directive for PDBs"](#)

## 21.3 Managing PDB Resource Plans

You can create, enable, and modify resource plans for individual PDBs.

This section contains the following topics:

- [About PDB Resource Plans](#)  
A PDB resource plan determines how the resources for a specific PDB are allocated to consumer groups within this PDB.

- [Creating a PDB Resource Plan](#)  
You create a PDB resource plan in the same way that you create a resource plan for a non-CDB. You use procedures in the `DBMS_RESOURCE_MANAGER` PL/SQL package to create the plan.
- [Enabling a PDB Resource Plan](#)  
Enable a PDB resource plan by setting the `RESOURCE_MANAGER_PLAN` initialization parameter to the plan with an `ALTER SYSTEM` statement when the current container is the PDB.
- [Modifying a PDB Resource Plan](#)  
You can use the `DBMS_RESOURCE_MANAGER` package to modify a PDB resource plan in the same way you would modify the resource plan for a non-CDB.
- [Disabling a PDB Resource Plan](#)  
You disable a PDB resource plan by unsetting the `RESOURCE_MANAGER_PLAN` initialization parameter in the PDB.

### 21.3.1 About PDB Resource Plans

A PDB resource plan determines how the resources for a specific PDB are allocated to consumer groups within this PDB.

A PDB resource plan is similar to a resource plan for a non-CDB. A PDB resource plan differs from a CDB resource plan, which determines the amount of resources allocated to each PDB.

In a CDB, the following restrictions apply to PDB resource plans:

- A PDB resource plan cannot have subplans.
- A PDB resource plan can have a maximum of eight consumer groups.
- A PDB resource plan cannot have a multiple-level scheduling policy.

If you create a PDB using a non-CDB, and the non-CDB contains resource plans, then these resource plans might not conform to the preceding restrictions. In this case, Oracle Database automatically transforms these resource plans into equivalent PDB resource plans that meet these requirements. The original resource plans and directives are recorded in the `DBA_RSRC_PLANS` and `DBA_RSRC_PLAN_DIRECTIVES` views with the `LEGACY` status.

This section contains the following topics:

- [CDB Resource Plan Requirements When Creating PDB Resource Plans](#)  
When you create PDB resource plans, the CDB resource plan must meet certain requirements.
- [PDB Resource Plan: Example](#)  
A one-to-many relationship exists between CDB resource plans and PDB resource plans.

 **See Also:**

- ["About CDB Resource Plans"](#)
- ["Options for Creating a PDB from a Non-CDB"](#)
- *Oracle Database Administrator's Guide* to learn more about resource plans

### 21.3.1.1 CDB Resource Plan Requirements When Creating PDB Resource Plans

When you create PDB resource plans, the CDB resource plan must meet certain requirements.

Create directives for a CDB resource plan by using the `DBMS_RESOURCE_MANAGER.CREATE_CDB_PLAN_DIRECTIVE` procedure. Create directives for a PDB resource plan using the `CREATE_PLAN_DIRECTIVE` procedure in the same package. When you create one or more PDB resource plans and there is no CDB resource plan, the CDB uses the `DEFAULT_CDB_PLAN` that is supplied with Oracle Database.

The following table describes the requirements for the CDB resource plan and the results when the requirements are not met. The parameter values described in the "CDB Resource Plan Requirements" column are for the `CREATE_CDB_PLAN_DIRECTIVE` procedure. The parameter values described in the "Results When Requirements Are Not Met" column are for the `CREATE_PLAN_DIRECTIVE` procedure.

**Table 21-9 CDB Resource Plan Requirements for PDB Resource Plans**

Resource	CDB Resource Plan Requirements	Results When Requirements Are Not Met
CPU	<p>One of the following requirements must be met:</p> <ul style="list-style-type: none"> <li>• A share value must be specified for the PDB using the <code>shares</code> parameter.</li> <li>• A utilization limit for CPU below 100 must be specified for the PDB using the <code>utilization_limit</code> parameter.</li> </ul> <p>These values can be set in a directive for the specific PDB or in a default directive.</p>	<p>The CPU allocation policy of the PDB resource plan is not enforced.</p> <p>The CPU limit specified by the <code>utilization_limit</code> parameter in the PDB resource plan is not enforced.</p>
Parallel execution servers	<p>One of the following requirements must be met:</p> <ul style="list-style-type: none"> <li>• A share value must be specified for the PDB using the <code>shares</code> parameter.</li> <li>• A parallel server limit below 100 must be specified for the PDB using the <code>parallel_server_limit</code> parameter.</li> </ul> <p>These values can be set in a directive for the specific PDB or in a default directive.</p>	<p>The parallel execution server allocation policy of the PDB resource plan is not enforced.</p> <p>The parallel server limit specified by <code>parallel_server_limit</code> in the PDB resource plan is not enforced. However, you can set the <code>PARALLEL_SERVERS_TARGET</code> initialization parameter in a PDB to enforce the parallel limit.</p>

### 21.3.1.2 PDB Resource Plan: Example

A one-to-many relationship exists between CDB resource plans and PDB resource plans.

The following figure shows an example of a CDB resource plan and a PDB resource plan.

**Figure 21-4 A CDB Resource Plan and a PDB Resource Plan**

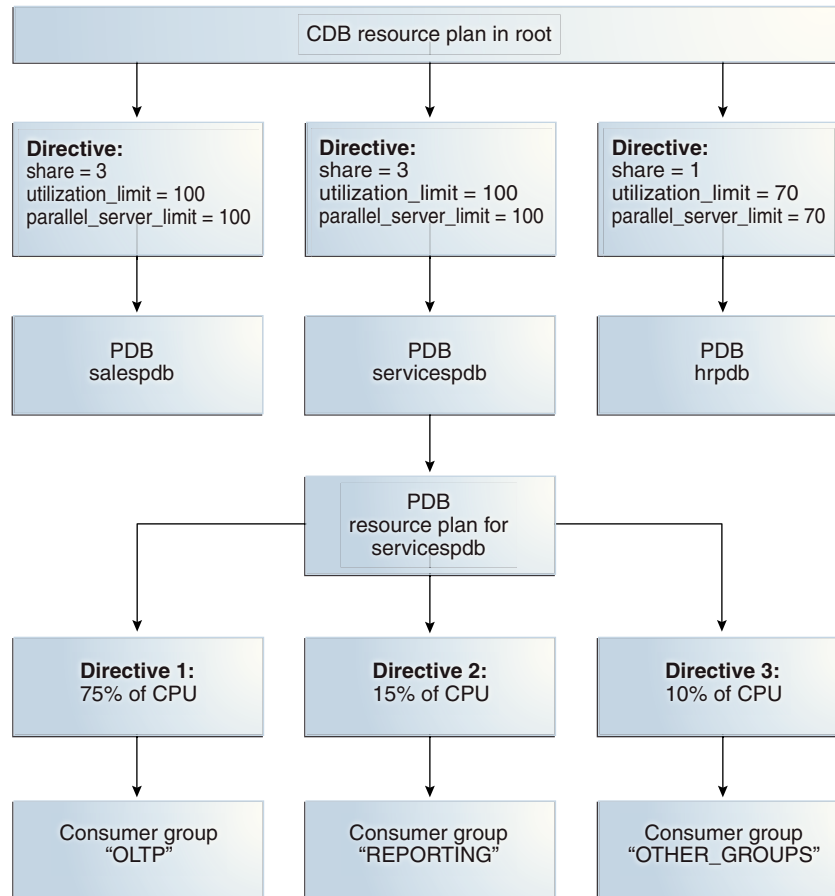

The preceding figure shows some of the directives in a PDB resource plan for the `servicespdb` PDB. Other PDBs in the CDB can also have PDB resource plans.

### 21.3.2 Creating a PDB Resource Plan

You create a PDB resource plan in the same way that you create a resource plan for a non-CDB. You use procedures in the `DBMS_RESOURCE_MANAGER` PL/SQL package to create the plan.

A CDB resource plan allocates a portion of the system's resources to a PDB. A PDB resource plan determines how this portion is allocated within the PDB.

The following is a summary of the steps required to create a PDB resource plan:



1. In SQL\*Plus, ensure that the current container is a PDB.
2. Create a pending area using the `CREATE_PENDING_AREA` procedure.
3. Create, modify, or delete consumer groups using the `CREATE_CONSUMER_GROUP` procedure.
4. Map sessions to consumer groups using the `SET_CONSUMER_GROUP_MAPPING` procedure.
5. Create the PDB resource plan using the `CREATE_PLAN` procedure.
6. Create PDB resource plan directives using the `CREATE_PLAN_DIRECTIVE` procedure.
7. Validate the pending area using the `VALIDATE_PENDING_AREA` procedure.
8. Submit the pending area using the `SUBMIT_PENDING_AREA` procedure.

Ensure that the current container is a PDB and that the user has the required privileges when you complete these steps. See *Oracle Database Administrator's Guide* for detailed information about completing these steps.

You also have the option of creating a simple resource plan that is adequate for many situations using the `CREATE_SIMPLE_PLAN` procedure. See *Oracle Database Administrator's Guide* for information about creating a simple resource plan.

**Note:**

Some restrictions apply to PDB resource plans. See "[About PDB Resource Plans](#)" for information.

### 21.3.3 Enabling a PDB Resource Plan

Enable a PDB resource plan by setting the `RESOURCE_MANAGER_PLAN` initialization parameter to the plan with an `ALTER SYSTEM` statement when the current container is the PDB.

If no plan is specified with this parameter, then no PDB resource plan is enabled for the PDB.

**Prerequisites**

Before enabling a PDB resource plan, complete the prerequisites described in "[Overview of Oracle Resource Manager in a Multitenant Environment](#)".

**To enable a PDB resource plan:**

1. In SQL\*Plus, ensure that the current container is a PDB.
2. Use an `ALTER SYSTEM` statement to set the `RESOURCE_MANAGER_PLAN` initialization parameter to the PDB resource plan.

You can also schedule a PDB resource plan change with Oracle Scheduler.

### Example 21-5 Enabling a PDB Resource Plan

The following example sets the PDB resource plan to `salespdb_plan`.

```
ALTER SYSTEM SET RESOURCE_MANAGER_PLAN = 'salespdb_plan';
```

#### See Also:

- ["About Container Access in a CDB"](#)
- ["Modifying a PDB at the System Level"](#)
- *Oracle Database Administrator's Guide* to learn how to schedule a PDB resource plan change with Oracle Scheduler

## 21.3.4 Modifying a PDB Resource Plan

You can use the `DBMS_RESOURCE_MANAGER` package to modify a PDB resource plan in the same way you would modify the resource plan for a non-CDB.

### Prerequisites

Before modifying a PDB resource plan, complete the prerequisites described in ["Overview of Oracle Resource Manager in a Multitenant Environment"](#).

### To modify a PDB resource plan:

1. In SQL\*Plus, ensure that the current container is a PDB.
2. Create a pending area:

```
exec DBMS_RESOURCE_MANAGER.CREATE_PENDING_AREA();
```

3. Modify the PDB resource plan by completing one or more of the following tasks:
  - Update a consumer group using the `UPDATE_CONSUMER_GROUP` procedure.
  - Delete a consumer group using the `DELETE_CONSUMER_GROUP` procedure.
  - Update a resource plan using the `UPDATE_PLAN` procedure.
  - Delete a resource plan using the `DELETE_PLAN` procedure.
  - Update a resource plan directive using the `UPDATE_PLAN_DIRECTIVE` procedure.
  - Delete a resource plan directive using the `DELETE_PLAN_DIRECTIVE` procedure.
4. Validate the pending area:

```
exec DBMS_RESOURCE_MANAGER.VALIDATE_PENDING_AREA();
```

5. Submit the pending area:

```
exec DBMS_RESOURCE_MANAGER.SUBMIT_PENDING_AREA();
```

 **See Also:**

- ["About PDB Resource Plans"](#)
- ["About Container Access in a CDB"](#).
- *Oracle Database Administrator's Guide* for instructions about completing the consumer group tasks

## 21.3.5 Disabling a PDB Resource Plan

You disable a PDB resource plan by unsetting the `RESOURCE_MANAGER_PLAN` initialization parameter in the PDB.

### Prerequisites

Before disabling a PDB resource plan, complete the prerequisites described in ["Overview of Oracle Resource Manager in a Multitenant Environment"](#).

### To disable a PDB resource plan:

1. In SQL\*Plus, ensure that the current container is a PDB.
2. Use an `ALTER SYSTEM` statement to unset the `RESOURCE_MANAGER_PLAN` initialization parameter for the PDB.

### Example 21-6 Disabling a PDB Resource Plan

The following example disables the PDB resource plan.

```
ALTER SYSTEM SET RESOURCE_MANAGER_PLAN = '';
```

 **See Also:**

- ["Modifying a PDB at the System Level"](#)
- See ["About Container Access in a CDB"](#).

## 21.4 Monitoring PDBs Managed by Oracle Database Resource Manager

A set of dynamic performance views enables you to monitor the results of your Oracle Database Resource Manager settings for PDBs.

This section contains the following topics:

- [About Resource Manager Views for PDBs](#)  
You can monitor the results of your Oracle Database Resource Manager settings for PDBs using views.
- [Monitoring CPU Usage for PDBs](#)  
The `V$RSRCPDBMETRIC` view enables you to track CPU metrics in milliseconds, in terms of number of sessions, or in terms of utilization for the past one minute.
- [Monitoring Parallel Execution for PDBs](#)  
The `V$RSRCPDBMETRIC` view enables you to track parallel statements and parallel server use for PDBs.
- [Monitoring the I/O Generated by PDBs](#)  
The `V$RSRCPDBMETRIC` view enables you to track the amount of I/O generated by PDBs.
- [Monitoring Memory Usage for PDBs](#)  
The `V$RSRCPDBMETRIC` view enables you to track the amount memory used by PDBs.

## 21.4.1 About Resource Manager Views for PDBs

You can monitor the results of your Oracle Database Resource Manager settings for PDBs using views.

The following views are available:

- `V$RSRCPDBMETRIC`  
The `V$RSRCPDBMETRIC` view provides current statistics on resource consumption for PDBs, including CPU usage, parallel execution, I/O generated, and memory usage.
- `V$RSRCPDBMETRIC_HISTORY`  
The columns in the `V$RSRCPDBMETRIC_HISTORY` view are the same as the columns in the `V$RSRCPDBMETRIC` view. The only difference between these views is that the `V$RSRCPDBMETRIC` view contains metrics for the past one minute only, whereas the `V$RSRCPDBMETRIC_HISTORY` view contains metrics for the last 60 minutes.
- `V$RSRC_PDB`  
The `V$RSRC_PDB` view provides cumulative statistics. The statistics are accumulated since the time that the CDB resource plan was set.
- `DBA_HIST_RSRC_PDB_METRIC`  
This view contains the historical statistics of `V$RSRCPDBMETRIC_HISTORY`, taken using Automatic Workload Repository (AWR) snapshots.

### Note:

The `V$RSRCPDBMETRIC` and `V$RSRCPDBMETRIC_HISTORY` views record statistics for resources that are not currently being managed by Resource Manager when the `STATISTICS_LEVEL` initialization parameter is set to `ALL` or `TYPICAL`.

 **See Also:**

- *Oracle Database SQL Tuning Guide* for more information about real-time SQL monitoring
- *Oracle Database Reference* to learn about `V$RSRCPDBMETRIC`, `V$RSRCPDBMETRIC_HISTORY`, `V$RSRC_PDB`, and `DBA_HIST_RSRC_PDB_METRIC`

## 21.4.2 Monitoring CPU Usage for PDBs

The `V$RSRCPDBMETRIC` view enables you to track CPU metrics in milliseconds, in terms of number of sessions, or in terms of utilization for the past one minute.

The view provides real-time metrics for each PDB and is very useful in scenarios where you are running workloads and want to continuously monitor CPU resource utilization.

The active CDB resource plan manages CPU usage for a PDB. Use this view to compare the maximum and average CPU utilization for PDBs with other PDB settings such as the following:

- CPU time used
- Time waiting for CPU
- Average number of sessions that are consuming CPU
- Number of sessions that are waiting for CPU allocation

For example, you can view the amount of CPU resources a PDB used and how long it waited for resource allocation. Alternatively, you can view how many sessions from each PDB are executed against the total number of active sessions.

### Tracking CPU Consumption in Terms of CPU Utilization for PDBs

To track CPU consumption in terms of CPU utilization, query the `CPU_UTILIZATION_LIMIT` and `AVG_CPU_UTILIZATION` columns. `AVG_CPU_UTILIZATION` lists the average percentage of the server's CPU that is consumed by a PDB. `CPU_UTILIZATION_LIMIT` represents the maximum percentage of the server's CPU that a PDB can use. This limit is set using the `UTILIZATION_LIMIT` directive attribute.

The following query displays this information by showing the container ID (`CON_ID`) and name of each PDB:

```
COLUMN PDB_NAME FORMAT A10

SELECT r.CON_ID,
       p.PDB_NAME,
       r.CPU_UTILIZATION_LIMIT,
       r.AVG_CPU_UTILIZATION
FROM   V$RSRCPDBMETRIC r,
       CDB_PDBS p
WHERE  r.CON_ID = p.CON_ID;
```

### Tracking CPU Consumption and Throttling for PDBs

Use the `CPU_CONSUMED_TIME` and `CPU_TIME_WAIT` columns to track CPU consumption and throttling in milliseconds for each PDB. The column `NUM_CPUS` represents the number of CPUs that Resource Manager is managing.

The following query displays this information by showing the container ID (`CON_ID`) and name of each PDB:

```
COLUMN PDB_NAME FORMAT A10

SELECT r.CON_ID,
       p.PDB_NAME,
       r.CPU_CONSUMED_TIME,
       r.CPU_WAIT_TIME,
       r.NUM_CPUS
FROM   V$RSRCPDBMETRIC r,
       CDB_PDBS p
WHERE  r.CON_ID = p.CON_ID;
```

### Tracking CPU Consumption and Throttling in Terms of Number of Sessions for PDBs

To track the CPU consumption and throttling in terms of number of sessions, use the `RUNNING_SESSIONS_LIMIT`, `AVG_RUNNING_SESSIONS`, and `AVG_WAITING_SESSIONS` columns. `RUNNING_SESSIONS_LIMIT` lists the maximum number of sessions from a particular PDB that can be running at any time. This limit is defined by the `UTILIZATION_LIMIT` directive attribute that you set for the PDB.

`AVG_RUNNING_SESSIONS` lists the average number of sessions that are consuming CPU, and `AVG_WAITING_SESSIONS` lists the average number of sessions that are waiting for CPU.

The following query displays this information by showing the container ID (`CON_ID`) and name of each PDB:

```
COLUMN PDB_NAME FORMAT A10

SELECT r.CON_ID,
       p.PDB_NAME,
       r.RUNNING_SESSIONS_LIMIT,
       r.AVG_RUNNING_SESSIONS,
       r.AVG_WAITING_SESSIONS
FROM   V$RSRCPDBMETRIC r,
       CDB_PDBS p
WHERE  r.CON_ID = p.CON_ID;
```

## 21.4.3 Monitoring Parallel Execution for PDBs

The `V$RSRCPDBMETRIC` view enables you to track parallel statements and parallel server use for PDBs.

Parallel execution servers for a PDB are managed with the active CDB resource plan of the PDB's CDB. To track parallel statements and parallel server use for PDBs, use the `AVG_ACTIVE_PARALLEL_STMTS`, `AVG_QUEUED_PARALLEL_STMTS`,

AVG\_ACTIVE\_PARALLEL\_SERVERS, AVG\_QUEUED\_PARALLEL\_SERVERS, and PARALLEL\_SERVERS\_LIMIT columns.

AVG\_ACTIVE\_PARALLEL\_STMTS and AVG\_ACTIVE\_PARALLEL\_SERVERS list the average number of parallel statements running and the average number of parallel servers used by the parallel statements. AVG\_QUEUED\_PARALLEL\_STMTS and AVG\_QUEUED\_PARALLEL\_SERVERS list the average number of parallel statements queued and average number of parallel servers that were requested by queued parallel statements. PARALLEL\_SERVERS\_LIMIT lists the number of parallel servers allowed to be used by the PDB.

The following query displays this information by showing the container ID (CON\_ID) and name of each PDB:

```
COLUMN PDB_NAME FORMAT A10

SELECT r.CON_ID, p.PDB_NAME, r.AVG_ACTIVE_PARALLEL_STMTS,
       r.AVG_QUEUED_PARALLEL_STMTS,
       r.AVG_ACTIVE_PARALLEL_SERVERS, r.AVG_QUEUED_PARALLEL_SERVERS,
       r.PARALLEL_SERVERS_LIMIT
FROM V$SRCPDBMETRIC r, CDB_PDBS p
WHERE r.CON_ID = p.CON_ID;
```

## 21.4.4 Monitoring the I/O Generated by PDBs

The V\$SRCPDBMETRIC view enables you to track the amount of I/O generated by PDBs.

I/O is limited for a PDB by setting the MAX\_IOPS initialization parameter or the MAX\_MBPS initialization parameter in the PDB. Use this view to compare the I/O generated by PDBs in terms of the number of operations each second and the number of megabytes each second.

### Tracking the Number of I/O Operations Generated Each Second by PDBs

To track the I/O operations generated each second by PDBs during the previous minute, use the IOPS column.

The following query displays this information by showing the container ID (CON\_ID) and name of each PDB:

```
COLUMN PDB_NAME FORMAT A10

SELECT r.CON_ID, p.PDB_NAME, r.IOPS
FROM V$SRCPDBMETRIC r, CDB_PDBS p
WHERE r.CON_ID = p.CON_ID;
```

### Tracking the Number Megabytes Generated for I/O Operations Each Second by PDBs

To track number of megabytes generated for I/O operations each second by PDBs during the previous minute, use the IOMBPS column.

The following query displays this information by showing the container ID (CON\_ID) and name of each PDB:

```
COLUMN PDB_NAME FORMAT A10

SELECT r.CON_ID, p.PDB_NAME, r.IOMBPS
       FROM V$RSRCPDBMETRIC r, CDB_PDBS p
       WHERE r.CON_ID = p.CON_ID;
```

## 21.4.5 Monitoring Memory Usage for PDBs

The V\$RSRCPDBMETRIC view enables you to track the amount memory used by PDBs.

Use this view to track the amount of SGA, PGA, buffer cache, and shared pool memory currently used by PDBs.

To track the current memory usage, in bytes, for specific PDBs, use the SGA\_BYTES, PGA\_BYTES, BUFFER\_CACHE\_BYTES, and SHARED\_POOL\_BYTES columns.

The following query displays this information by showing the container ID (CON\_ID) and name of each PDB:

```
COLUMN PDB_NAME FORMAT A10

SELECT r.CON_ID, p.PDB_NAME, r.SGA_BYTES, r.PGA_BYTES,
       r.BUFFER_CACHE_BYTES, r.SHARED_POOL_BYTES
       FROM V$RSRCPDBMETRIC r, CDB_PDBS p
       WHERE r.CON_ID = p.CON_ID;
```



# 22

## Using Oracle Scheduler with a CDB

You can use Oracle Scheduler to schedule jobs in a multitenant container database (CDB).

Before using Oracle Scheduler with a CDB, meet the following requirements:

- You understand how to configure and manage a CDB.
- You understand how to use Oracle Scheduler to schedule jobs in a non-CDB.

This chapter contains the following topics:

- [DBMS\\_SCHEDULER Invocations in a CDB](#)  
Most scheduler calls work the same way as they do in non-CDBs, except for two scheduler global attributes.
- [Job Coordinator and Slave Processes in a CDB](#)  
The major CDB-related changes are to the job coordinator process.
- [Using DBMS\\_JOB](#)  
You can create a job using `DBMS_JOB` within a PDB, and it will work as before. However, `DBMS_JOB` has been superseded by `DBMS_SCHEDULER`.
- [Processes to Close a PDB](#)  
If a PDB is closed with the immediate option, then the coordinator terminates jobs running in the PDB, and the jobs must be recovered before they can run again.
- [New and Changed CDB Views](#)  
Some CDB views are specific to CDBs, whereas others have a CDB-specific column.

### See Also:

- ["Administering a Multitenant Environment"](#)
- *Oracle Database Administrator's Guide*

### 22.1 DBMS\_SCHEDULER Invocations in a CDB

Most scheduler calls work the same way as they do in non-CDBs, except for two scheduler global attributes.

The `JOB_QUEUE_PROCESSES` initialization parameter specifies the maximum number of job slaves per instance that can be created for the execution of `DBMS_JOB` jobs and Oracle Scheduler (`DBMS_SCHEDULER`) jobs. The range of values is 0 to 4000 (default).

To limit job slaves in a CDB environment, you can set `JOB_QUEUE_PROCESSES` in the following locations:

- CDB root

Set `JOB_QUEUE_PROCESSES` to the maximum number of slave processes that Scheduler can use simultaneously in the entire database instance.

If `JOB_QUEUE_PROCESSES` is 0 in the CDB root, then `DBMS_JOB` and Oracle Scheduler jobs cannot run in the root or any PDB, regardless of the `JOB_QUEUE_PROCESSES` setting at the PDB level.
- PDB

Set `JOB_QUEUE_PROCESSES` to the maximum number of simultaneous jobs for this PDB. The actual number depends on the resources assigned by Resource Manager and the demand in other containers. When multiple PDBs request jobs, Oracle Scheduler attempts to give all PDBs a fair share of the processes.

If `JOB_QUEUE_PROCESSES` is 0 in a PDB, then `DBMS_JOB` and Oracle Scheduler jobs cannot run in this PDB, regardless of the `JOB_QUEUE_PROCESSES` setting in the CDB root.

You must set all global Oracle Scheduler attributes at the PDB level. For example, if you set the `EMAIL_SENDER` attribute in the root database using `DBMS_SCHEDULER.SET_ATTRIBUTE`, then it applies to the jobs that run in the root, not the jobs running in a specific PDB. If you choose a new `EMAIL_SENDER` for a PDB, then you must set the global attribute in this PDB.



#### See Also:

*Oracle Database Reference* to learn more about `JOB_QUEUE_PROCESSES`

## 22.2 Job Coordinator and Slave Processes in a CDB

The major CDB-related changes are to the job coordinator process.

In a non-CDB, the coordinator looks at all jobs that are ready to run, picks a subset of them to run, and assigns them to job slaves. It also opens and closes windows, which changes the resource plan in effect for the database.

That is essentially what happens inside a CDB except for the following:

- Jobs are selected from all PDBs

The coordinator looks at the root database and all the child PDBs and selects jobs based on the job priority, the job scheduled start time, and the availability of resources to run the job. The latter criterion depends on the consumer group of the job and the resource plan currently in effect. The coordinator makes no attempt to be fair to every PDB. The only way to ensure that jobs from a PDB are not starved is to allocate enough resources to it.
- Windows are open in the PDB and root database levels

In a non-CDB, only one window can be open at any given time. In a CDB, there are two levels of windows. At the PDB level, windows can be used to set resource plans that allocate resources among consumer groups belonging to that PDB. At the root database level, windows can allocate resources to different PDBs.

Therefore, at any time, there can be a window open in the root database and one in each PDB.

- Job slave switches to the specific PDB it belongs to

The job slaves are essentially the same as in a non-CDB, except that when a slave executes a job, it switches to the PDB that the job belongs to and then executes it. The rest of the code is essentially unchanged.

## 22.3 Using DBMS\_JOB

You can create a job using `DBMS_JOB` within a PDB, and it will work as before. However, `DBMS_JOB` has been superseded by `DBMS_SCHEDULER`.

Support for `DBMS_JOB` might be removed in future releases of Oracle Database. For this reason, Oracle recommends that you switch from `DBMS_JOB` to `DBMS_SCHEDULER`.

For the scheduler, the coordinator now selects jobs to run from every single PDB and not just a single database as was the case before. Also, for the scheduler, the slave will switch into a PDB before executing a job; otherwise, the code is essentially unchanged.

### See Also:

*Oracle Database Administrator's Guide* for information about support for `DBMS_JOB`

## 22.4 Processes to Close a PDB

If a PDB is closed with the immediate option, then the coordinator terminates jobs running in the PDB, and the jobs must be recovered before they can run again.

In an Oracle RAC database, the coordinator can, in most cases, recover the jobs on another instance where that PDB is open. So, if the coordinator on the first instance can find another instance where the PDB is still open, it moves the jobs there. In certain cases, moving the jobs to another instance may not be possible. For example, if the PDB in question is not open anywhere else, the jobs cannot be moved. Also, moving a job to another instance is not possible when the job has the `INSTANCE_ID` attribute set. In this case the job cannot run until the PDB on that instance is open again.

In a non-Oracle RAC case, the question of moving jobs does not arise. Terminated jobs can only be recovered after the PDB is opened again.

## 22.5 New and Changed CDB Views

Some CDB views are specific to CDBs, whereas others have a CDB-specific column.

- `V$` and `GV$` views have a `CON_ID` column that identifies a container whose data is represented by a `CDB_*` row. In non-CDBs, the `CON_ID` column is `NULL`.
- `CDB_*` views correspond to all Scheduler `DBA_*` views.

In a PDB, these views only show objects visible through a corresponding `DBA_*` view, but all objects are visible in the root. The `CDB_*` view contains all columns found in a given `DBA_*` view and the column (`CON_ID`). In non-CDBs, this column is `NULL`.

# Using Oracle Database Vault with a CDB

You can use Oracle Database Vault in a multitenant container database (CDB).

This section contains the following topics:

- [About Oracle Database Vault](#)  
The Oracle Database Vault security controls protect application data from unauthorized access, and comply with privacy and regulatory requirements.
- [How Oracle Database Vault Works in a Multitenant Environment](#)  
To provide increased security for consolidation, you can use Oracle Database Vault with Oracle Multitenant.
- [Manually Installing Oracle Database Vault in a Multitenant Environment](#)  
Under certain conditions, for a multitenant environment, you must manually install Oracle Database Vault.
- [Verifying That Database Vault Is Configured and Enabled](#)  
The `DBA_DV_STATUS`, `CDB_DV_STATUS`, `DBA_OLS_STATUS`, and `CDB_OLS_STATUS` data dictionary views verify if Oracle Database is configured and enabled.
- [Registering Database Vault in the CDB Root](#)  
In a multitenant environment, you register Oracle Database Vault with common users who will use the Database Vault-enforced roles in the CDB root.
- [Registering Database Vault Common Users to Manage Specific PDBs](#)  
In a multitenant environment, you must register Oracle Database Vault in the root first, then in the PDBs afterward.
- [Creating Common Database Vault Accounts for a Plugged in Database Vault PDB](#)  
From SQL\*Plus, in a multitenant environment, you can plug in a database that already has Database Vault enabled.
- [Realms in a Multitenant Environment](#)  
In a multitenant environment, you can create a realm to protect common objects in the application root.
- [Realm Authorizations in a Multitenant Environment](#)  
In a multitenant environment, the rules and behavior for common realm authorizations are similar to the authorizations for other common objects.
- [Rule Sets and Rules in a Multitenant Environment](#)  
In a multitenant environment, you can create a rule set and its associated rules in the application root.
- [Command Rules in a Multitenant Environment](#)  
In a multitenant environment, you can create common and local command rules in either the CDB root or the application root.
- [Oracle Database Vault Policies in a Multitenant Environment](#)  
Oracle Database Vault policies are only local to the pluggable database (PDB) in which they were created.

- [Converting a Standalone Oracle Database to a PDB and Plugging It into a CDB](#)  
You can convert a standalone Oracle Database Release 12c or later database to a PDB, and then plug this PDB into a CDB.

## 23.1 About Oracle Database Vault

The Oracle Database Vault security controls protect application data from unauthorized access, and comply with privacy and regulatory requirements.

You can deploy controls to block privileged account access to application data and control sensitive operations inside the database using trusted path authorization. Through the analysis of privileges and roles, you can increase the security of existing applications by using least privilege best practices. Oracle Database Vault secures existing database environments transparently, eliminating costly and time consuming application changes.

### Related Topics

- *Oracle Database Vault Administrator's Guide*

## 23.2 How Oracle Database Vault Works in a Multitenant Environment

To provide increased security for consolidation, you can use Oracle Database Vault with Oracle Multitenant.

Oracle Database Vault can prevent privileged user access inside a pluggable database (PDB) and between the PDB and the common privileged user at the container database. Each PDB has its own Database Vault metadata, such as realms, rule sets, command rules, default policies (such as default realms), and so on. In addition, the objects within the `DVSYS` and `DVF` schemas are automatically available to any child PDBs. Both schemas are common user schemas.

You can configure common realms in the application root only, but you can create common rule sets and command rules in either the application root or the CDB root. A common command rule in the application root applies to its associated PDBs, and common command rules in the CDB root apply to all PDBs in the CDB environment. The ability to create common realms and command rules enables you to create policies that use a shared set of realms, rule sets, or command rules throughout the CDB environments, rather than having to create these same components for every PDB in the multitenant environment. The common protection applies for all PDBs associated with the application root that have Oracle Database Vault enabled.

You can create individual local policies for each PDB. When you use Database Vault to protect an object, Database Vault subjects common privileges for common objects to the same enforcement rules as local system privileges.

When you configure a PDB that has Database Vault enabled, the `DVSYS` schema is a common user schema that is stored in the root. This means that all the objects within the `DVSYS` schema (tables, data dictionary views, user accounts, PL/SQL packages, default policies, and so on) are subject to the common privileges available for this schema. In other words, you can create realms, factors, and so on in the root to protect the schema in the root. Ensure that you configure Database Vault in the root first, before you configure it in the associated PDBs.

When you enable Oracle Database Vault in the CDB root, you can choose either regular mode or strict mode. The settings propagate throughout the CDB based on the setting you choose. For example, suppose a CDB contains both Database Vault-enabled PDBs and PDBs in which Database Vault is not enabled. If you enable Database Vault using regular mode, then both types of PDBs continue to function normally. If you enable Database Vault using strict mode, then the Database Vault-disabled PDBs operate in restricted mode.

Figure 23-1 illustrates how the database in regular mode allows different access for common and local database administrators depending if Database Vault is enabled. In this scenario, neither the common user nor the local users have access to the realms in PDB1 and PDB2. Both the common user and the PDB3 local user have access to the Custom App application in PDB3, where Database Vault is not enabled.

**Figure 23-1 Oracle Database Vault in a Multitenant Environment with Regular Mode**

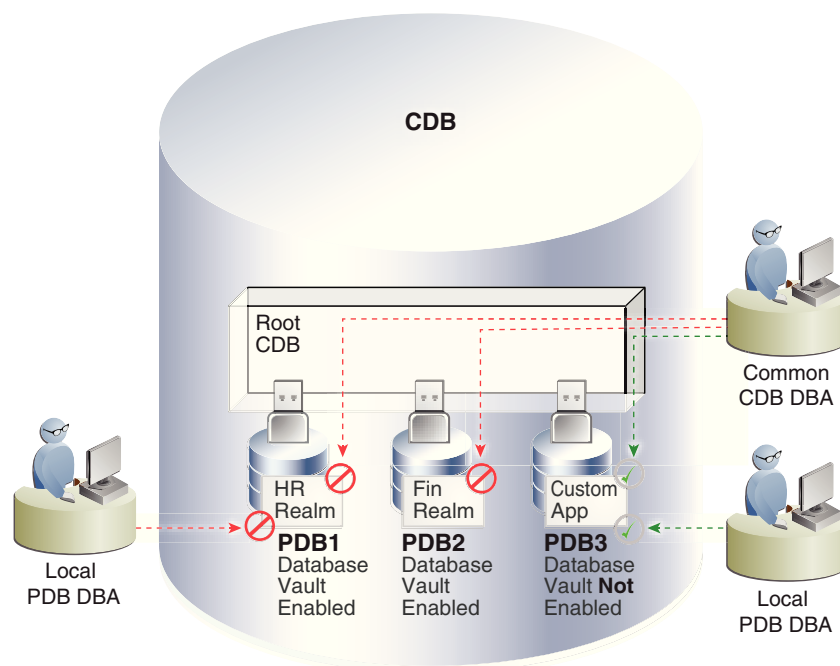

### Related Topics

- [Realms in a Multitenant Environment](#)  
In a multitenant environment, you can create a realm to protect common objects in the application root.
- [Rule Sets and Rules in a Multitenant Environment](#)  
In a multitenant environment, you can create a rule set and its associated rules in the application root.
- [Command Rules in a Multitenant Environment](#)  
In a multitenant environment, you can create common and local command rules in either the CDB root or the application root.

- [Converting a Standalone Oracle Database to a PDB and Plugging It into a CDB](#)  
You can convert a standalone Oracle Database Release 12c or later database to a PDB, and then plug this PDB into a CDB.

## 23.3 Manually Installing Oracle Database Vault in a Multitenant Environment

Under certain conditions, for a multitenant environment, you must manually install Oracle Database Vault.

For example, you must manually install Oracle Database Vault if a release 11g Oracle database without Database Vault is upgraded to release 12c, then converted to a PDB to be plugged into a 12c Database Vault-enabled database. In addition, you must manually install Oracle Database Vault (and Oracle Label Security) in a PDB if this PDB does not have these products when the PDB has been plugged into a CDB where Database Vault and Label Security are installed.

1. As user who has been granted the `SYSDBA` administrative privilege, log in to the PDB in which you want to install Oracle Database Vault.

For example, to log in to a PDB named `hr_pdb`:

```
sqlplus sec_admin@hr_pdb as sysdba
Enter password: password
```

To find the available PDBs, run the `show pdbs` command. To check the current PDB, run the `show con_name` command.

2. If necessary, check if Oracle Database Vault and Oracle Label Security are already installed on this PDB.

If the `DVSYs` account (for Database Vault) and the `LBACSYS` account (for Label Security) exist, then Database Vault and Label Security exist on the PDB.

```
SELECT USERNAME FROM DBA_USERS WHERE USERNAME IN ('DVSYs', 'LBACSYS');
```

3. If neither Database Vault nor Label Security have been installed, then install Oracle Label Security by executing the `catols.sql` script.

```
@$ORACLE_HOME/rdbms/admin/catols.sql
```

Oracle Label Security must be installed before you can install Oracle Database Vault.

4. Install Oracle Database Vault by executing the `catmac.sql` script.

```
@$ORACLE_HOME/rdbms/admin/catmac.sql
```

5. At the `Enter` value for 1 prompt, enter `SYSTEM` as the tablespace to install `DVSYs`.
6. At the `Enter` value for 2 prompt, enter the temporary tablespace for the PDB.

After the installation is complete, you can register Oracle Database Vault in the PDB. If Database Vault is not registered in the CDB already, you must close the PDB before you can register Database Vault in the CDB root. Database Vault must be registered in



CDB root before it can be registered in the PDB. After Database Vault is registered in the CDB root and the database has been restarted, then you can open the PDB and register Database Vault.

### Related Topics

- *Oracle Database Vault Administrator's Guide*

## 23.4 Verifying That Database Vault Is Configured and Enabled

The `DBA_DV_STATUS`, `CDB_DV_STATUS`, `DBA_OLS_STATUS`, and `CDB_OLS_STATUS` data dictionary views verify if Oracle Database is configured and enabled.

In addition to Oracle Database Vault administrators, the Oracle Database `SYS` user and users who have been granted the `DBA` role can query these views.

- For Database Vault:
  - If you want to find the Database Vault status for a non-multitenant database, or in a multitenant environment for the root only or an individual PDB, then query `DBA_DV_STATUS`. For example:

```
SELECT * FROM DBA_DV_STATUS;
```

Output similar to the following appears:

NAME	STATUS
-----	-----
DV_CONFIGURE_STATUS	TRUE
DV_ENABLE_STATUS	TRUE

- If you want to find the Database Vault status of all PDBs in a multitenant environment, as a common user with administrative privileges, then query `CDB_DV_STATUS`, which provides the addition of a container ID (`CON_ID`) field.
- For Oracle Label Security, query the following data dictionary views, which are similar to their Database Vault equivalent views:
  - `DBA_OLS_STATUS`
  - `CDB_OLS_STATUS`

## 23.5 Registering Database Vault in the CDB Root

In a multitenant environment, you register Oracle Database Vault with common users who will use the Database Vault-enforced roles in the CDB root.

1. In a multitenant environment, log into the root of the database instance as a user who has privileges to create users and grant the `CREATE SESSION` and `SET CONTAINER` privileges.

For example:

```
sqlplus c##dba_debra
Enter password: password
```

2. Select user accounts (or create new users) that will be used for the Database Vault Owner (DV\_OWNER role) and Database Vault Account Manager (DV\_ACCTMGR role) accounts.

Oracle strongly recommends that you maintain two accounts for each role. One account, the primary named user account, will be used on a day-to-day basis and the other account will be used as a backup account in case the password of the primary account is lost and must be reset.

Prepend the names of these accounts with c## or C##. For example:

```
GRANT CREATE SESSION, SET CONTAINER TO c##sec_admin_owen IDENTIFIED BY
password CONTAINER = ALL;
GRANT CREATE SESSION, SET CONTAINER TO c##dbv_owner_root_backup
IDENTIFIED BY password CONTAINER = ALL;
GRANT CREATE SESSION, SET CONTAINER TO c##accts_admin_ace IDENTIFIED BY
password CONTAINER = ALL;
GRANT CREATE SESSION, SET CONTAINER TO c##dbv_acctmgr_root_backup
IDENTIFIED BY password CONTAINER = ALL;
```

In this specification:

- Create the primary accounts (c##sec\_admin\_owen and c##accts\_admin\_ace) if these do not already exist for the new roles, DV\_ADMIN and DV\_ACCTMGR.
  - Replace *password* with a password that is secure.
3. Connect to the root as user SYS with the SYSDBA administrative privilege

```
CONNECT SYS AS SYSDBA
Enter password: password
```

4. Configure the two backup Database Vault user accounts.

For example:

```
BEGIN
  CONFIGURE_DV (
    dvowner_username => 'c##dbv_owner_root_backup',
    dvacctmgr_username => 'c##dbv_acctmgr_root_backup',
    force_local_dvowner => FALSE);
END;
/
```

In this example, setting *force\_local\_dvowner* to FALSE enables the common users to have DV\_OWNER privileges for the PDBs that are associated with this CDB root. Setting it to TRUE restricts the common DV\_OWNER user to have the DV\_OWNER role privileges for the CDB root only. If you grant DV\_OWNER locally to the CDB root common user, then that user cannot grant the DV\_OWNER role commonly to any other user.

5. Run the `utlrlp.sql` script to recompile invalidated objects in the root.

```
@?/rdbms/admin/utlrlp.sql
```

If the script provides instructions, follow them, and then run the script again. If the script terminates abnormally without giving any instructions, then run it again.

6. Connect to the root as the primary Database Vault Owner user that you just configured.

For example:

```
CONNECT c##dbv_owner_root_backup  
Enter password: password
```

7. Enable Oracle Database Vault using one of the following commands:

- To enable Oracle Database Vault to use regular mode:

```
EXEC DBMS_MACADM.ENABLE_DV;
```

- If every associated PDB will need to have Database Vault enabled in this database, then use the following command. (You will need to enable each of these PDBs after you complete this procedure.) PDBs that do not have Database Vault enabled will be in restricted mode after the database is restarted and until Database Vault is enabled in the PDB:

```
EXEC DBMS_MACADM.ENABLE_DV (strict_mode => 'y');
```

8. Connect with the `SYSDBA` administrative privilege.

```
CONNECT / AS SYSDBA
```

9. Restart the database.

```
SHUTDOWN IMMEDIATE  
STARTUP
```

10. Verify that Oracle Database Vault and Oracle Label Security are installed and enabled.

```
SELECT * FROM DBA_DV_STATUS;  
SELECT * FROM DBA_OLS_STATUS;  
SELECT * FROM CDB_DV_STATUS;  
SELECT * FROM CDB_OLS_STATUS;
```

11. Connect as the backup `DV_OWNER` user and then grant the `DV_OWNER` role to the primary `DV_OWNER` user that you created earlier.

For example:

```
CONNECT c##dbv_owner_root_backup  
Enter password: password
```

```
GRANT DV_OWNER TO c##sec_admin_owen WITH ADMIN OPTION;
```

12. Connect as the backup DV\_ACCTMGR user and then grant the DV\_ACCTMGR role to the backup DV\_ACCTMGR user.

For example:

```
CONNECT c##dbv_acctmgr_root_backup  
Enter password: password
```

```
GRANT DV_ACCTMGR TO c##accts_admin_ace WITH ADMIN OPTION;
```

13. Store the two backup account passwords in a safe location such as a privileged account management (PAM) system in case they are needed in the future.

### Related Topics

- [Verifying That Database Vault Is Configured and Enabled](#)  
The DBA\_DV\_STATUS, CDB\_DV\_STATUS, DBA\_OLS\_STATUS, and CDB\_OLS\_STATUS data dictionary views verify if Oracle Database is configured and enabled.
- *Oracle Database Vault Administrator's Guide*
- *Oracle Database Vault Administrator's Guide*

## 23.6 Registering Database Vault Common Users to Manage Specific PDBs

In a multitenant environment, you must register Oracle Database Vault in the root first, then in the PDBs afterward.

If you try to register in a PDB first, then an ORA-47503: Database Vault is not enabled on CDB\$ROOT error appears.

1. If you have not already done so, then identify or create named common user accounts to be used as the Database Vault accounts along with associated backup accounts.
2. Ensure that you have registered Oracle Database Vault in the CDB root and that the DV\_OWNER role was granted commonly to the common user.
3. Connect to the PDB as an administrator who is local to the PDB.

For example:

```
CONNECT dba_debra@pdb_name  
Enter password: password
```

To find the available PDBs, query the DBA\_PDBS data dictionary view. To check the current PDB, run the show con\_name command.

4. Grant the CREATE SESSION and SET CONTAINER privileges to the users for this PDB.

For example:

```
GRANT CREATE SESSION, SET CONTAINER TO c##sec_admin_owen CONTAINER =  
CURRENT;  
GRANT CREATE SESSION, SET CONTAINER TO c##accts_admin_ace CONTAINER =  
CURRENT;
```

5. Connect as user SYS with the SYSDBA administrative privilege

```
CONNECT SYS@pdb_name AS SYSDBA
Enter password: password
```

6. While still in the PDB, configure the two backup Database Vault user accounts.

```
BEGIN
  CONFIGURE_DV (
    dvowner_username      => 'c##dbv_owner_root_backup',
    dvacctmgr_username    => 'c##dbv_acctmgr_root_backup');
END;
/
```

In this example, the `force_local_dvowner` parameter is omitted because it is unnecessary. All common users who are configured within a PDB are restricted to the scope of the PDB.

7. Run the `utlrbp.sql` script to recompile invalidated objects in this PDB.

```
@?/rdbms/admin/utlrbp.sql
```

If the script provides instructions, follow them, and then run the script again. If the script terminates abnormally without giving any instructions, then run it again.

8. Connect to the PDB as the backup Database Vault Owner user that you just configured.

For example:

```
CONNECT c##dbv_owner_root_backup@pdb_name
Enter password: password
```

9. Enable Oracle Database Vault in this PDB.

```
EXEC DBMS_MACADM.ENABLE_DV;
```

10. Connect to the CDB with the SYSDBA administrative privilege.

```
CONNECT / AS SYSDBA
```

11. Close and reopen the PDB.

For example:

```
ALTER PLUGGABLE DATABASE pdb_name CLOSE IMMEDIATE;

ALTER PLUGGABLE DATABASE pdb_name OPEN;
```

12. Verify that the PDB is configured and enabled for Database Vault.

```
CONNECT SYS@pdb_name AS SYSDBA
Enter password: password
```

```
SELECT * FROM DBA_DV_STATUS;
```

13. Connect as the backup DV\_OWNER user and then grant the DV\_OWNER role to the primary DV\_OWNER user that you created earlier.

For example:

```
CONNECT c##dbv_owner_root_backup
Enter password: password
```

```
GRANT DV_OWNER TO c##sec_admin_owen WITH ADMIN OPTION;
```

14. Connect as the backup DV\_ACCTMGR user and then grant the DV\_ACCTMGR role to the primary DV\_ACCTMGR user.

For example:

```
CONNECT c##dbv_acctmgr_root_backup
Enter password: password
```

```
GRANT DV_ACCTMGR TO c##acct_admin_ace WITH ADMIN OPTION;
```

15. Store the two backup account passwords in a safe location such as a privileged account management (PAM) system in case they are needed in the future.

#### Related Topics

- [Verifying That Database Vault Is Configured and Enabled](#)  
The DBA\_DV\_STATUS, CDB\_DV\_STATUS, DBA\_OLS\_STATUS, and CDB\_OLS\_STATUS data dictionary views verify if Oracle Database is configured and enabled.
- *Oracle Database Vault Administrator's Guide*
- *Oracle Database Vault Administrator's Guide*

## 23.7 Creating Common Database Vault Accounts for a Plugged in Database Vault PDB

From SQL\*Plus, in a multitenant environment, you can plug in a database that already has Database Vault enabled.

In this scenario, the plugged-in PDB has its own local Database Vault accounts. Be aware that if you plug a Database Vault-enabled database into a CDB that is not Database Vault enabled, then the PDB will remain in restricted mode until you enable Database Vault in the CDB and then restart the CDB. If you plug a non-Database Vault-enabled PDB into a CDB that is Database Vault enabled, then the PDB remains in restricted mode until you enable Database Vault in the PDB and then restart the PDB. This plugged-in non-Database Vault enabled PDB is still usable. However, if the CDB is Database Vault enabled with the strict option set, then the PDB must be Database Vault enabled.

To enable a common user to manage the Database Vault configuration for this PDB:

1. Log into the PDB as the local primary Database Vault owner.

For example:

```
sqlplus dbv_owner@pdb_name  
Enter password: password
```

For example:

To find the available PDBs, execute the `show pdbs` command. To check the current PDB, run the `show con_name` command.

2. Grant the common Database Vault `DV_OWNER` users the `CREATE SESSION` and `SET CONTAINER` privileges, and the appropriate Database Vault roles.

The following accounts will be the primary and the backup accounts:

```
GRANT CREATE SESSION, SET CONTAINER, DV_OWNER TO c##dbv_owner_root WITH  
ADMIN OPTION;  
GRANT CREATE SESSION, SET CONTAINER, DV_OWNER TO  
c##dbv_owner_root_backup WITH ADMIN OPTION;
```

3. Connect as a user who has been granted the `DV_ACCTMGR` role.
4. Create the `DV_ACCTMGR` common accounts.

```
GRANT CREATE SESSION, SET CONTAINER, DV_ACCTMGR TO c##dbv_acctmgr_root  
WITH ADMIN OPTION;  
GRANT CREATE SESSION, SET CONTAINER, DV_ACCTMGR TO  
c##dbv_acctmgr_root_backup WITH ADMIN OPTION;
```

### Related Topics

- [Verifying That Database Vault Is Configured and Enabled](#)  
The `DBA_DV_STATUS`, `CDB_DV_STATUS`, `DBA_OLS_STATUS`, and `CDB_OLS_STATUS` data dictionary views verify if Oracle Database is configured and enabled.
- *Oracle Database Vault Administrator's Guide*
- *Oracle Database Vault Administrator's Guide*

## 23.8 Realms in a Multitenant Environment

In a multitenant environment, you can create a realm to protect common objects in the application root.

The advantage of creating a realm in the application root instead of creating a large number of objects and realms around these objects within individual pluggable databases (PDBs) is that you can create them in one place, the application root. This way, you can manage them centrally.

You cannot create a common realm in the CDB root.

A Database Vault common realm can be either a regular realm or a mandatory realm. The realm protects only objects within the application root, not local objects in a PDB. The CDB root, application root, and any affected PDBs all must be Database Vault enabled.

To configure a common realm, you must be commonly granted the `DV_OWNER` or `DV_ADMIN` role. To grant common authorizations for a common realm, you must be in

the application root. To propagate the realm to the PDBs that are associated with the application root, you must synchronize the application root. For example, to synchronize an application called `saas_sales_app`

```
ALTER PLUGGABLE DATABASE APPLICATION saas_sales_app SYNC;
```

### Related Topics

- *Oracle Database Vault Administrator's Guide*

## 23.9 Realm Authorizations in a Multitenant Environment

In a multitenant environment, the rules and behavior for common realm authorizations are similar to the authorizations for other common objects.

### Local Authorization for a Common Realm

The local authorization for a common realm refers to the authorization a user has for the PDB that this user is accessing.

The rules for the local authorization for a common realm are as follows:

- A user who has been commonly granted the `DV_OWNER` or `DV_ADMIN` role can grant local authorization to common users, common roles, local users, and local roles. The common `DV_OWNER` or `DV_ADMIN` user can also remove local authorization from a common realm in a PDB.
- A local Database Vault administrator can authorize locally (that is, grant local authorizations to both local and common users) within the PDB. A common Database Vault administrator can also grant authorizations in each PDB. A common realm authorization can only be granted by a common Database Vault administrator in the application root.
- The common Database Vault administrator can both add or remove local authorization to and from a common realm from within the PDB.
- If a common user has only local authorization for a common realm, then this user cannot access the common realm in any other PDB than this local authorization.
- A common user or a common role can have both the local authorization and the common authorization to a common realm at the same time. Removing a common user's local authorization from a common realm does not affect the common user's common authorization. Removing a common user's common authorization from a common realm does not affect the common user's local authorization.

### Common Authorization for a Common Realm

The common authorization for a common realm refers to the authorization a common user or a common role has in the application root while the authorization takes effect in every container that is Database Vault enabled.

The rules for the local authorization for a common realm are as follows:

- A user who has been commonly granted the `DV_OWNER` or `DV_ADMIN` role can grant common realm authorization to common users or roles in the application root. This common Database Vault administrator can perform the removal of common authorizations while in the application root.



- This common authorization applies to the containers that have been Database Vault enabled in the CDB.
- If a common user is authorized to a common realm in the application root, then this user has access to the objects protected by the common realm in the application root and any application PDBs.
- Any rule sets that are associated with a common realm must be common rule sets. The rules that are added to a common rule set that is associated with common authorization cannot involve any local objects.

#### **How the Authorization of a Realm Works in Both the Application Root and in an Individual PDB**

During the Database Vault enforcement in a container, a common realm performs the same enforcement behaviors as the same realm when it is used locally in a PDB.

## 23.10 Rule Sets and Rules in a Multitenant Environment

In a multitenant environment, you can create a rule set and its associated rules in the application root.

A common realm must use a common rule set when the associated realm or command rule is evaluated by Database Vault. The common rule set and its rules can only be created in the application root. After the common rule set is created, it exists in every container that is associated with the root where the common rule set is created. The common rule set can only include common rules.

To configure a common rule set and its rules, you must be commonly granted the `DV_OWNER` or `DV_ADMIN` role.

#### **Related Topics**

- [Command Rules in a Multitenant Environment](#)

In a multitenant environment, you can create common and local command rules in either the CDB root or the application root.

## 23.11 Command Rules in a Multitenant Environment

In a multitenant environment, you can create common and local command rules in either the CDB root or the application root.

Common command rules can be associated only with common realms, rule sets, and rules. Local command rules can be associated only with local realm, rule sets, and rules.

To apply these command rules to the entire multitenant environment, you must execute the command rule procedures from the CDB root or application root as a common user who has been granted the `DVADM` or `DVOWNER` role. A common command rule that is created in the CDB root will be applied to all PDBs in that CDB environment. A common command rule that is created in the application root will only be applied to the PDBs that are associated with this application root. To propagate the command rule to the PDBs that are associated with the CDB root or application root, you must synchronize the PDB. For example, to synchronize an application root called `saas_sales_app` to its application PDBs:

```
ALTER PLUGGABLE DATABASE APPLICATION saas_sales_app SYNC;
```

To synchronize a common command rule in the CDB root to a PDB:

```
ALTER PLUGGABLE DATABASE APPLICATION APP$CDB$SYSTEM SYNC;
```

You can check a user's roles by querying the `USER_ROLE_PRIVS` data dictionary view. To find information about command rules, query the `DBA_DV_COMMAND_RULE` data dictionary view.

## 23.12 Oracle Database Vault Policies in a Multitenant Environment

Oracle Database Vault policies are only local to the pluggable database (PDB) in which they were created.

That is, if you created the policy in a PDB, then only local realms and command rules can be added to it. You cannot create Database Vault policies that can have common realms or common command rules.

## 23.13 Converting a Standalone Oracle Database to a PDB and Plugging It into a CDB

You can convert a standalone Oracle Database Release 12c or later database to a PDB, and then plug this PDB into a CDB.

1. Connect to the root as a user who has been granted the `DV_OWNER` role.

For example:

```
sqlplus c##sec_admin  
Enter password: password
```

2. Grant the `DV_PATCH_ADMIN` role to user `SYS` with `CONTAINER = CURRENT`.

```
GRANT DV_PATCH_ADMIN TO SYS CONTAINER = CURRENT;
```

3. In the root, connect as user `SYS` with the `SYSOPER` system privilege.

For example:

```
CONNECT SYS AS SYSOPER -- Or, CONNECT SYS@hrpdb AS SYSOPER  
Enter password: password
```

4. Restart the database in read-only mode.

For example:

```
SHUTDOWN IMMEDIATE  
STARTUP MOUNT  
ALTER DATABASE OPEN READ ONLY
```

5. Connect to the Database Vault-enabled database as a user who has the `DV_OWNER` role.

For example:

```
CONNECT sec_admin@dv_db
```

6. Grant the DV\_PATCH\_ADMIN role to user SYS on this database.

```
GRANT DV_PATCH_ADMIN TO SYS;
```

7. Optionally, run the DBMS\_PDB.CHECK\_PLUG\_COMPATIBILITY function to determine whether the unplugged PDB is compatible with the CDB.

When you run the function, set the following parameters:

- `pdb_descr_file`: Set this parameter to the full path to the XML file that will contain a description of the PDB.
- `store_report`: Set this parameter to indicate whether you want to generate a report if the PDB is not compatible with the CDB. Set it to `TRUE` to generate a report or `FALSE` to not generate a report. A generated report is stored in the `PDB_PLUG_IN_VIOLATIONS` temporary table and is generated only if the PDB is not compatible with the CDB.

For example, to determine whether a PDB described by the `/disk1/usr/dv_db_pdb.xml` file is compatible with the current CDB, run the following PL/SQL block:

```
SET SERVEROUTPUT ON
DECLARE
  compatible CONSTANT VARCHAR2(3) :=
    CASE DBMS_PDB.CHECK_PLUG_COMPATIBILITY(
          pdb_descr_file => '/disk1/usr/dv_db_pdb.xml',
          store_report   => TRUE)
    WHEN TRUE THEN 'YES'
    ELSE 'NO'
END;
BEGIN
  DBMS_OUTPUT.PUT_LINE(compatible);
END;
/
```

If the output is `YES`, then the PDB is compatible, and you can continue with the next step.

If the output is `NO`, then the PDB is not compatible. You can check the `PDB_PLUG_IN_VIOLATIONS` temporary table to see why it is not compatible.

8. Create an XML file that describes the PDB.

For example:

```
BEGIN
  DBMS_PDB.DESCRIBE(
    pdb_descr_file => '/disk1/oracle/dv_db.xml');
END;
/
```

9. Run the `CREATE PLUGGABLE DATABASE` statement, and specify the XML file in the `USING` clause. Specify other clauses when they are required.

For example:

```
CREATE PLUGGABLE DATABASE dv_db_pdb AS CLONE USING 'dv_db.xml' NOCOPY;
```

10. Connect to the PDB that you just created as user `SYS` with the `SYSDBA` administrative privilege.

```
CONNECT SYS@dv_db_pdb AS SYSDBA
```

11. Execute the `noncdb_to_pdb.sql` script.

```
@$ORACLE_HOME/rdbms/admin/noncdb_to_pdb.sql
```

12. Open this PDB in a read/write restricted mode.

```
ALTER PLUGGABLE DATABASE dv_db_pdb OPEN READ WRITE RESTRICTED;
```

13. Run the following procedure to synchronize the PDB:

```
EXECUTE DBMS_PDB.SYNC_PDB;
```

14. Connect to the root as a user who has been granted the `DV_OWNER` role.

```
sqlplus c##sec_admin  
Enter password: password
```

15. Revoke the `DV_PATCH_ADMIN` role from user `SYS` with `CONTAINER = CURRENT`.

```
REVOKE DV_PATCH_ADMIN FROM SYS CONTAINER = CURRENT;
```

16. Connect to the legacy Database Vault-enabled database as user `SYS` with the `SYSOPER` system privilege.

```
CONNECT SYS@dv_db_pdb AS SYSOPER
```

17. Restart this database.

For example:

```
SHUTDOWN IMMEDIATE  
STARUP
```

18. Revoke the `DV_PATCH_ADMIN` role from user `SYS`.

```
REVOKE DV_PATCH_ADMIN FROM SYS;
```

### Related Topics

- [Creating and Removing PDBs and Application Containers](#)  
You can create PDBs, application containers, and application seeds using a variety of techniques.

# 24

## Using XStream with a CDB

You can use Oracle Database XStream in a multitenant container database (CDB).

This chapter contains the following topics:

- [About XStream](#)  
XStream consists of Oracle Database components and application programming interfaces (APIs) that enable client applications to receive data changes from an Oracle database and send data changes to an Oracle database.
- [System-Created Rules and a Multitenant Environment](#)  
A multitenant environment enables an Oracle database to contain a portable set of schemas, objects, and related structures that appears logically to an application as a separate database. This self-contained collection is called a pluggable database (PDB). A CDB contains PDBs.
- [XStream Out and a Multitenant Environment](#)  
A multitenant environment enables a database to contain a portable set of schemas, objects, and related structures that appears logically to an application as a separate database.
- [Configuring XStream Out in a CDB](#)  
When you configure XStream Out in a CDB, you must decide which database changes will be captured by XStream Out and sent to the client application.
- [XStream In and a Multitenant Environment](#)  
A multitenant environment enables an Oracle database to contain a portable set of schemas, objects, and related structures that appears logically to an application as a separate database.

### 24.1 About XStream

XStream consists of Oracle Database components and application programming interfaces (APIs) that enable client applications to receive data changes from an Oracle database and send data changes to an Oracle database.

These data changes can be shared between Oracle databases and other systems. The other systems include non-Oracle databases, non-RDBMS Oracle products, file systems, third party software applications, and so on. A client application is designed by the user for specific purposes and use cases.

XStream consists of two major features: XStream Out and XStream In. **XStream Out** provides Oracle Database components and APIs that enable you to share data changes made to an Oracle database with other systems. XStream Out can retrieve both data manipulation language (DML) and data definition language (DDL) changes from the redo log and send these changes to a client application that uses the APIs, as shown in the following figure.

Figure 24-1 XStream Out

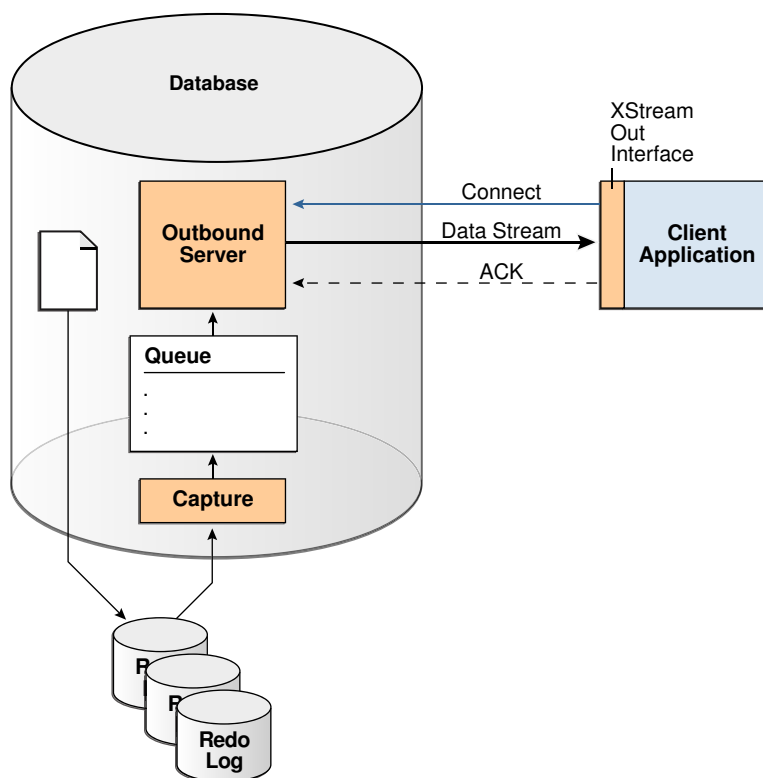

**XStream In** provides Oracle Database components and APIs that enable you to share data changes made to other systems with an Oracle database. XStream In can apply these changes to database objects in the Oracle database, as shown in the following figure.

Figure 24-2 XStream In

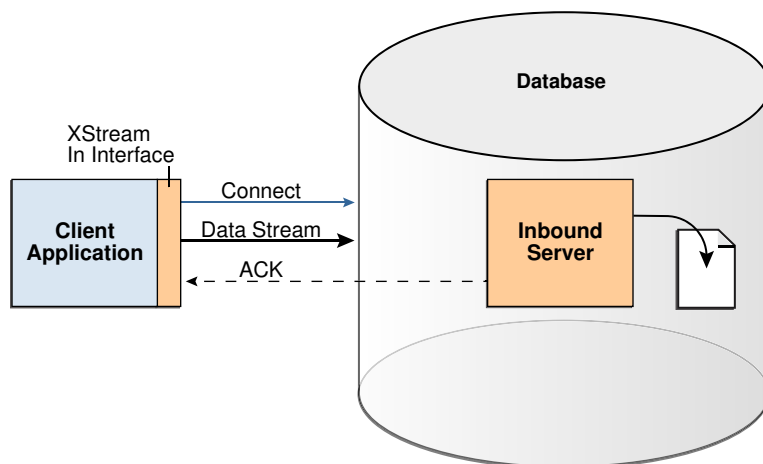

XStream uses the capture and apply features of the Oracle database. These features enable the following functionality for XStream:

- The logical change record (LCR) format for streaming database changes

An **LCR** is a message with a specific format that describes a database change. If the change was a data manipulation language (DML) operation, then a **row LCR** encapsulates each row change resulting from the DML operation. One DML operation might result in multiple row changes, and so one DML operation might result in multiple row LCRs. If the change was a data definition language (DDL) operation, then a single **DDL LCR** encapsulates the DDL change.
- Rules and rule sets that control behavior, including inclusion and exclusion rules

Rules enable the filtering of database changes at the database level, schema level, table level, and row/column level.
- Rule-based transformations that modify captured data changes
- Support for most data types in the database, including LOBs, LONG, LONG RAW, and XMLType
- Customized configurations, including multiple inbound streams to a single database instance, multiple outbound streams from a single database instance, multiple outbound streams from a single capture process, and so on
- Full-featured apply for XStream In, including apply parallelism for optimal performance, SQL generation, conflict detection and resolution, error handling, and customized apply with apply handlers

 **Note:**

In both XStream Out and XStream In configurations, the client application must use a dedicated server connection.

**Related Topics**

- *Oracle Database XStream Guide*

## 24.2 System-Created Rules and a Multitenant Environment

A multitenant environment enables an Oracle database to contain a portable set of schemas, objects, and related structures that appears logically to an application as a separate database. This self-contained collection is called a pluggable database (PDB). A CDB contains PDBs.

It can also contain application containers. An application container is an optional component of a CDB that consists of an application root and the application PDBs associated with it. An application container stores data for one or more applications. An application container shares application metadata and common data. In a CDB, each of the following is a container: the CDB root, each PDB, each application root, and each application PDB.

In a CDB, LCRs can contain the global name of the container where the change originated in the `source_database_name` attribute and the global name of the CDB root in the `root_name` attribute. The rules for XStream components can consider these attributes.

This section contains the following topics:

- [System-Created Rules in a CDB and XStream Out](#)  
In a CDB, XStream Out must be configured in the CDB root. Therefore, the PL/SQL procedures in the `DBMS_XSTREAM_ADM` package that create system-created rules must be run in the CDB root while connected as a common user.
- [System-Created Rules in a CDB and XStream In](#)  
You can configure XStream In in the root or in any container in a CDB.

### Related Topics

- [Multitenant Architecture](#)  
The **multitenant architecture** enables an Oracle database to function as a multitenant container database (CDB).

## 24.2.1 System-Created Rules in a CDB and XStream Out

In a CDB, XStream Out must be configured in the CDB root. Therefore, the PL/SQL procedures in the `DBMS_XSTREAM_ADM` package that create system-created rules must be run in the CDB root while connected as a common user.

Excluding the procedures that create rules for propagations, the procedures that create system-created rules for XStream Out, such as the `ADD_GLOBAL_RULES` procedure, include the key parameters in the following table:

**Table 24-1 Key Procedure Parameters for System-Created Rules in a CDB**

Parameter	Description
<code>source_database</code>	The global name of the source database. In a CDB, specify the global name of the container to which the rules pertain. The container can be the CDB root, a PDB, an application root, or an application PDB. The following are examples: <code>mycdb.example.com</code> or <code>hrpdb.example.com</code> .
<code>source_root_name</code>	The global name of the CDB root in the source CDB. The following are examples: <code>mycdb.example.com</code> .
<code>source_container_name</code>	The short name of the source container. The container can be the CDB root, a PDB, an application root, or an application PDB. The following are examples: <code>CDB\$ROOT</code> or <code>hrpdb</code> .

If you do not include the domain name when you specify `source_database` or `source_root_name`, then the procedure appends it to the name automatically. For example, if you specify `DBS1` and the domain is `.EXAMPLE.COM`, then the procedure specifies `DBS1.EXAMPLE.COM` automatically.

The combination of these key parameters determines which containers' changes XStream Out captures and streams to the client application, based on the rules generated by the procedures. Regardless of the settings for these parameters, system-generated rules can still limit the changes captured and streamed to specific schemas and tables.

Local capture means that a capture process runs on the source CDB. In a local capture configuration, the `source_root_name` parameter specifies the global name of the CDB root in the local CDB. If this parameter is `NULL`, then the global name of the CDB root in the local CDB is specified automatically. The resulting rules include a condition for the global name of the CDB root in the current CDB.



Downstream capture means that a capture process runs on a CDB other than the source CDB. In a downstream capture configuration, the `source_root_name` parameter must be non-NULL, and it must specify the global name of the CDB root in the remote source CDB. The resulting rules include a condition for the global name of the CDB root in the remote CDB. If this parameter is NULL, then local capture is assumed.

The following table describes the rule conditions for various `source_database` and `source_container_name` parameter settings in a local capture configuration.

**Table 24-2 Local Capture and XStream Out Container Rule Conditions**

<b>source_database Parameter Setting</b>	<b>source_container_name Parameter Setting</b>	<b>Description</b>
NULL	NULL	XStream Out captures and streams changes made in any container in the local CDB, including the CDB root, all PDBs, all application roots, and all application PDBs.
non-NULL	NULL	XStream Out captures and streams changes made in the specified source container of the local CDB. The source container can be the CDB root, a PDB, an application root, or an application PDB. The <code>DBMS_XSTREAM_ADM</code> procedure queries the <code>CDB_PDBS</code> view and <code>CDB_PROPERTIES</code> view to determine the <code>source_container_name</code> value.
NULL	non-NULL	XStream Out captures and streams changes made in the specified source container of the local CDB. The source container can be the CDB root, a PDB, an application root, or an application PDB. The <code>DBMS_XSTREAM_ADM</code> procedure queries the <code>CDB_PDBS</code> view and <code>CDB_PROPERTIES</code> view to determine the <code>source_database</code> value.
non-NULL	non-NULL	XStream Out captures and streams changes made in the specified source container of the local CDB. The source container can be the CDB root, a PDB, an application root, or an application PDB.  If the prefix of the <code>source_database</code> value is different from the <code>source_container_name</code> value, then the resulting rules include a condition for the <code>source_database</code> value, and an internal table maps the <code>source_database</code> value to the <code>source_container_name</code> value.

The following table describes the rule conditions for various `source_database` and `source_container_name` parameter settings in a downstream capture configuration.

**Table 24-3 Downstream Capture and XStream Out Container Rule Conditions**

<b>source_database Parameter Setting</b>	<b>source_container_n ame Parameter Setting</b>	<b>Description</b>
NULL	NULL	XStream Out captures and streams changes made in any container in the remote source CDB, including the CDB root, all PDBs, all application roots, and all application PDBs.
non-NULL	NULL	XStream Out captures and streams changes made in the specified source container of the remote source CDB. The source container can be the CDB root, a PDB, an application root, or an application PDB. The DBMS_XSTREAM_ADM procedure derives the source_container_name value from the prefix of source_database value.
NULL	non-NULL	The DBMS_XSTREAM_ADM procedure raises an error.
non-NULL	non-NULL	XStream Out captures and streams changes made in the specified source container of the remote source CDB. The source container can be the CDB root, a PDB, an application root, or an application PDB.  If the prefix of the source_database value is different from the source_container_name value, then the resulting rules include a condition for the source_database value, and an internal table maps the source_database value to the source_container_name value.

**Related Topics**

- *Oracle Database XStream Guide*
- *Oracle Database PL/SQL Packages and Types Reference*

## 24.2.2 System-Created Rules in a CDB and XStream In

You can configure XStream In in the root or in any container in a CDB.

Typically, an inbound server does not use rule sets or rules. Instead, it usually processes all LCRs that it receives from its client application. An inbound server can apply changes to the current container only. Therefore, if an inbound server is configured in the CDB root, then it can apply changes only to the CDB root. If an inbound server is configured in a PDB, then it can apply changes only to that PDB. If an inbound server is configured in an application root, then it can apply changes only to that application root, and if an inbound server is configured in an application PDB, then it can apply changes only to that application PDB.

### Related Topics

- [Administering a Multitenant Environment](#)  
You can administer a multitenant environment using SQL\*Plus or Enterprise Manager Cloud Control (Cloud Control).

## 24.3 XStream Out and a Multitenant Environment

A multitenant environment enables a database to contain a portable set of schemas, objects, and related structures that appears logically to an application as a separate database.

This self-contained collection is called a pluggable database (PDB). A multitenant container database (CDB) contains PDBs. In a CDB, XStream Out functions much the same as it does in a non-CDB.

A CDB can also contain application containers. An application container is an optional component of a CDB that consists of an application root and all application PDBs associated with it. An application container stores data for one or more applications. An application container shares application metadata and common data. In a CDB, each of the following is a container: the CDB root, each PDB, each application root, and each application PDB.

The main differences in the way XStream Out functions in a CDB and non-CDB are:

- XStream Out must be configured only in the CDB root.
- XStream Out can see changes made to any container within the CDB.
- XStream Out capture rules can limit the LCRs to those that are needed for the client application. The system-generated capture rules select the appropriate LCRs based on the parameters that were passed to the `ADD_OUTBOUND` and `CREATE_OUTBOUND` procedures in the `DBMS_XSTREAM_ADM` package. You can use the `ADD_*_RULES` procedures in the same package for more fine-grained control over the rules used by the XStream Out components.
- The user who performs XStream Out tasks must be a common user.

### Unplug and Plug Operations in an XStream Environment

When a PDB, application root, or application PDB involved with XStream Out is unplugged from its CDB and plugged into another CDB, any capture process or outbound server is not considered part of the container. You must configure the capture process and outbound server again in the other CDB.

If an outbound server is configured in a different database than the capture process, then unplug and plug operations have additional considerations.

For this example, assume the following:

- A CDB named `CDB1` contains PDB `PDB1`.
- A capture process is configured in `CDB1`, and it sends LCRs from `PDB1` to an outbound server in a CDB named `CDB2`.
- You unplug `PDB1` from `CDB1`, and then plug it into a CDB named `CDB3`.

To continue delivering LCRs from `PDB1` to the outbound server in `CDB2`, you must configure a new capture process in `CDB3` to capture and send LCRs to `CDB2`.

The rules used by the outbound server in database B must be altered to change references to the root of CDB1 to the root of CDB3. In addition, if PDB1 was given a different name in CDB3, then the rules must be altered to reflect the new PDB name.

### Application Containers in an XStream Environment

When a CDB has one or more application containers, XStream Out must be configured in the CDB root, and XStream Out can capture changes made in any container in the CDB, including the application roots and application PDBs. Changes captured in an application container can be sent to containers of any type, including PDBs, application roots, and application PDBs.

When replicating changes from one application root to another application root, XStream can replicate `ALTER PLUGGABLE DATABASE APPLICATION` statements. To avoid errors, the target application root that applies the statements must have the same application installed as the source application root, and the application name must be identical in both application roots.

To avoid errors when replicating changes from an application root to a container that is not an application root, you must ensure that `ALTER PLUGGABLE DATABASE APPLICATION` statements are not replicated.

With the XStream OCI API, you can control whether `ALTER PLUGGABLE DATABASE APPLICATION` statements are replicated using the `OCIXStreamOutAttach` function and the `OCILCRHeaderGet` function. With the XStream Java API, you can control this behavior using the `mode` parameter in the `XStreamOut.attach` method.

### Related Topics

- [System-Created Rules and a Multitenant Environment](#)  
A multitenant environment enables an Oracle database to contain a portable set of schemas, objects, and related structures that appears logically to an application as a separate database. This self-contained collection is called a pluggable database (PDB). A CDB contains PDBs.
- [Configuring XStream Out in a CDB](#)  
When you configure XStream Out in a CDB, you must decide which database changes will be captured by XStream Out and sent to the client application.
- [Multitenant Architecture](#)  
The **multitenant architecture** enables an Oracle database to function as a multitenant container database (CDB).

## 24.4 Configuring XStream Out in a CDB

When you configure XStream Out in a CDB, you must decide which database changes will be captured by XStream Out and sent to the client application.

XStream Out can stream all database changes for all containers, including the CDB root and all PDBs, application roots, and application PDBs, or XStream Out can stream the changes from specific containers. In addition, you can configure XStream Out with local capture, or you can configure it with downstream capture to offload the work required to capture changes from the source database.

The following restrictions apply when you configure XStream Out in a CDB:

- The capture process and outbound server must be in the CDB root.
- The capture process and outbound server must be in the same CDB.

- Each container in the CDB must be open during XStream Out configuration.
- When changes made to an application root are captured, you must ensure that `ALTER PLUGGABLE DATABASE APPLICATION` statements are replicated only to other application roots.

In addition, ensure that you create the XStream administrator properly for a CDB.

 **Note:**

When a container is created using a non-CDB, any XStream Out components from the non-CDB cannot be used in the container. You must drop and re-create the XStream Out components, including the capture process and outbound servers, in the CDB root.

This section contains the following topics:

- [Configuring XStream Out with Local Capture in a CDB](#)  
An example illustrates configuring XStream Out with local capture in a CDB.
- [Configuring XStream Out with Downstream Capture in CDBs](#)  
Using downstream capture, the XStream Out components can reside in databases other than the source database.

**Related Topics**

- [XStream Out and a Multitenant Environment](#)  
A multitenant environment enables a database to contain a portable set of schemas, objects, and related structures that appears logically to an application as a separate database.
- [System-Created Rules in a CDB and XStream Out](#)  
In a CDB, XStream Out must be configured in the CDB root. Therefore, the PL/SQL procedures in the `DBMS_XSTREAM_ADM` package that create system-created rules must be run in the CDB root while connected as a common user.
- *Oracle Database XStream Guide*
- [Options for Creating a PDB from a Non-CDB](#)  
You have multiple options for moving a non-CDB into a PDB.

## 24.4.1 Configuring XStream Out with Local Capture in a CDB

An example illustrates configuring XStream Out with local capture in a CDB.

**Prerequisites**

Before configuring XStream Out, ensure that all containers in the CDB are in open read/write mode during XStream Out configuration.

**Assumptions**

This section makes the following assumptions:

- The capture process will be a local capture process, and it will run on the same database as the outbound server.
- The name of the outbound server is `xout`.

- Data manipulation language (DML) and data definition language (DDL) changes made to the `oe.orders` and `oe.order_items` tables in PDB `pdb1.example.com` are sent to the outbound server.
- DML and DDL changes made to the `hr` schema in the PDB `pdb1.example.com` are sent to the outbound server.

Figure 24-3 provides an overview of this XStream Out configuration.

**Figure 24-3 Sample XStream Out Configuration Created Using CREATE\_OUTBOUND for a PDB**

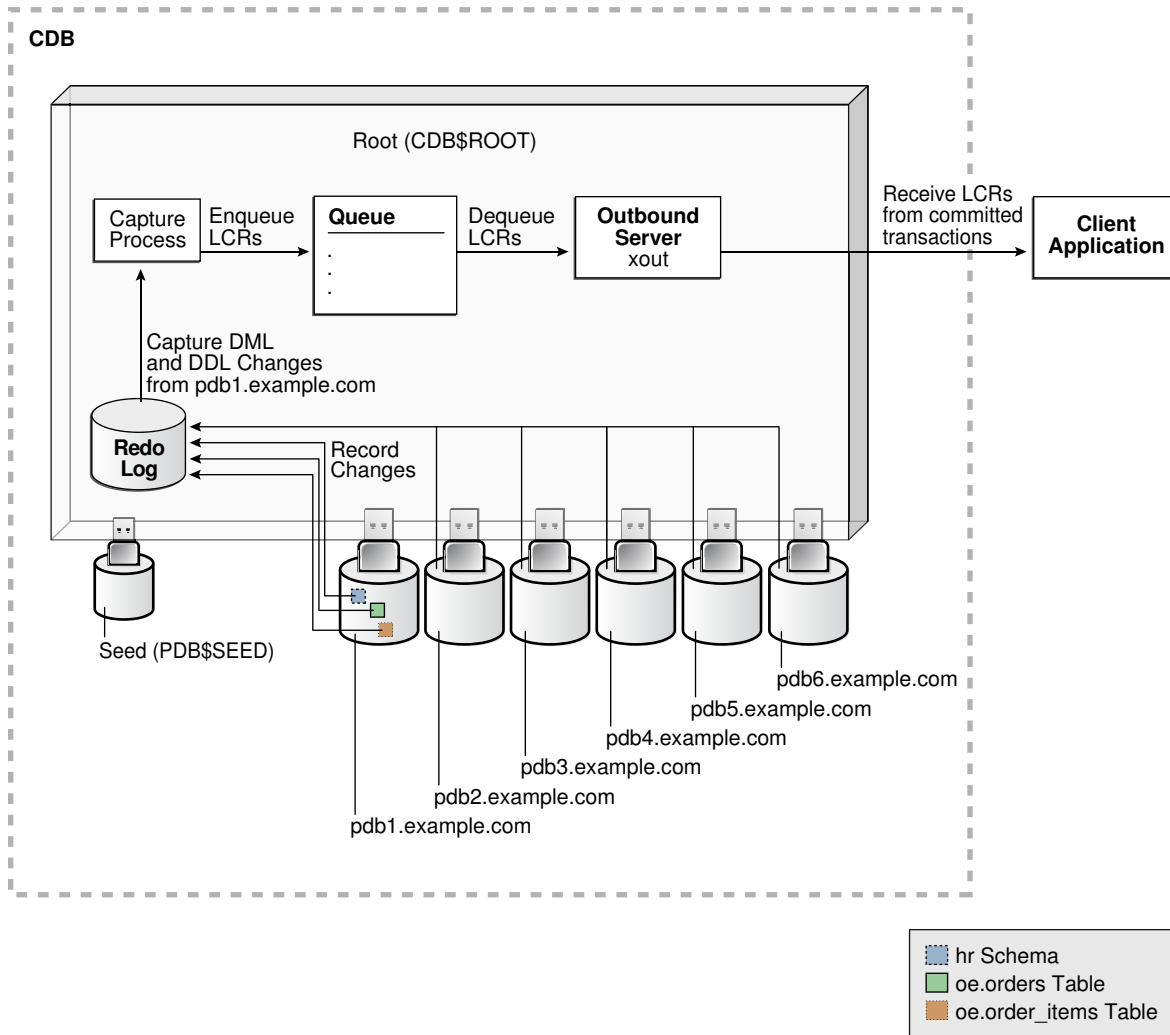

**To create an outbound server using the CREATE\_OUTBOUND procedure:**

1. In SQL\*Plus, connect to the root in the CDB (not to the PDB `pdb1.example.com`) as the XStream administrator.
2. Create the outbound server and other XStream components.
  - a. Ensure that all containers in the source CDB are in open read/write mode.
  - b. Run the `CREATE_OUTBOUND` procedure.

Given the assumptions for this example, run the following `CREATE_OUTBOUND` procedure:

```
DECLARE
  tables DBMS_UTILITY.UNCL_ARRAY;
  schemas DBMS_UTILITY.UNCL_ARRAY;
BEGIN
  tables(1) := 'oe.orders';
  tables(2) := 'oe.order_items';
  schemas(1) := 'hr';
  DBMS_XSTREAM_ADM.CREATE_OUTBOUND(
    server_name      => 'xout',
    source_database => 'pdb1.example.com',
    table_names     => tables,
    schema_names    => schemas);
END;
/
```

 **Note:**

To capture changes in all containers in a CDB, including the CDB root, all PDBs, all application roots, and all application PDBs, and send those changes to the XStream client application, you can omit the `source_database` parameter when you run the `CREATE_OUTBOUND` procedure.

- c. After the `CREATE_OUTBOUND` procedure completes successfully, optionally change the open mode of one or more containers if necessary.

Running the procedure in Step **b** performs the following actions:

- Configures supplemental logging for the `oe.orders` and `oe.order_items` tables and for all tables in the `hr` schema in the `pdb1.example.com` PDB.
- Creates a queue with a system-generated name that is used by the capture process and the outbound server.
- Creates and starts a capture process with a system-generated name with rule sets that instruct it to capture DML and DDL changes to the `oe.orders` table, the `oe.order_items` table, and the `hr` schema from the `pdb1.example.com` PDB.
- Creates and starts an outbound server named `xout` with rule sets that instruct it to send DML and DDL changes to the `oe.orders` table, the `oe.order_items` table, and the `hr` schema to the client application.
- Sets the current user as the connect user for the outbound server. In this example, the current user is the XStream administrator. The client application must connect to the database as the connect user to interact with the outbound server.

 **Note:**

The `server_name` value cannot exceed 30 bytes.

 **Tip:**

To capture and send all database changes from the `pdb1.example.com` database to the outbound server, specify `NULL` (the default) for the `table_names` and `schema_names` parameters.

3. Create and run the client application that will connect to the outbound server in the root of the CDB and receive the LCRs.

When you run the client application, the outbound server is started automatically.

#### Related Topics

- *Oracle Database XStream Guide*
- *Oracle Database XStream Guide*

## 24.4.2 Configuring XStream Out with Downstream Capture in CDBs

Using downstream capture, the XStream Out components can reside in databases other than the source database.

When you have multiple CDBs, the source database can be in one CDB, and you can use downstream capture to capture the changes in another CDB.

#### Prerequisites

Before configuring XStream Out, the following prerequisites must be met:

- Ensure that all containers in the CDB are in open read/write mode during XStream Out configuration.
- This example uses downstream capture. Therefore, you must configure log file transfer from the source database to a downstream database.
- If you want to use real-time downstream capture, then you must also add the required standby redo logs.

#### Assumptions

This section makes the following assumptions:

- The name of the outbound server is `xout`.
- The queue used by the outbound server is `c##xstrmadmin.xstream_queue`.
- The source database is the PDB `pdb1.example.com` in the CDB `data.example.com`.
- The capture process runs in the CDB `capture.example.com`.
- The outbound server runs in the CDB `capture.example.com`.



- DML and DDL changes made to the `oe.orders` and `oe.order_items` tables from the PDB `pdb1.example.com` are sent to the outbound server.
- DML and DDL changes made to the `hr` schema from the PDB `pdb1.example.com` are sent to the outbound server.

The following figure gives an overview of this XStream Out configuration.

Figure 24-4 Sample XStream Out Configuration Using Multiple CDBs and Downstream Capture

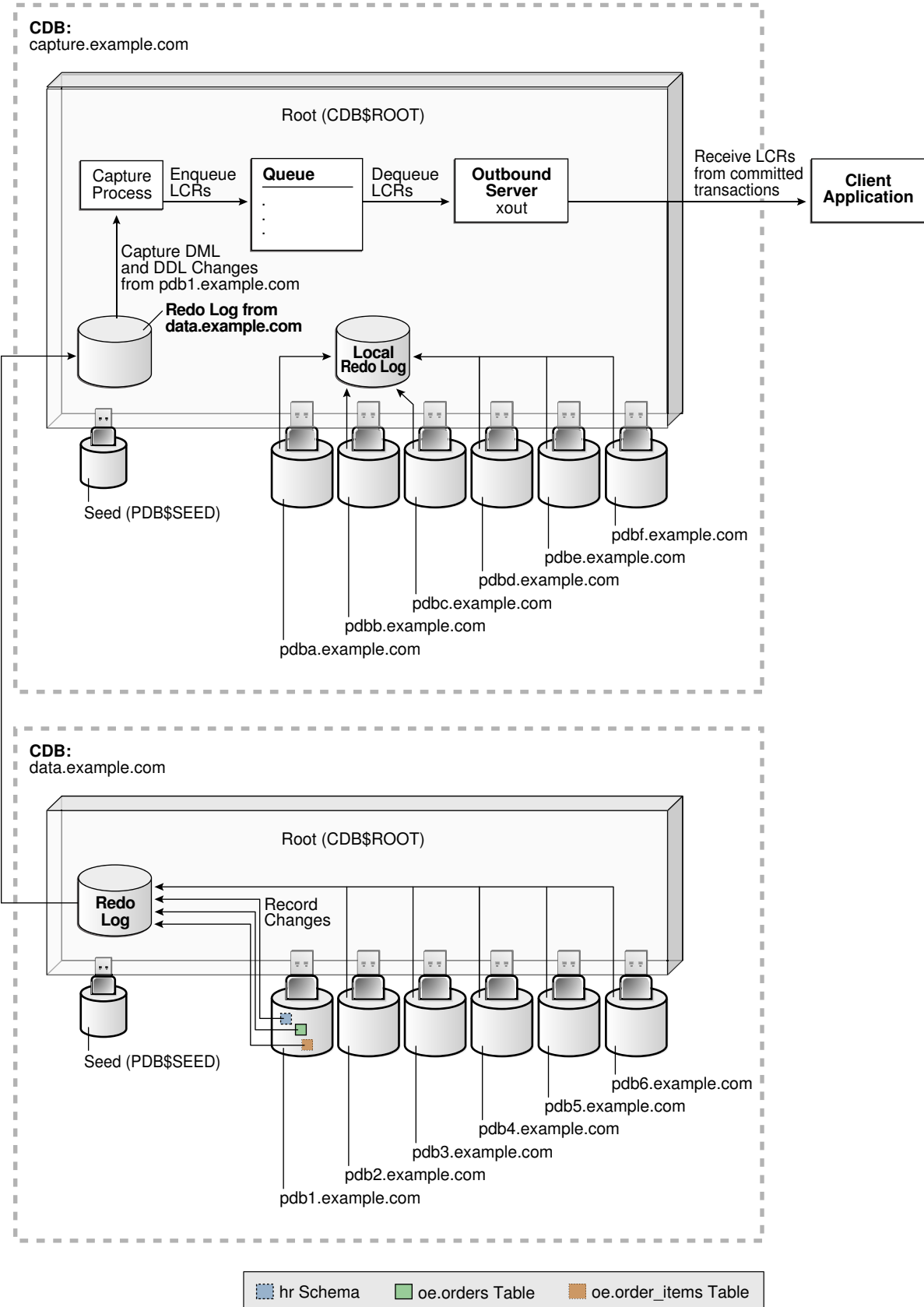

**To configure XStream Out with downstream capture in CDBs:**

1. In SQL\*Plus, connect to the root of the downstream capture CDB as the XStream administrator.

In this example, the downstream capture CDB is `capture.example.com`.

2. Create the queue that will be used by the capture process.

For example, run the following procedure:

```
BEGIN
  DBMS_XSTREAM_ADM.SET_UP_QUEUE(
    queue_table => 'c##xstrmadmin.xstream_queue_table',
    queue_name  => 'c##xstrmadmin.xstream_queue');
END;
/
```

3. Optionally, create the database link from the root in the downstream capture CDB to the root in the source CDB.

In this example, create a database link from the root in `capture.example.com` to the root in `data.example.com`. For example, if the user `c##xstrmadmin` is the XStream administrator on both databases, then create the following database link:

```
CREATE DATABASE LINK data.example.com CONNECT TO c##xstrmadmin
  IDENTIFIED BY password USING 'data.example.com';
```

4. Ensure that all containers in the source CDB are in open read/write mode.
5. If you did not create the database link in Step 3, then you must complete additional steps in the root of the source CDB.

These steps are not required if you created the database link in Step 3.

Run the `BUILD` procedure and ensure that required supplemental logging is specified for the database objects in the source CDB:

- a. Connect to the root in the source CDB as the XStream administrator.
- b. Run the `DBMS_CAPTURE_ADM.BUILD` procedure. For example:

```
SET SERVEROUTPUT ON
DECLARE
  scn NUMBER;
BEGIN
  DBMS_CAPTURE_ADM.BUILD(
    first_scn => scn);
  DBMS_OUTPUT.PUT_LINE('First SCN Value = ' || scn);
END;
/
First SCN Value = 409391
```

This procedure displays the valid first SCN value for the capture process that will be created in the root in the `capture.example.com` CDB. Make a note of the SCN value returned because you will use it when you create the capture process in Step 6.

- c. Ensure that required supplemental logging is specified for the database objects in the source CDB.

For this example, ensure that supplemental logging is configured for the `hr` schema, the `oe.orders` table, and the `oe.order_items` table in the `pdbl.example.com` PDB.

6. While connected to the root in the downstream capture CDB, create the capture process.

For example, run the following procedure to create the capture process while connected as the XStream administrator to `capture.example.com`:

```
BEGIN
  DBMS_CAPTURE_ADM.CREATE_CAPTURE(
    queue_name      => 'c##xstrmadmin.xstream_queue',
    capture_name    => 'real_time_capture',
    rule_set_name   => NULL,
    start_scn       => NULL,
    source_database => NULL,
    use_database_link => TRUE,
    first_scn       => NULL,
    logfile_assignment => 'implicit',
    source_root_name => 'data.example.com',
    capture_class   => 'xstream');
END;
/
```

If you did not create a database link in Step 3, then specify the SCN value returned by the `DBMS_CAPTURE_ADM.BUILD` procedure for the `first_scn` parameter.

Do not start the capture process.

7. After the capture process is created, optionally change the open mode of one or more PDBs if necessary.
8. Run the `ADD_OUTBOUND` procedure.

Given the assumption for this section, run the following `ADD_OUTBOUND` procedure:

```
DECLARE
  tables DBMS_UTILITY.UNCL_ARRAY;
  schemas DBMS_UTILITY.UNCL_ARRAY;
BEGIN
  tables(1) := 'oe.orders';
  tables(2) := 'oe.order_items';
  schemas(1) := 'hr';
  DBMS_XSTREAM_ADM.ADD_OUTBOUND(
    server_name      => 'xout',
    queue_name       => 'c##xstrmadmin.xstream_queue',
    source_database  => 'pdbl.example.com',
    table_names      => tables,
    schema_names     => schemas,
    source_root_name => 'data.example.com',
    source_container_name => 'pdbl');
END;
/
```

Running this procedure performs the following actions:

- Creates an outbound server named `xout`. The outbound server has rule sets that instruct it to send DML and DDL changes to the `oe.orders` table, the `oe.order_items` table, and the `hr` schema to the client application. The rules specify that these changes must have originated at the PDB `pdbl.example.com` in the CDB `data.example.com`. The outbound server dequeues LCRs from the queue `c##xstrmadmin.xstream_queue`.
- Sets the current user as the `connect_user` for the outbound server. In this example, the `current_user` is the XStream administrator. The client application must connect to the database as the `connect_user` to interact with the outbound server.

 **Note:**

The `server_name` value cannot exceed 30 bytes.

9. Create and run the client application that will connect to the outbound server and receive the LCRs.

When you run the client application, the outbound server is started automatically at the downstream capture CDB.

#### Related Topics

- *Oracle Database XStream Guide*

## 24.5 XStream In and a Multitenant Environment

A multitenant environment enables an Oracle database to contain a portable set of schemas, objects, and related structures that appears logically to an application as a separate database.

This self-contained collection is called a pluggable database (PDB). A multitenant container database (CDB) contains PDBs. It can also contain application containers. An application container is an optional component of a CDB that consists of an application root and all application PDBs associated with it. An application container stores data for one or more applications. An application container shares application metadata and common data. In a CDB, each of the following is a container: the CDB root, each PDB, each application root, and each application PDB.

In a CDB, the inbound server is restricted to receiving LCRs from one source database and only executing changes in the current container (one PDB, one application root, one application PDB, or the CDB root). A single inbound server cannot apply changes to more than one container in a CDB.

When the inbound server is in the CDB root, the apply user must be a common user. When the inbound server is in an application root, the apply user must be a common user or an application common user. When the inbound server is in a PDB or application PDB, the apply user can be a common user or a local user.

 **Note:**

XStream does not synchronize changes done in the application root container. Do not use the XStream In replication to replicate operations done in the application root container. You can manually apply these changes in the application root containers in the target. Note that the operations done in the PDBs can still be replicated.

### Related Topics

- [System-Created Rules and a Multitenant Environment](#)  
A multitenant environment enables an Oracle database to contain a portable set of schemas, objects, and related structures that appears logically to an application as a separate database. This self-contained collection is called a pluggable database (PDB). A CDB contains PDBs.
- [Multitenant Architecture](#)  
The **multitenant architecture** enables an Oracle database to function as a multitenant container database (CDB).

# Part VI

## Administering a Multitenant Environment with Cloud Control

You can create, configure, and administer a multitenant environment using Oracle Enterprise Manager Cloud Control (Cloud Control).

This part contains the following chapters:

- [Logging into a Multitenant Environment in Enterprise Manager](#)  
In a multitenant environment, you can log in to a CDB or a PDB, and switch from a PDB to a different PDB or to the root.
- [Creating and Removing PDBs with Cloud Control](#)  
You can you can create, clone, unplug, and remove pluggable databases (PDBs) in a multitenant container database (CDB) using Oracle Enterprise Manager Cloud Control (Cloud Control).
- [Administering CDBs and PDBs with Cloud Control](#)  
You can administer CDBs and PDBs with Oracle Enterprise Manager Cloud Control.
- [Using Oracle Resource Manager for PDBs with Cloud Control](#)  
You can use Oracle Resource Manage for a multitenant environment with Oracle Enterprise Manager Cloud Control.
- [Managing Security for a Multitenant Environment in Enterprise Manager](#)  
You can manage common and local users and roles for a multitenant environment by using Oracle Enterprise Manager.

# Logging into a Multitenant Environment in Enterprise Manager

In a multitenant environment, you can log in to a CDB or a PDB, and switch from a PDB to a different PDB or to the root.

This section contains the following topics:

- [Logging into a CDB or a PDB](#)  
Different variations of the Enterprise Manager Database login page appear automatically based on the feature that you requested while logging in.
- [Switching to a Different PDB or to the Root](#)  
From Oracle Enterprise Manager, you can switch from one PDB to a different PDB, or to the root.

## 25.1 Logging into a CDB or a PDB

Different variations of the Enterprise Manager Database login page appear automatically based on the feature that you requested while logging in.

To log into a multitenant environment as a CDB administrator (an Enterprise Manager user who has the `CONNECT` privilege on the CDB target) to use a CDB-scoped feature:

1. Log into Oracle Enterprise Manager Cloud Control as either user `SYSTEM` or `SYSMAN`.

The URL is as follows:

```
https://host:port/em
```

2. Navigate to the Databases page.
3. Select the database that you want to access.

The database home page appears.

4. Select the menu item for the action that you want to perform, such as selecting **Administration**, then **Security**, and then **Users** to authenticate a user.

The Database Login page appears. The following example shows the Database Login page for the CDB (because the database name is shown as `CDB$ROOT`). Because of this name, this page is colloquially referred to as the database login page for the `root` of the multitenant environment. The **Database** field refers to the current database; had you selected a PDB, then the name of the PDB would appear in this field.





5. Log in using the appropriate credentials.

Remember that only common users can log into the root, and that the names of common users begin with c## or c###. Both common and local users can log into a PDB, depending on their privileges.

## 25.2 Switching to a Different PDB or to the Root

From Oracle Enterprise Manager, you can switch from one PDB to a different PDB, or to the root.

1. At the top left side of the page, find the **database** link.

In the **database** link, the current container name appears. The following example shows that the current database is the CDB itself (CDB\$ROOT), colloquially known as the root.

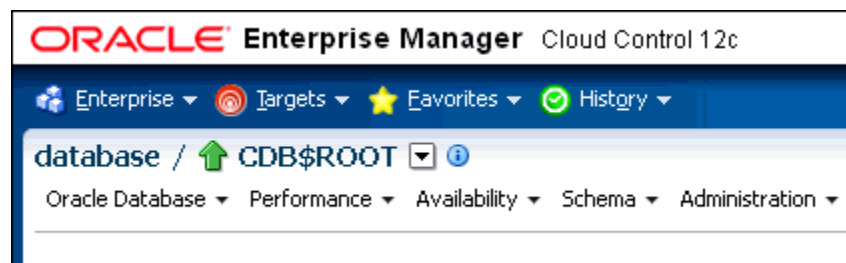

2. Select the menu icon to the right of the container, and from this menu, select the database that you want to access.

If the menu item does not appear, then navigate to a page where it does appear, such as the Database home page.

3. When you decide which activity you want to perform (such as creating users), log in with the appropriate privileges.

If you attempt to perform an activity without first having authenticated with the appropriate privileges, then you will be prompted to log in with the appropriate privilege.

# Creating and Removing PDBs with Cloud Control

You can create, clone, unplug, and remove pluggable databases (PDBs) in a multitenant container database (CDB) using Oracle Enterprise Manager Cloud Control (Cloud Control).

This section contains the following topics:

- [Getting Started with Creating and Removing PDBs with Cloud Control](#)  
You follow specific steps when you create a new PDB, clone a PDB, migrate a non-CDB as a PDB, unplug a PDB, and delete a PDB.
- [Overview of Creating and Removing PDBs with Cloud Control](#)  
Cloud Control enables administrators to manage the entire PDB lifecycle.
- [Provisioning a PDB with Cloud Control](#)  
You can provision PDBs by creating a new PDB within a CDB, by cloning an existing PDB, or by migrating existing non-CDBs to a CDB as PDBs. You can also use unplugged PDBs for provisioning, by plugging them into a CDB.
- [Removing PDBs with Cloud Control](#)  
You can unplug and delete PDBs.
- [Viewing PDB Job Details with Cloud Control](#)  
You can view the details of the jobs that are created by the Enterprise Manager job system when you create a PDB, unplug a PDB, or delete a PDB.

## See Also:

- ["Overview of PDB Creation"](#)
- ["General Prerequisites for PDB Creation"](#)

## 26.1 Getting Started with Creating and Removing PDBs with Cloud Control

You follow specific steps when you create a new PDB, clone a PDB, migrate a non-CDB as a PDB, unplug a PDB, and delete a PDB.

The following table provides a documentation map to understand the sequence of actions you must perform to successfully complete these tasks using Cloud Control. Click the reference links provided against the steps to reach the relevant topics that provide more information.

**Table 26-1 Getting Started with PDBs**

Step	Description	Reference Links
<b>Step 1</b>	<b>Obtaining an Overview</b> Obtain a conceptual overview of PDBs.	To obtain a conceptual overview of PDBs, see " <a href="#">Overview</a> ". For detailed conceptual information, see " <a href="#">Overview of Managing a Multitenant Environment</a> " and <i>Oracle Database Concepts</i>
<b>Step 2</b>	<b>Selecting the Use Case</b> Among the following use cases, select the one that best matches your requirement: <ul style="list-style-type: none"> <li>• Creating a new PDB</li> <li>• Plugging in an unplugged PDB</li> <li>• Cloning a PDB</li> <li>• Migrating a non-CDB as a PDB</li> <li>• Unplugging and dropping a PDB</li> <li>• Deleting PDBs</li> </ul>	
<b>Step 3</b>	<b>Meeting the Prerequisites</b> Meet the prerequisites for the selected use case.	<ul style="list-style-type: none"> <li>• To meet the prerequisites for creating a new PDB, see "<a href="#">Prerequisites</a>".</li> <li>• To meet the prerequisites for plugging in an unplugged PDB, see "<a href="#">Prerequisites</a>".</li> <li>• To meet the prerequisites for cloning a PDB, see "<a href="#">Prerequisites</a>".</li> <li>• To meet the prerequisites for migrating a non-CDB to a PDB, see "<a href="#">Prerequisites</a>".</li> <li>• To meet the prerequisites for unplugging and dropping a PDB, see "<a href="#">Prerequisites</a>".</li> <li>• To meet the prerequisites for deleting PDBs, see "<a href="#">Prerequisites</a>".</li> </ul>
<b>Step 4</b>	<b>Following the Procedure</b> Follow the procedure for the selected use case.	<ul style="list-style-type: none"> <li>• To create a new PDB, see "<a href="#">Procedure</a>".</li> <li>• To plug in an unplugged PDB, see "<a href="#">Procedure</a>".</li> <li>• To clone a PDB, see "<a href="#">Procedure</a>".</li> <li>• To migrate a non-CDB to a PDB, see "<a href="#">Procedure</a>".</li> <li>• To unplug and drop a PDB, see "<a href="#">Procedure</a>".</li> <li>• To delete PDBs, see "<a href="#">Procedure</a>".</li> </ul>

## 26.2 Overview of Creating and Removing PDBs with Cloud Control

Cloud Control enables administrators to manage the entire PDB lifecycle.

The lifecycle includes the following tasks:

- Provisioning CDBs

- Provisioning PDBs (from the seed or from an unplugged PDB)
- Cloning existing PDBs
- Migrating non-CDBs as PDBs
- Unplugging PDBs
- Deleting PDBs

 **Note:**

To manage the PDB lifecycle using Cloud Control, you must have the 12.1.0.3 Enterprise Manager for Oracle Database plug-in, or a later version, deployed. To delete PDBs using Cloud Control, you must have the 12.1.0.5 Enterprise Manager for Oracle Database plug-in deployed.

The following figure provides a graphical overview of how you can manage the PDB lifecycle in Cloud Control.

**Figure 26-1 Managing PDBs**

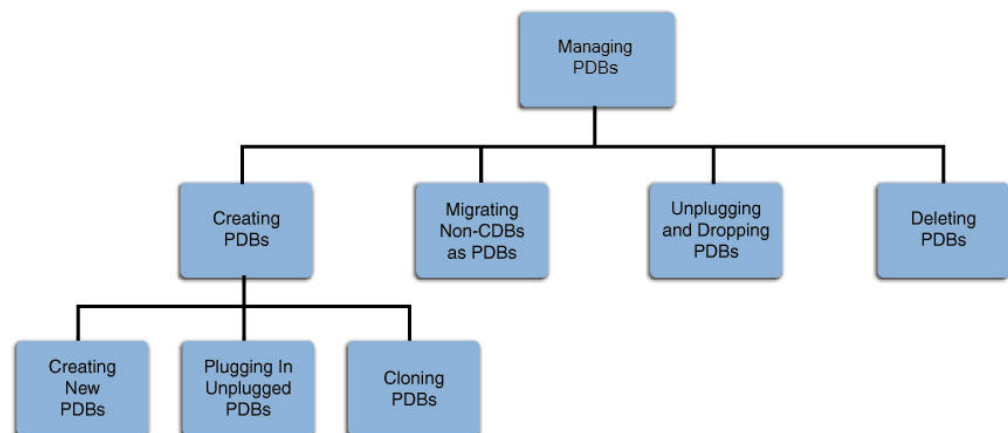

## 26.3 Provisioning a PDB with Cloud Control

You can provision PDBs by creating a new PDB within a CDB, by cloning an existing PDB, or by migrating existing non-CDBs to a CDB as PDBs. You can also use unplugged PDBs for provisioning, by plugging them into a CDB.

 **Note:**

As an alternative to using the methods described in this section, you can use Enterprise Manager Command Line Interface (EM CLI) to provision PDBs.

This section contains the following topics:

- [Creating a New PDB with Cloud Control](#)  
You can create a new PDB in a CDB.
- [Plugging In an Unplugged PDB with Cloud Control](#)  
You can plug an unplugged PDB into a CDB.
- [Cloning a PDB with Cloud Control](#)  
You can clone a PDB using either the Full Clone method, or the Snap Clone method.
- [Migrating a Non-CDB to a PDB with Cloud Control](#)  
You can migrate a non-CDB to a PDB.

## 26.3.1 Creating a New PDB with Cloud Control

You can create a new PDB in a CDB.

This section contains the following topics:

- [Prerequisites](#)  
Prerequisites must be met when creating a new PDB.
- [Procedure](#)  
Follow these steps to create a new PDB in a CDB.

### 26.3.1.1 Prerequisites

Prerequisites must be met when creating a new PDB.

- Oracle Software Library (Software Library) must be set up in Cloud Control.
- The CDB within which you want to create a PDB must exist, and must be a Cloud Control target.
- The CDB (within which you want to create a PDB) must be in read/write mode.
- The target host user must be the owner of the Oracle Home that the CDB (within which you want to create the PDB) belongs to.

### 26.3.1.2 Procedure

Follow these steps to create a new PDB in a CDB.

1. From the **Enterprise** menu, select **Provisioning and Patching**, then select **Database Provisioning**. In the Database Provisioning page, in the Related Links section of the left menu pane, click **Provision Pluggable Databases**.

 **Note:**

You can also access the Provision Pluggable Database Console from the Home page of the CDB. To do so, in the CDB's Home page, from the **Oracle Database** menu, select **Provisioning**, then select **Provision Pluggable Database**.

2. In the Provision Pluggable Database Console, in the Container Database section, select the CDB within which you want to create new PDBs.

 **Note:**

Skip this step if you have accessed the Provision Pluggable Database Console from the CDB's Home page.

3. In the PDB Operations section, select **Create New Pluggable Databases**.
4. Click **Launch**.

 **Note:**

You will be prompted to log in to the database if you have not already logged in to it through Enterprise Manager. Make sure you log in using SYSDBA user account credentials.

5. In the Creation Options page of the Create Pluggable Database Wizard, in the Pluggable Database Creation Options section, select **Create a New PDB**.
6. In the Container Database Host Credentials section, select or specify the target CDB Oracle Home owner host credentials. If you have already registered the credentials with Enterprise Manager, then you can select **Preferred** or **Named**. Otherwise, you can select **New** and enter the credentials.
7. Click **Next**.
8. In the Identification page, enter a unique name for the PDB you are creating.  
If you prefer to create more than one PDB in this procedure, then select **Create Multiple Copies**, and set the number of PDBs you want to create. Note that you can create a maximum of 252 PDBs.

 **Note:**

If you choose to create multiple PDBs, then the unique name you enter here is used as a prefix for all PDBs, and the suffix is a numeric value that indicates the count of PDBs.

For example, if you create five PDBs with the name `accountsPDB`, then the PDBs are created with the names `accountsPDB1`, `accountsPDB2`, `accountsPDB3`, `accountsPDB4`, and `accountsPDB5`.

9. In the PDB Administrator section, enter the credentials of the admin user account you need to create for administering the PDB.

 **Note:**

If you choose to create multiple PDBs, then an admin user account is created for each PDB that you create, with the same set of the specified credentials.

10. Click **Next**.

11. In the Storage page, in the PDB Datafile Locations section, select the type of location where you want to store the datafiles.
  - If the target CDB (*CDB in which you are creating the PDB*) is enabled with Oracle Managed Files and if you want to use the same, then select **Use Oracle Managed Files (OMF)**.
  - If you want to enter a custom location, then select **Use Common Location for PDB Datafiles**. Select the storage type and the location where the datafiles can be stored.
12. In the Temporary Working Directory section, enter a location where the temporary files generated during the PDB creation process can be stored.
13. In the Post-Creation Scripts section, select a custom SQL script you want to run as part of this procedure, once the PDB is created.
14. Click **Next**.
15. In the Schedule page, enter a unique deployment procedure instance name and a schedule for the deployment. The instance name you enter here helps you identify and track the progress of this procedure on the Procedure Activity page.

If you want to run the procedure immediately, then retain the default selection, that is, **Immediately**. Otherwise, select **Later** and provide time zone, start date, and start time details.

You can optionally set a grace period for this schedule. A grace period is a period of time that defines the maximum permissible delay when attempting to run a scheduled procedure. If the procedure does not start within the grace period you have set, then the procedure skips running. To set a grace period, select **Grace Period**, and set the permissible delay time.
16. Click **Next**.
17. In the Review page, review the details you have provided for the deployment procedure. If you are satisfied with the details, click **Submit**.

If you want to modify the details, then click **Back** repeatedly to reach the page where you want to make the changes.
18. In the Procedure Activity page, view the status of the procedure. From the **Procedure Actions** menu, you can select **Debug** to set the logging level to Debug, and select **Stop** to stop the procedure execution.

When you create a new PDB, the Enterprise Manager job system creates a Create Pluggable Database job. For information about viewing the details of this job, refer "[Viewing Create PDB Job Details](#)".

## 26.3.2 Plugging In an Unplugged PDB with Cloud Control

You can plug an unplugged PDB into a CDB.

This section contains the following topics:

- [Prerequisites](#)  
Prerequisites must be met when plugging an unplugged PDB.
- [Procedure](#)  
Follow these steps to plug an unplugged PDB into a CDB.



## 26.3.2.1 Prerequisites

Prerequisites must be met when plugging an unplugged PDB.

- Oracle Software Library (Software Library) must be set up in Cloud Control.  
For information on how to set up Software Library in Cloud Control, see *Oracle Enterprise Manager Lifecycle Management Administrator's Guide*.
- The target CDB (the CDB within which you want to plug in the unplugged PDB) must exist, and must be a Cloud Control target.
- The target CDB must be in read/write mode.
- The XML file that describes the unplugged PDB, and the other files associated with the unplugged PDB, such as the data files, must exist and must be readable.
- The target host user must be the owner of the Oracle Home that the CDB (into which you want to plug the unplugged PDB) belongs to.
- The platforms of the source CDB host (the host on which the CDB that previously contained the unplugged PDB is installed) and the target CDB host (the host on which the target CDB is installed) must have the same endianness.
- The database options installed on the source platform must be the same as, or a subset of, the database options installed on the target platform.
- If the character set of the CDB to which the PDB is being cloned is not AL32UTF8, then the CDB that contained the unplugged PDB and the target CDB must have compatible character sets and national character sets. To be compatible, the character sets and national character sets must meet all requirements specified in *Oracle Database Globalization Support Guide*.

If the character set of the CDB to which the PDB is being cloned is AL32UTF8, then this requirement does not apply.

- If you are creating an application PDB, then the application name and version of the unplugged PDB must match the application name and version of the application container that will contain the application PDB when it is plugged in.
- If you are creating an application PDB, then the application PDB must have the same character set and national character set as the application container.

If the database character set of the CDB is AL32UTF8, then the character set and national character set of the application container can differ from the CDB. However, all application PDBs in an application container must have the same character set and national character set, matching that of the application container.

## 26.3.2.2 Procedure

Follow these steps to plug an unplugged PDB into a CDB.

1. From the **Enterprise** menu, select **Provisioning and Patching**, then select **Database Provisioning**. In the Database Provisioning page, in the Related Links section of the left menu pane, click **Provision Pluggable Databases**.

 **Note:**

You can also access the Provision Pluggable Database Console from the Home page of the CDB. To do so, in the CDB's Home page, from the **Oracle Database** menu, select **Provisioning**, then select **Provision Pluggable Database**.

2. In the Provision Pluggable Database Console, in the Container Database section, select the CDB to which you want to add the unplugged PDBs.

 **Note:**

Skip this step if you have accessed the Provision Pluggable Database Console from the CDB's Home page.

3. In the PDB Operations section, select **Create New Pluggable Databases**.
4. Click **Launch**.

 **Note:**

You will be prompted to log in to the database if you have not already logged in to it through Enterprise Manager. Make sure you log in using SYSDBA user account credentials.

5. In the Creation Options page of the Create Pluggable Database Wizard, in the Pluggable Database Creation Options section, select **Plug an Unplugged PDB**.
6. In the Container Database Host Credentials section, select or specify the target CDB Oracle Home owner host credentials. If you have already registered the credentials with Enterprise Manager, then you can select **Preferred** or **Named**. Otherwise, you can select **New** and enter the credentials.
7. Click **Next**.
8. In the Identification page, enter a unique name for the PDB you are plugging in.  
Select **Create As Clone** if you are plugging a PDB into a CDB that contains one or more PDBs that were created by plugging in the same PDB. Selecting this option ensures that Oracle Database generates unique PDB DBID, GUID, and other identifiers expected for the new PDB.  
If you prefer to create more than one PDB in this procedure, then select **Create Multiple Copies**, and set the number of PDBs you want to create. Note that you can create a maximum of 252 PDBs.

 **Note:**

If you choose to create multiple PDBs, then the unique name you enter here is used as a prefix for all PDBs, and the suffix is a numeric value that indicates the count of PDBs.

For example, if you create five PDBs with the name `accountsPDB`, then the PDBs are created with the names `accountsPDB1`, `accountsPDB2`, `accountsPDB3`, `accountsPDB4`, and `accountsPDB5`.

9. In the PDB Administrator section, do one of the following to administer the PDB:
  - If you prefer to use the admin user account that was created as part of the source PDB that you are plugging in, then deselect **Create PDB Administrator**.
  - If you want to create a new admin user account for the PDB you are plugging in, then select **Create PDB Administrator**, and enter the desired credentials.

 **Note:**

If you choose to create multiple PDBs, then an admin user account is created for each PDB that you create, with the same set of the specified credentials.

To lock and expire all the users in the newly created PDB, (except the newly created Admin), select **Lock All Existing PDB Users**.

10. In the PDB Template Location section, select the location where the source PDB's template is available, and then select the type of PDB template.
  - If the PDB template is available on your CDB host (*CDB to which you are plugging in the unplugged PDB*), then select **Target Host File System**.
    - If the PDB template is a single archive file—a TAR file with data files and metadata XML file included in it, then select **Create Pluggable Database from Pluggable Database Archive**, then select the PDB template.
    - If the PDB template is a PDB file set—a separate DFB file with all the data files and a separate metadata XML file, then select **Create the PDB using PDB File Set**, then select the DBF and XML files.
    - If you want to plug in a PDB using the PDB metadata XML file and the existing data files, then select **Create PDB using Metadata file**.
  - If the PDB template is available in Oracle Software Library (Software Library), then select **Software Library**, then select the component in the Software Library that contains the PDB template.
11. Click **Next**.
12. In the Storage page, do one of the following:
  - In the previous page, if you chose to create the PDB from a PDB archive (single TAR file) or using a PDB file set (DFB file and an XML file), then select the type of location where you want to store the target data files for the PDB you are plugging in.

- If the target CDB (*CDB to which you are plugging in the unplugged PDB*) is enabled with Oracle Managed Files and if you want to use the same, then select **Use Oracle Managed Files (OMF)**.
  - If you want to enter a common custom location, then select **Use Common Location for PDB datafiles**. Select the storage type and the location where the data files can be stored.
- In the previous page, if you chose to create the PDB using a PDB template (XML file only), then do the following:

In the PDB Datafile Locations section, validate the locations mapped for the data files. If they are incorrect, correct the paths. Alternatively, if you have a single location where the data files are all available, then enter the absolute path in the **Set Common Source File Mapping Location** field, and click **Set**.

You can choose to store the target data files for the PDB you are plugging in, in the same location as the source data files. However, if you want the target data files to be stored in a different location, then select **Copy Datafiles**, and select the type of location:

- If the target CDB (*CDB to which you are plugging in the unplugged PDB*) is enabled with Oracle Managed Files and if you want to use the same, then select **Use Oracle Managed Files (OMF)**.
- If you want to enter a common custom location, then select **Use Common Location for Pluggable Database Files**. Select the storage type and the location where the data files can be stored.
- If you prefer to use different custom locations for different data files, then select **Customized Location**, and enter the custom location paths.

13. In the Temporary Working Directory section, enter a location where the temporary files generated during the PDB creation process can be stored.
14. In the Post-Creation Scripts section, select a custom SQL script you want to run as part of this procedure, once the PDB is plugged in.

If the script is available in the Software Library, select **Select from Software Library**, then select the component that contains the custom script.

15. Click **Next**.

16. In the Schedule page, enter a unique deployment procedure instance name and a schedule for the deployment. The instance name you enter here helps you identify and track the progress of this procedure on the Procedure Activity page.

If you want to run the procedure immediately, then retain the default selection, that is, **Immediately**. Otherwise, select **Later** and provide time zone, start date, and start time details.

You can optionally set a grace period for this schedule. A grace period defines the maximum permissible delay when attempting to run a scheduled procedure. If the procedure does not start within the grace period you have set, then the procedure skips running. To set a grace period, select **Grace Period**, then set the permissible delay time.

17. Click **Next**.

18. In the Review page, review the details you have provided for the deployment procedure. If you are satisfied with the details, click **Submit**.

If you want to modify the details, then click **Back** repeatedly to reach the page where you want to make the changes.

19. In the Procedure Activity page, view the status of the procedure. From the **Procedure Actions** menu, you can select **Debug** to set the logging level to Debug, and select **Stop** to stop the procedure execution.

When you plug in an unplugged PDB, the Enterprise Manager job system creates a Create Pluggable Database job. For information about viewing the details of this job, refer "[Viewing Create PDB Job Details with Cloud Control](#)".

## 26.3.3 Cloning a PDB with Cloud Control

You can clone a PDB using either the Full Clone method, or the Snap Clone method.

This section contains the following topics:

- [Prerequisites](#)  
Prerequisites must be met when cloning a PDB.
- [Procedure](#)  
Follow these steps to clone an existing PDB.

### 26.3.3.1 Prerequisites

Prerequisites must be met when cloning a PDB.

- Oracle Software Library (Software Library) must be set up in Cloud Control.  
For information on how to set up Software Library in Cloud Control, see *Oracle Enterprise Manager Lifecycle Management Administrator's Guide*.
- The source PDB (the PDB that you want to clone) must exist, and must be a Cloud Control target.



#### Note:

For information on how to create a new PDB, refer to "[Creating a New PDB](#)".

- The source PDB must be open.
- The target CDB (the CDB into which you want to plug in the cloned PDB) must exist, and must be a Cloud Control target.
- The target CDB must be in read/write mode.
- The target host user must be the owner of the Oracle Home that the source CDB belongs to.

To clone a PDB using the Snap Clone method, you must meet the following additional prerequisites:

- The 12.1.0.5 Enterprise Manager for Oracle Database plug-in must be downloaded and deployed. Also, the 12.1.0.3 SMF plug-in or higher must be downloaded and deployed.
- The PDB that you want to clone must reside on a registered storage server. This storage server must be synchronized.

For information on how to register a storage server and synchronize storage servers, see *Oracle Enterprise Manager Cloud Administration Guide*.

- All the datafiles of the PDB that you want to clone must reside on the storage volumes of the storage server, and not on the local disk.
- Metric collections must be run on the source CDB (the CDB containing the PDB that you want to clone), the source CDB host, and the PDB that you want to clone.
- The Snap Clone feature must be enabled for the PDB that you want to clone.

For information on how to enable the Snap Clone feature, see *Oracle Enterprise Manager Cloud Administration Guide*.

### 26.3.3.2 Procedure

Follow these steps to clone an existing PDB.

 **Note:**

If you use the Full Clone method to clone a PDB, you can clone the PDB only to the source CDB (the CDB containing the PDB that you are cloning).

1. From the **Enterprise** menu, select **Provisioning and Patching**, then select **Database Provisioning**. In the Database Provisioning page, in the Related Links section of the left menu pane, click **Provision Pluggable Databases**.

 **Note:**

You can also access the Provision Pluggable Database Console from the Home page of the CDB. To do so, in the CDB's Home page, from the **Oracle Database** menu, select **Provisioning**, then select **Provision Pluggable Database**.

2. In the Provision Pluggable Database Console, in the CDB section, select the source CDB, that is, the CDB containing the PDB that you want to clone.

 **Note:**

Skip this step if you have accessed the Provision Pluggable Database Console from the CDB's Home page.

3. In the PDB Operations section, select **Create New Pluggable Databases**.
4. Click **Launch**.

 **Note:**

You will be prompted to log in to the database if you have not already logged in to it through Enterprise Manager. Make sure you log in using SYSDBA user account credentials.

5. In the Creation Options page of the Create Pluggable Database Wizard, in the PDB Creation Options section, select **Clone an Existing PDB**.

To clone a PDB using the traditional method of cloning the PDB data files, select **Full Clone**. Use this method if you want to clone a PDB for long term usage. This method is ideal for load testing, when you plan to make significant data updates to the PDB clone. However, this method takes longer, and a clone that is created using this method occupies considerable space, as compared to the Snap Clone method.

To clone a PDB using the Storage Management Framework (SMF) Snap Clone feature, select **Snap Clone**. Use this method if you want to clone a PDB for short term purposes. This method is ideal for functional testing, as the cloning process is quick, and a PDB clone that is created using this method occupies very little space. However, this method is not suitable if you plan to make significant data updates to the PDB clone.

For **Source PDB**, select the PDB that you want to clone.

6. In the CDB Host Credentials section, select or specify the source CDB Oracle Home owner host credentials. If you have already registered the credentials with Enterprise Manager, you can select **Preferred** or **Named**. Otherwise, you can select **New** and enter the credentials.
7. Click **Next**.
8. In the Identification page, enter a unique name for the PDB you are cloning.

If you prefer to create more than one PDB in this procedure, then select **Create Multiple Copies**, and set the number of PDBs you want to create. Note that you can create a maximum of 252 PDBs.

 **Note:**

If you choose to create multiple PDBs, then the unique name you enter here is used as a prefix for all the cloned PDBs, and the suffix is a numeric value that indicates the count of PDBs.

For example, if you create five PDBs with the name `accountsPDB`, then the PDBs are created with the names `accountsPDB1`, `accountsPDB2`, `accountsPDB3`, `accountsPDB4`, and `accountsPDB5`.

9. In the PDB Administrator section, do one of the following to administer the PDB:
  - If you prefer to use the admin user account that was created as part of the source PDB that you are cloning, then deselect **Create PDB Administrator**.
  - If you want to create a new admin user account for the PDB you are cloning, then select **Create PDB Administrator**, and enter the desired credentials.

 **Note:**

If you choose to create multiple PDBs, then an admin user account is created for each PDB that you create, with the same set of the specified credentials.

10. In the Source CDB Login Credentials section, select or specify the login credentials of the source CDB. If you have already registered the credentials with Enterprise Manager, you can select **Preferred** or **Named**. Otherwise, you can select **New** and enter the credentials.

The credentials are used to bring the source PDB to read-only mode before the cloning operation begins, and to restore it to the original state after the cloning operation ends.

If you chose the Snap Clone method (on the Source page of the Create Pluggable Database Wizard) to clone the PDB, specify the host credentials for the source CDB.

 **Note:**

If you are cloning the source PDB to the source CDB itself, then the Source CDB Login Credentials section is not displayed, that is, you do not need to provide the source CDB login credentials or the source CDB host credentials.

If you are cloning the source PDB to a CDB different from the source CDB, and this CDB resides on the source CDB host, then you must provide the source CDB login credentials. You do not need to provide the source CDB host credentials.

If you are cloning the source PDB to a CDB different from the source CDB, and this CDB resides on a host different from the source CDB host, then you must provide the source CDB login credentials and the source CDB host credentials.

11. Click **Next**.
12. In the Storage page, specify the storage information.

If you chose the Full Clone method to clone the PDB, select the type of location where you want to store the PDB datafiles in the following manner:

- If the source CDB is enabled with Oracle Managed Files and if you want to use the same, then select **Use Oracle Managed Files (OMF)**.
- If you want to enter a custom location, then select **Use Common Location for PDB datafiles**. Select the storage type and the location where the datafiles can be stored.

If you chose the Snap Clone method to clone the PDB, do the following:

- In the PDB Datafile Locations section, specify a value for **Mount Point Prefix**, that is, the mount location for the storage volumes. You can choose to specify the same prefix for all the volumes, or a different prefix for each volume. Also, specify a value for **Writable Space**, that is, the space that you want to allocate for writing the changes made to the PDB clone. You can choose to specify the same writable space value for all the volumes, or a different value for each volume.
- In the Privileged Host Credentials section, select or specify the credentials of the root user. These credentials are used for mounting the cloned volumes on the destination host.



If you have already registered the credentials with Enterprise Manager, you can select **Preferred** or **Named**. Otherwise, you can select **New** and enter the credentials.

13. In the Temporary Working Directory section, enter a location where the temporary files generated during the PDB creation process can be stored.
14. In the Post-Creation Scripts section, select a custom SQL script you want to run as part of this procedure, once the PDB is cloned.
15. Click **Next**.
16. In the Schedule page, enter a unique deployment procedure instance name and a schedule for the deployment. The instance name you enter here helps you identify and track the progress of this procedure on the Procedure Activity page.

If you want to run the procedure immediately, then retain the default selection, that is, **Immediately**. Otherwise, select **Later** and provide time zone, start date, and start time details.

You can optionally set a grace period for this schedule. A grace period defines the maximum permissible delay when attempting to run a scheduled procedure. If the procedure does not start within the grace period you have set, then the procedure skips running. To set a grace period, select **Grace Period**, and set the permissible delay time.

17. Click **Next**.
18. In the Review page, review the details you have provided for the deployment procedure. If you are satisfied with the details, click **Submit**.

If you want to modify the details, then click **Back** repeatedly to reach the page where you want to make the changes.

19. In the Procedure Activity page, view the status of the procedure. From the **Procedure Actions** menu, you can select **Debug** to set the logging level to Debug, and select **Stop** to stop the procedure execution.

When you clone a PDB, the Enterprise Manager job system creates a Create Pluggable Database job. For information about viewing the details of this job, refer "[Viewing Create PDB Job Details with Cloud Control](#)".

## 26.3.4 Migrating a Non-CDB to a PDB with Cloud Control

You can migrate a non-CDB to a PDB.

This section contains the following topics:

- [Prerequisites](#)  
Prerequisites must be met when migrating a non-CDB to a PDB.
- [Procedure](#)  
Follow these steps to migrate a non-CDB to a PDB.

### 26.3.4.1 Prerequisites

Prerequisites must be met when migrating a non-CDB to a PDB.

- Oracle Software Library (Software Library) must be set up in Cloud Control.  
For information on how to set up Software Library in Cloud Control, see *Oracle Enterprise Manager Lifecycle Management Administrator's Guide*.

- The target CDB (the CDB to which you want to migrate a non-CDB to a PDB) must exist, and must be a Cloud Control target.
- The target CDB must be in read/write mode.
- The non-CDB that you want to migrate and the target CDB must be running in ARCHIVELOG mode.
- The database administrators of the database you want to migrate and the target CDB must have SYSDBA privileges.
- The target host user must be the owner of the Oracle Home that the target CDB belongs to.

## 26.3.4.2 Procedure

Follow these steps to migrate a non-CDB to a PDB.

1. From the **Enterprise** menu, select **Provisioning and Patching**, then select **Database Provisioning**. In the Database Provisioning page, in the Related Links section of the left menu pane, click **Provision Pluggable Databases**.

 **Note:**

You can also access the Provision Pluggable Database Console from the Home page of the CDB. To do so, in the CDB's Home page, from the **Oracle Database** menu, select **Provisioning**, then select **Provision Pluggable Database**.

2. In the Provision Pluggable Database Console, in the Container Database section, select the CDB to which you want to migrate a non-CDB to a PDB.

 **Note:**

Skip this step if you have accessed the Provision Pluggable Database Console from the CDB's Home page.

3. In the PDB Operations section of the Provision Pluggable Database page, select the **Migrate Existing Databases** option and click **Launch**.
4. On the Database Login page, select the Credential Name from the drop-down list. Click **Login**.
5. On the Migrate Non-CDBs launch page, select a data migration method, that is, **Export/Import** or **Plug as a PDB**. If you select **Plug as a PDB**, ensure that the non-CDB that you want to migrate is open, and is in read-only mode.  
Enter the appropriate credentials for the Oracle Home Credential section.  
Click **Next**.
6. On the Database page, select a Non-CDB to be migrated. You can select more than one. Click **Add**. In the database pane, provide the appropriate credential, properties, export, import, and datafile location information. Click **Next**.

7. On the Schedule page, enter the appropriate job and scheduling details. Click **Next**.
8. On the Review page, review all details entered. If there are no changes required, click **Submit**.

## 26.4 Removing PDBs with Cloud Control

You can unplug and delete PDBs.

This section contains the following topics:

- [Unplugging and Dropping a PDB with Cloud Control](#)  
You can unplug or drop a PDB.
- [Deleting PDBs with Cloud Control](#)  
You can delete a PDB from a CDB.

### 26.4.1 Unplugging and Dropping a PDB with Cloud Control

You can unplug or drop a PDB.

#### **Note:**

As an alternative to using the method described in this section, you can use Enterprise Manager Command Line Interface (EM CLI) to unplug and drop PDBs. For more information, see *Oracle® Enterprise Manager Lifecycle Management Administrator's Guide*.

This section contains the following topics:

- [Prerequisites](#)  
Prerequisites must be met when unplugging and dropping a PDB.
- [Procedure](#)  
Follow these steps to create unplug a PDB from its CDB.

#### 26.4.1.1 Prerequisites

Prerequisites must be met when unplugging and dropping a PDB.

- Oracle Software Library (Software Library) must be set up in Cloud Control.  
For information on how to set up Software Library in Cloud Control, see *Oracle Enterprise Manager Lifecycle Management Administrator's Guide*.
- The PDB that you want to unplug and drop must have been opened at least once.
- The target host user must be the owner of the Oracle Home that the CDB (containing the PDB that you want to unplug and drop) belongs to.

#### 26.4.1.2 Procedure

Follow these steps to create unplug a PDB from its CDB.

1. From the **Enterprise** menu, select **Provisioning and Patching**, then select **Database Provisioning**. In the Database Provisioning page, in the Related Links section of the left menu pane, click **Provision Pluggable Databases**.

 **Note:**

You can also access the Provision Pluggable Database Console from the Home page of the CDB. To do so, in the CDB's Home page, from the **Oracle Database** menu, select **Provisioning**, then select **Provision Pluggable Database**.

2. In the Provision Pluggable Database Console, in the Container Database section, select the CDB from which you want to unplug the PDBs.

 **Note:**

Skip this step if you have accessed the Provision Pluggable Database Console from the CDB's Home page.

3. In the PDB Operations section, select **Unplug Pluggable Database**.
4. Click **Launch**.

 **Note:**

You will be prompted to log in to the database if you have not already logged in to it through Enterprise Manager. Make sure you log in using `SYSDBA` user account credentials.

5. In the Select PDB page of the Unplug Pluggable Database Wizard, in the Select Pluggable Database section, select the PDB you want to unplug. Note that the PDB once unplugged will be stopped and dropped.
6. In the Container Database Host Credentials section, select or specify the target CDB Oracle Home owner host credentials. If you have already registered the credentials with Enterprise Manager, you can select **Preferred** or **Named**. Otherwise, you can select **New** and enter the credentials.
7. In the Destination page, select the type of PDB template you want to generate for unplugging the PDB, and the location where you want to store it. The PDB template consists of all data files as well as the metadata XML file.
  - If you want to store the PDB template on your CDB host (*CDB from which you are unplugging the PDB*), then select **Target Host File System**.
    - If you want to generate a single archive file—a TAR file with the data files and the metadata XML file included in it, then select **Generate PDB Archive**. Select a location where the archive file can be created.

 **Note:**

Oracle recommends that you select this option if the source and target CDBs are using file system for storage. This option is not supported for PDBs using ASM as storage.

- If you want to generate an archive file set—a separate DFB file with all the data files and a separate metadata XML file, then select **Generate PDB File Set**. Select the locations where the DBF and XML files can be created.

 **Note:**

Oracle recommends that you select this option if the source and target CDBs are using ASM for storage.

- If you want to generate only a metadata XML file, leaving the data files in their current location, then select **Generate PDB Metadata File**. Select a location where the metadata XML file can be created.
- If you want to store the PDB template in Oracle Software Library (Software Library), then select **Software Library**.
  - If you want to generate a single archive file—a TAR file with the data files and the metadata XML file included in it, then select **Generate PDB Archive**. If you want to generate an archive file set—a separate DFB file with all the data files and a separate metadata XML file, then select **Generate PDB File Set**. If you want to generate only a metadata XML file, leaving the data files in their current location, then select **Generate PDB Metadata File**.
  - Enter a unique PDB template name.

The template is created in the default location that has the following format:

```
Database Configuration/db_release/platform/Database Templates
```

For example,

```
Database Configuration/12.1.0.0.2/unix/Database Templates
```

- Enter a temporary location where the archive can be created by Enterprise Manager before it is uploaded to the Software Library.
8. In the Schedule page, enter a unique deployment procedure instance name and a schedule for the deployment. The instance name you enter here helps you identify and track the progress of this procedure on the Procedure Activity page.

If you want to run the procedure immediately, then retain the default selection, that is, **Immediately**. Otherwise, select **Later** and provide time zone, start date, and start time details.

You can optionally set a grace period for this schedule. A grace period defines the maximum permissible delay when attempting to run a scheduled procedure. If the procedure does not start within the grace period you have set, then the procedure

skips running. To set a grace period, select **Grace Period**, and set the permissible delay time.

9. Click **Next**.
10. In the Review page, review the details you have provided for the deployment procedure. If you are satisfied with the details, click **Submit**.  
If you want to modify the details, then click **Back** repeatedly to reach the page where you want to make the changes.
11. In the Procedure Activity page, view the status of the procedure. From the **Procedure Actions** menu, you can select **Debug** to set the logging level to Debug, and select **Stop** to stop the procedure execution.

When you unplug and drop a PDB, the Enterprise Manager job system creates an Unplug Pluggable Database job. For information about viewing the details of this job, refer "[Viewing Unplug PDB Job Details](#)".

## 26.4.2 Deleting PDBs with Cloud Control

You can delete a PDB from a CDB.

This section contains the following topics:

- [Prerequisites](#)  
Prerequisites must be met when permanently deleting a set of PDBs from a CDB.
- [Procedure](#)  
Follow these steps to permanently delete a set of PDBs from a CDB.

### 26.4.2.1 Prerequisites

Prerequisites must be met when permanently deleting a set of PDBs from a CDB.

- The 12.1.0.5 Enterprise Manager for Oracle Database plug-in must be downloaded and deployed.  
For information on how to download and deploy a plug-in, see *Oracle Enterprise Manager Cloud Control Administrator's Guide*.
- Oracle Software Library (Software Library) must be set up in Cloud Control.  
For information on how to set up Software Library in Cloud Control, see *Oracle Enterprise Manager Lifecycle Management Administrator's Guide*.
- The PDBs that you want to delete must have been opened at least once.
- The target host user must be the owner of the Oracle home that the CDB (containing the PDBs that you want to delete) belongs to.

### 26.4.2.2 Procedure

Follow these steps to permanently delete a set of PDBs from a CDB.

1. From the **Enterprise** menu, select **Provisioning and Patching**, then select **Database Provisioning**. In the Database Provisioning page, in the Related Links section of the left menu pane, click **Provision Pluggable Databases**.

 **Note:**

You can also access the Provision Pluggable Database Console from the Home page of the CDB. To do so, in the CDB's Home page, from the **Oracle Database** menu, select **Provisioning**, then select **Provision Pluggable Database**.

2. In the Provision Pluggable Database Console, in the CDB section, select the CDB from which you want to delete the PDBs.

 **Note:**

Skip this step if you have accessed the Provision Pluggable Database Console from the CDB's home page.

3. In the PDB Operations section, select **Delete Pluggable Databases**.
4. Click **Launch**.

 **Note:**

You will be prompted to log in to the database if you have not already logged in to it through Enterprise Manager. Make sure you log in using SYSDBA user account credentials.

5. In the Select PDBs page of the Delete Pluggable Databases Wizard, click **Add**. Select the PDBs that you want to delete, then click **Select**.

 **Note:**

If you choose to delete a PDB that was created using the Snap Clone method, the PDB mount points on the CDB host are cleaned up. The corresponding storage volumes on the storage server are also deleted. This action is irreversible.

6. In the CDB Host Credentials section, select or specify the target CDB Oracle Home owner host credentials. If you have already registered the credentials with Enterprise Manager, you can select **Preferred** or **Named**. Otherwise, you can select **New** and enter the credentials.

If one (or more) of the PDBs that you selected for deletion is the Snap Clone of another PDB, you must also provide the privileged host credentials, that is, the credentials of the root user. If you have already registered the credentials with Enterprise Manager, you can select **Preferred** or **Named**. Otherwise, you can select **New** and enter the credentials.

7. In the Schedule page, enter a unique deployment procedure instance name and a schedule for the deployment. The instance name you enter here helps you identify and track the progress of this procedure on the Procedure Activity page.

If you want to run the procedure immediately, then retain the default selection, that is, **Immediately**. Otherwise, select **Later** and provide time zone, start date, and start time details.

You can optionally set a grace period for this schedule. A grace period is a period of time that defines the maximum permissible delay when attempting to run a scheduled procedure. If the procedure does not start within the grace period you have set, then the procedure skips running. To set a grace period, select **Grace Period**, and set the permissible delay time.

8. Click **Next**.
9. In the Review page, review the details you have provided for the deployment procedure. If you are satisfied with the details, click **Submit**.  
  
If you want to modify the details, then click **Back** repeatedly to reach the page where you want to make the changes.
10. In the Procedure Activity page, view the status of the procedure. From the **Procedure Actions** menu, you can select **Debug** to set the logging level to Debug, and select **Stop** to stop the procedure execution.

When you delete a PDB, the Enterprise Manager job system creates a Delete Pluggable Database job. For information about viewing the details of this job, refer "[Viewing Delete PDB Job Details](#)".

## 26.5 Viewing PDB Job Details with Cloud Control

You can view the details of the jobs that are created by the Enterprise Manager job system when you create a PDB, unplug a PDB, or delete a PDB.

This section contains the following topics:

- [Viewing Create PDB Job Details with Cloud Control](#)  
Follow these steps to view the details of a create PDB job.
- [Viewing Unplug PDB Job Details with Cloud Control](#)  
Follow these steps to view the details of an unplug PDB job.
- [Viewing Delete PDB Job Details with Cloud Control](#)  
Follow these steps to view the details of a delete PDB job.

### 26.5.1 Viewing Create PDB Job Details with Cloud Control

Follow these steps to view the details of a create PDB job.

1. From the **Enterprise** menu, select **Provisioning and Patching**, then select **Procedure Activity**.
2. Click the deployment procedure that contains the required create PDB job.
3. Expand the deployment procedure steps. Select the PDB creation job.
4. Click **Job Summary**.
5. To view a summary of the job details, click **Summary**.

In the Prepare Configuration Data step, the system prepares for PDB creation.

In the Check Prerequisites step, the system checks the prerequisites for PDB creation.



In the Verify and Prepare step, the system runs tasks prior to PDB creation.

In the Perform Configuration step, the PDB creation is performed. For details of the performed tasks and their status, refer to the remote log files present on the host.

In the Post Configuration step, Enterprise Manager is updated with the newly created PDB details, and the custom scripts are run.

6. To view a visual representation of the create PDB job progress, click **Results**.

In the Configuration Progress section, you can view the completion percentage of the job, and a list of pending, currently running, and completed job steps. You can also view errors, warnings, and logs. The tail of the log for the currently running job step is displayed.

## 26.5.2 Viewing Unplug PDB Job Details with Cloud Control

Follow these steps to view the details of an unplug PDB job.

1. From the **Enterprise** menu, select **Provisioning and Patching**, then select **Procedure Activity**.
2. Click the deployment procedure that contains the required unplug PDB job.
3. Expand the deployment procedure steps. Select the unplug PDB job.
4. Click **Job Summary**.
5. To view a summary of the job details, click **Summary**.

In the Prepare Configuration Data step, the system prepares for unplugging a PDB.

In the Check Prerequisites step, the system checks the prerequisites for unplugging a PDB.

In the Verify and Prepare step, the system runs tasks prior to unplugging the PDB.

In the Perform Configuration step, the PDB unplugging is performed. For details of the performed tasks and their status, refer to the remote log files present on the host.

In the Post Configuration step, Enterprise Manager is updated with the unplugged PDB details.

6. To view a visual representation of the unplug PDB job progress, click **Results**.

In the Configuration Progress section, you can view the completion percentage of the job, and a list of pending, currently running, and completed job steps. You can also view errors, warnings, and logs. The tail of the log for the currently running job step is displayed.

## 26.5.3 Viewing Delete PDB Job Details with Cloud Control

Follow these steps to view the details of a delete PDB job.

1. From the **Enterprise** menu, select **Provisioning and Patching**, then select **Procedure Activity**.
2. Click the deployment procedure that contains the required delete PDB job.
3. Expand the deployment procedure steps. Select the delete PDB job.

4. Click **Job Summary**.

5. To view a summary of the job details, click **Summary**.

In the Prepare Configuration Data step, the system prepares for deleting the PDBs.

In the Verify and Prepare step, the system runs tasks prior to deleting the PDBs.

In the Perform Configuration step, the PDB deletion is performed. For details of the performed tasks and their status, refer to the remote log files present on the host.

In the Post Configuration step, Enterprise Manager is updated with the deleted PDB details.

6. To view a visual representation of the delete PDB job progress, click **Results**.

In the Configuration Progress section, you can view the completion percentage of the job, and a list of pending, currently running, and completed job steps. You can also view errors, warnings, and logs. The tail of the log for the currently running job step is displayed.

# Administering CDBs and PDBs with Cloud Control

You can administer CDBs and PDBs with Oracle Enterprise Manager Cloud Control.

This section contains the following topics:

- [Administering CDB Storage and Schema Objects with Cloud Control](#)  
You can administer CDB storage and schema objects with Oracle Enterprise Manager Cloud Control.
- [Administering PDBs with Cloud Control](#)  
You can use Oracle Enterprise Manager Cloud Control to switch between PDBs and alter the open mode of a PDB.



## See Also:

["About CDB Administration"](#)

## 27.1 Administering CDB Storage and Schema Objects with Cloud Control

You can administer CDB storage and schema objects with Oracle Enterprise Manager Cloud Control.

This section contains the following topics:

- [About Managing and Monitoring CDB Storage and Schema Objects](#)  
You can use Enterprise Manager to manage and monitor CDB storage and schema objects.
- [Managing CDB Storage and Schema Objects](#)  
You can manage CDB storage and schema objects with Oracle Enterprise Manager Cloud Control.
- [Managing Per-Container Storage and Schema Objects](#)  
You can manage per-container storage and schema objects with Oracle Enterprise Manager Cloud Control.
- [Monitoring Storage and Schema Alerts](#)  
You can monitor storage and schema alerts with Oracle Enterprise Manager Cloud Control.

## 27.1.1 About Managing and Monitoring CDB Storage and Schema Objects

You can use Enterprise Manager to manage and monitor CDB storage and schema objects.

With Enterprise Manager you can:

- View database storage objects, such as tablespaces, and schema objects, such as tables, across the CDB. You can also view objects belonging to the `CDB$ROOT` container.
- View and manage database storage and schema objects at the container level.
- Use storage metrics to gather data across the CDB and generate Enterprise Manager incidents (alerts) at the container level.
- Run Storage and Undo Advisors for the CDB and view related storage advice.
- Support configuration metric collection for CDB/PDB.

The Database Object Search pages are displayed when you select certain menu items from either the Schema or Administration menus. These pages conduct searches for database objects based on criteria you enter, such as schema name, object name, or container name, which is only available if you are viewing from the CDB level. The Database Object Search page features are supported at both the CDB level and PDB level. The Container column displays on the Search page at both the CDB level and container level.

Undo tablespaces can only be managed from the `CDB$ROOT` container.

## 27.1.2 Managing CDB Storage and Schema Objects

You can manage CDB storage and schema objects with Oracle Enterprise Manager Cloud Control.

To manage CDB storage and schema objects, follow these steps:

1. Navigate to the CDB database home page.
2. From the CDB menu, access a feature supporting the CDB level view, such as accessing the Tablespaces Search page.
3. Log in as a common user. The Tablespaces Search page displays in the CDB context.
4. Perform a search. In the above example, the Tablespace page displays all tablespaces within the CDB including those belonging to the `CDB$ROOT` container. An additional column displays the container name.
5. Perform any management feature if you have the proper privilege associated with that operation.

## 27.1.3 Managing Per-Container Storage and Schema Objects

You can manage per-container storage and schema objects with Oracle Enterprise Manager Cloud Control.

To manage per-container storage and schema objects, follow these steps:

1. Navigate to a CDB target.
2. From the Administration menu, select Storage, then, select Tablespaces.
3. Log in as a common user. The Tablespaces Search page is displayed using CDB as its context.
4. Switch to a specific container. Once context switcher is used to switch containers, the pages automatically refresh and show container-only data.
5. Perform a search. The Tablespace page displays all tablespaces within the selected container.
6. You can perform any management feature for which you have the proper privilege associated with that operation.

## 27.1.4 Monitoring Storage and Schema Alerts

You can monitor storage and schema alerts with Oracle Enterprise Manager Cloud Control.

To monitor storage and schema alerts, follow these steps:

1. Navigate to a Pluggable Database target.
2. From the Oracle Database menu, select **Monitoring**, then select **Incident Manager**.

Open incidents for Storage and Schema area metrics are displayed. The container name is part of the incident message.

## 27.2 Administering PDBs with Cloud Control

You can use Oracle Enterprise Manager Cloud Control to switch between PDBs and alter the open mode of a PDB.

This section contains the following topics:

- [Switching Between PDBs](#)  
If you are performing a task such as granting user privileges or performance reporting, and you need to perform the same task on another PDB, then you can use Oracle Enterprise Manager Cloud Control to switch to another PDB.
- [Altering the Open Mode of a PDB](#)  
You can change the open mode of a PDB with Oracle Enterprise Manager Cloud Control.

## 27.2.1 Switching Between PDBs

If you are performing a task such as granting user privileges or performance reporting, and you need to perform the same task on another PDB, then you can use Oracle Enterprise Manager Cloud Control to switch to another PDB.

To switch between PDBs while staying on the same feature page:

1. From the current PDB, select any PDB scope page (such as, Manage Advanced Queues).  
In the upper-left corner of the window, the name of the PDB will update to display a context switcher as a drop-down menu.
2. Click the context switcher to display the drop-down menu. This menu shows the PDBs most recently used.  
Select a PDB from this list.
3. The page will update to show the System Queues.
4. Click the context switcher to display the drop-down menu. If the menu does not show the PDBs you want, then select **All Containers**.
5. A Switch Container window will pop up to display all available PDBs for the monitored target.  
Select a PDB from this list and click **OK**.
6. The page will update to show data for the selected PDB.

## 27.2.2 Altering the Open Mode of a PDB

You can change the open mode of a PDB with Oracle Enterprise Manager Cloud Control.

To change the open mode of a single-instance PDB to Open or Close:

1. From the **Oracle Database** menu, select **Control**, then select **Open/Close Pluggable Database**.
2. From the Open/Close Pluggable Database page, select a PDB from the list.
3. Click on **Open**, **Open Read Only**, or **Close**.
4. In the Confirmation dialog window, click **Yes** to complete the change. A Processing dialog window appears to show you the progress of your choice.
5. Once the open mode change completes, the Open/Close PDB page will update to show the new open mode of the PDB.

To change the open mode of a PDB in a Cluster/RAC to Open or Close:

1. From the **Oracle Database** menu, select **Control**, then **Open/Close Pluggable Database**.
2. From the Open/Close Pluggable Database page, select a PDB from the list. The RAC instances are shown along with the PDB's current open mode on those instances.
3. Once you select a PDB, a panel appears below the list to show the open mode of the PDBs on the different RAC instances. The open and close options apply to the

PDBs on the RAC instance's panel. You can open or close a PDB on any number of available RAC instances.

4. In the Confirmation dialog window, click **Yes** to complete the change. A Processing dialog window appears to show you the progress of your choice.
5. Once the open mode change completes, the Open/Close Pluggable Database page will update to show the new open mode of the PDB.

# 28

## Using Oracle Resource Manager for PDBs with Cloud Control

You can use Oracle Resource Manager for a multitenant environment with Oracle Enterprise Manager Cloud Control.

This chapter contains the following topics:

- [About CDB Resource Manager and Cloud Control](#)  
You can use Enterprise Manager to manage multitenant container database (CDB) resource plans. Resource Manager provides CDB and pluggable database (PDB) resource management. At the CDB level, Enterprise Manager provides new resource plan creation and resource plan monitoring functionality.
- [Creating a CDB Resource Plan with Cloud Control](#)  
You can create a CDB resource plan with Oracle Enterprise Manager Cloud Control that allocates shares of system resources to all PDBs within a CDB.
- [Creating a PDB Resource Plan with Cloud Control](#)  
You can create a PDB resource plan with Oracle Enterprise Manager Cloud Control.

### See Also:

- ["Initialization Parameters for Multitenant Resource Management"](#)
- ["Overview of Oracle Resource Manager in a Multitenant Environment"](#)

### 28.1 About CDB Resource Manager and Cloud Control

You can use Enterprise Manager to manage multitenant container database (CDB) resource plans. Resource Manager provides CDB and pluggable database (PDB) resource management. At the CDB level, Enterprise Manager provides new resource plan creation and resource plan monitoring functionality.

The CDB Resource Plans page lists all CDB plans available in the system. Each row displays information about the specific CDB plan while the PDB Resource Plans page displays the PDB plans, one row for each PDB plan. Each plan is selectable and you can click on the plan name to drill down for more detailed information. You can edit or view a selected plan or you can create a new plan.



## 28.2 Creating a CDB Resource Plan with Cloud Control

You can create a CDB resource plan with Oracle Enterprise Manager Cloud Control that allocates shares of system resources to all PDBs within a CDB.

To create a CDB resource plan, follow these steps:

1. From the **Administration** menu, choose **Resource Manager**.  
Enterprise Manager displays the Resource Manager home page.
2. On the Resource Manager home page, click the **Resource Plan** link.  
If the current target is a CDB, then a CDB top level Resource Plans page displays. The page lists CDB plans that are available in the system, one row per CDB plan. Each row displays information about the CDB plan, such as Plan Name and whether it is active. You can drill-down for more information about each plan.
3. Click **Create** to create a new resource plan.  
Enterprise Manager displays the CDB Resource Plan detail page. The page contains CDB Resource plan settings on the top, such as the Plan Name. You can add or remove PDBs to this plan by clicking the **Add/Remove** button. A select PDB page appears that allows you to choose PDBs. When you add a PDB, each PDB displays the Share Allocation and Utilization Limit.
4. Fill in the required information and click **Apply**.  
A new resource plan is created and all fields are updated.

## 28.3 Creating a PDB Resource Plan with Cloud Control

You can create a PDB resource plan with Oracle Enterprise Manager Cloud Control.

To create a PDB resource plan, follow these steps:

1. From the **Administration** menu, choose **Resource Manager**.  
Enterprise Manager displays the Resource Manager home page.
2. Click on the Plans link under the Pluggable Database section.  
If you are currently connected to a PDB or Single Instance database target, you see the PDB Resource Plan page. This page displays a list of resource plans that are available in the database. Each row displays information about the plan, such as plan name and whether the plan is active. You can drill down for more information about each plan.  
The Advanced radio button is only shown when an existing advanced plan is displayed. When creating or editing a new plan, Advanced mode is not supported.
3. Click **Create** to create a new resource plan.  
Enterprise Manager displays the PDB Resource Plan detail page. The page contains PDB Resource plan settings. The page lists consumer groups that do not have default settings. Click the **Add/Remove** button to add or remove consumer groups and set the value.
4. Enter the required information in all fields and click **Apply**.

# Managing Security for a Multitenant Environment in Enterprise Manager

You can manage common and local users and roles for a multitenant environment by using Oracle Enterprise Manager.

This section contains the following topics:

- [About Managing Security for a Multitenant Environment in Enterprise Manager](#)  
Oracle Enterprise Manager Cloud Control supports the management of multitenant environment security.
- [Managing Common and Local Users in Enterprise Manager](#)  
In a multitenant environment, Oracle Enterprise Manager enables you to create, edit, and drop common and local users.
- [Managing Common and Local Roles and Privileges in Enterprise Manager](#)  
In a multitenant environment, you can use Oracle Enterprise Manager to create, edit, drop, and revoke common and local roles.

## 29.1 About Managing Security for a Multitenant Environment in Enterprise Manager

Oracle Enterprise Manager Cloud Control supports the management of multitenant environment security.

In a multitenant environment, you can use Oracle Enterprise Manager Cloud Control to create, manage, and monitor common users and roles for both the root and the associated pluggable databases (PDBs).

Enterprise Manager enables you to switch easily between the root and a designated PDB.

### Related Topics

- [Oracle Database Security Guide](#)

## 29.2 Managing Common and Local Users in Enterprise Manager

In a multitenant environment, Oracle Enterprise Manager enables you to create, edit, and drop common and local users.

This section contains the following topics:

- [Creating a Common User Account in Enterprise Manager](#)  
A common user is a user that exists in the root and can access PDBs in the CDB.

- [Editing a Common User Account in Enterprise Manager](#)  
You can edit a common user account from the root.
- [Dropping a Common User Account in Enterprise Manager](#)  
You can drop a common user from the CDB root.
- [Creating a Local User Account in Enterprise Manager](#)  
A local user is a user that exists only in a specific PDB and does not have access to any other PDBs in the multitenant environment.
- [Editing a Local User Account in Enterprise Manager](#)  
You can edit a local user from the PDB in which the local user resides.
- [Dropping a Local User Account in Enterprise Manager](#)  
You can drop a local user from the PDB in which the local user resides.

## 29.2.1 Creating a Common User Account in Enterprise Manager

A common user is a user that exists in the root and can access PDBs in the CDB.

1. From the Enterprise Manager database home page, log in to the root as a common user who has the common `CREATE USER` and `SET CONTAINER` privileges.
2. From the **Administration** menu, select **Security**, then **Users**.  
If prompted, enter your login information. Afterward, the Users page appears.
3. Click **Create**.

The Create User page appears.

The screenshot shows the 'Create User' page in Oracle Enterprise Manager. The page is titled 'Users > Create User' and shows the 'General' tab selected. The form includes the following fields and options:

- Name:** A text input field with a note: 'Common user name must begin with "C##".'
- Profile:** A dropdown menu set to 'DEFAULT'.
- Authentication:** A dropdown menu set to 'Password'.
- Enter Password:** A text input field.
- Confirm Password:** A text input field.
- Expire Password now:** A checkbox that is currently unchecked.
- Default Tablespace:** A text input field with a magnifying glass icon.
- Temporary Tablespace:** A text input field with a magnifying glass icon.
- Status:** Radio buttons for 'Locked' and 'Unlocked', with 'Unlocked' selected.

A note at the bottom of the page states: 'Note: Created user will be a common user since you are in CDB\$ROOT container.'

4. Select the options to create a common user and grant this user privileges.  
Ensure that you preface the user name with `C##` or `c##`.
5. Click **OK** or **Apply**.  
The common user is created in the root and will appear in the Users page for any associated PDBs.

### Related Topics

- [Logging into a Multitenant Environment in Enterprise Manager](#)  
In a multitenant environment, you can log in to a CDB or a PDB, and switch from a PDB to a different PDB or to the root.

## 29.2.2 Editing a Common User Account in Enterprise Manager

You can edit a common user account from the root.

1. From the Enterprise Manager database home page, log in to the root as a common user who has the common `CREATE USER` and `SET CONTAINER` privileges.
  - If you are logging into the root, then ensure that you are a common user who has the common `CREATE USER` and `SET CONTAINER` privileges.
  - If you are logging into a PDB, ensure that you have the `CREATE USER` privilege for that PDB.

2. From the **Administration** menu, select **Security**, then **Users**.

If prompted, enter your login information. Afterward, the Users page appears. In the root, only common users are listed. In the PDB, both common and local users are listed.

3. Select the common user to be edited and then click **Edit**.

The Edit User page appears. For a common user in the root, you can modify all settings for the common user. For a common user in a PDB, you cannot change the user password, default tablespace, and temporary tablespace. The settings that you make apply only to the current PDB. The following screen shows how a common user Edit User page appears in a PDB.

4. Modify the common user as necessary.
5. Click **Apply**.

### Related Topics

- [Logging into a Multitenant Environment in Enterprise Manager](#)  
In a multitenant environment, you can log in to a CDB or a PDB, and switch from a PDB to a different PDB or to the root.

## 29.2.3 Dropping a Common User Account in Enterprise Manager

You can drop a common user from the CDB root.

1. From the Enterprise Manager database home page, log in to the root as a common user who has the common `CREATE USER` and `SET CONTAINER` privileges.  
You cannot drop common users from PDBs.
2. From the **Administration** menu, select **Security**, then **Users**.  
If prompted, enter your login information. Afterward, the Users page appears, listing only common users.
3. Select the common user that you want to drop and then click **Delete**.
4. Confirm that you want to delete the common user.

#### Related Topics

- [Logging into a Multitenant Environment in Enterprise Manager](#)  
In a multitenant environment, you can log in to a CDB or a PDB, and switch from a PDB to a different PDB or to the root.

## 29.2.4 Creating a Local User Account in Enterprise Manager

A local user is a user that exists only in a specific PDB and does not have access to any other PDBs in the multitenant environment.

1. From the Enterprise Manager database home page, log in to the root as a local or common user who has the local `CREATE USER` privilege.
2. From the **Administration** menu, select **Security**, then **Users**.  
If prompted, enter your login information. Afterward, the Users page appears, showing only local users for the current PDB.
3. Click **Create**.  
The Create User page appears.
4. Select the options that create a local user and grant this user privileges.  
Ensure that you do not preface the user name with `c##` or `c###`.
5. Click **OK**.  
The local user is created in the current PDB.

#### Related Topics

- [Logging into a Multitenant Environment in Enterprise Manager](#)  
In a multitenant environment, you can log in to a CDB or a PDB, and switch from a PDB to a different PDB or to the root.
- *Oracle Database Security Guide*

## 29.2.5 Editing a Local User Account in Enterprise Manager

You can edit a local user from the PDB in which the local user resides.

1. From the Enterprise Manager database home page, log in to the PDB as a local or common user who has the local `CREATE USER` privilege.
2. From the **Administration** menu, select **Security**, then **Users**.  
If prompted, enter your login information. Afterward, the Users page appears, showing only local users for the current PDB and common users.

3. Select the local user to be edited and then click **Edit**.

The Edit User page appears.

4. Modify the local user as necessary.
5. Click **Apply**.

#### Related Topics

- [Logging into a Multitenant Environment in Enterprise Manager](#)  
In a multitenant environment, you can log in to a CDB or a PDB, and switch from a PDB to a different PDB or to the root.

## 29.2.6 Dropping a Local User Account in Enterprise Manager

You can drop a local user from the PDB in which the local user resides.

1. From the Enterprise Manager database home page, log in to the PDB as a local or common user who has the local `CREATE USER` privilege.
2. From the **Administration** menu, select **Security**, then **Users**.  
If prompted, enter your login information. Afterward, the Users page appears, showing only local users for the current PDB and common users. (You cannot drop common users from a PDB.)
3. Select the local user you want to drop and then click **Delete**.  
Enterprise Manager prompts you to confirm deletion of the user.
4. Confirm that you want to delete the local user.

#### Related Topics

- [Logging into a Multitenant Environment in Enterprise Manager](#)  
In a multitenant environment, you can log in to a CDB or a PDB, and switch from a PDB to a different PDB or to the root.

## 29.3 Managing Common and Local Roles and Privileges in Enterprise Manager

In a multitenant environment, you can use Oracle Enterprise Manager to create, edit, drop, and revoke common and local roles.

This section contains the following topics:

- [Creating a Common Role in Enterprise Manager](#)  
Common roles can be used to assign common privileges to common users.
- [Editing a Common Role in Enterprise Manager](#)  
You can edit a common role from the root.
- [Dropping a Common Role in Enterprise Manager](#)  
You can drop a common role from the root.
- [Revoking Common Privilege Grants in Enterprise Manager](#)  
You can revoke common privilege grants from the root.
- [Creating a Local Role in Enterprise Manager](#)  
A common role can be used to assign a local set of privileges to local users later.

- [Editing a Local Role in Enterprise Manager](#)  
You can edit a local role in the PDB in which the local role resides.
- [Dropping a Local Role in Enterprise Manager](#)  
You can drop local role from the PDB in which the local role resides.
- [Revoking Local Privilege Grants in Enterprise Manager](#)  
You can revoke local privileges in the PDB in which the privileges are used.

## 29.3.1 Creating a Common Role in Enterprise Manager

Common roles can be used to assign common privileges to common users.

These roles are valid across all containers of the multitenant environment.

1. From the Enterprise Manager database home page, log in to the root as a common user who has the common `CREATE ROLE` and `SET CONTAINER` privileges.

2. From the **Administration** menu, select **Security**, then **Roles**.

If prompted, enter your login information. Afterward, the Create Role page appears.

3. Click **Create**.

The Create Role page appears.

4. Select the options that create a common role and grant this role privileges.

Ensure that you preface the role name with `C##` or `c##`.

5. Click **OK**.

The common role is created in the root.

### Related Topics

- [Logging into a Multitenant Environment in Enterprise Manager](#)  
In a multitenant environment, you can log in to a CDB or a PDB, and switch from a PDB to a different PDB or to the root.
- [Rules for Creating Common Roles](#)  
When you create a common role, you must follow special rules.
- [Granting or Revoking Privileges to Access a PDB](#)  
You can grant and revoke privileges for PDB access in a multitenant environment.

## 29.3.2 Editing a Common Role in Enterprise Manager

You can edit a common role from the root.

1. From the Enterprise Manager database home page, log in to the root or the PDB. If you are logging into the root, then ensure that you are a common user who has the common `CREATE ROLE` and `SET CONTAINER` privileges. If you are logging into a PDB, ensure that you have the `CREATE ROLE` privilege for that PDB.
2. From the **Administration** menu, select **Security**, then **Roles**.  
If prompted, enter your login information. Afterward, the Roles page appears. In the root, only common roles are shown. In the PDB, both common and local roles are shown.
3. Select the common role to be edited and then click **Edit**.  
The Edit Role page appears. For a common user in the root, you can modify all settings for the common user.  
For a common role in a PDB, you can only change the role's authentication and grant this user different roles, system privileges, object privileges, and consumer group privileges. These settings apply only to the current PDB.
4. Modify the common user as necessary.
5. Click **Apply**.

#### Related Topics

- [Logging into a Multitenant Environment in Enterprise Manager](#)  
In a multitenant environment, you can log in to a CDB or a PDB, and switch from a PDB to a different PDB or to the root.

### 29.3.3 Dropping a Common Role in Enterprise Manager

You can drop a common role from the root.

1. From the Enterprise Manager database home page, log in to the root as a common user who has the common `CREATE ROLE` and `SET CONTAINER` privileges.  
You cannot drop common roles from PDBs.
2. From the **Administration** menu, select **Security**, then **Roles**.  
If prompted, enter your login information. Afterward, the Roles page appears, showing only common roles.
3. Select the common role that you want to drop and then click **Delete**.
4. Confirm that you want to delete the common role.

#### Related Topics

- [Logging into a Multitenant Environment in Enterprise Manager](#)  
In a multitenant environment, you can log in to a CDB or a PDB, and switch from a PDB to a different PDB or to the root.

### 29.3.4 Revoking Common Privilege Grants in Enterprise Manager

You can revoke common privilege grants from the root.

1. From the Enterprise Manager database home page, log in to the root as a common user who has the common `CREATE USER`, `CREATE ROLE`, and `SET CONTAINER` privileges.
2. From the **Administration** menu, select **Security**, then **Users**.



The Users page lists the common users.

3. Select the user whose privileges you want to revoke and then click **Edit**.

The Edit User page appears.

4. Select **Roles** or the appropriate **Privileges** tab.

Enterprise Manager displays a list of roles and privileges assigned to this user.

5. Select **Edit List** and then remove the roles or privileges as necessary.
6. Click the **OK** button.

#### Related Topics

- [Logging into a Multitenant Environment in Enterprise Manager](#)  
In a multitenant environment, you can log in to a CDB or a PDB, and switch from a PDB to a different PDB or to the root.
- [Granting or Revoking Privileges to Access a PDB](#)  
You can grant and revoke privileges for PDB access in a multitenant environment.

## 29.3.5 Creating a Local Role in Enterprise Manager

A common role can be used to assign a local set of privileges to local users later.

These roles will be valid across PDB containers for whom they are defined.

1. From the Enterprise Manager database home page, log in to the PDB as a user who has the local `CREATE ROLE` privilege.

2. From the **Administration** menu, select **Security**, then **Roles**.

The Roles page appears.

3. Click **Create**.

If prompted, enter your login information. Afterward, the Create Role page appears.

4. Select the options that create a local role and grant this role privileges.

Ensure that you do not preface the role name with `C##` or `c##`.

5. Click **OK**.

The local role is created in the current PDB.

#### Related Topics

- [Logging into a Multitenant Environment in Enterprise Manager](#)  
In a multitenant environment, you can log in to a CDB or a PDB, and switch from a PDB to a different PDB or to the root.
- [Granting or Revoking Privileges to Access a PDB](#)  
You can grant and revoke privileges for PDB access in a multitenant environment.

## 29.3.6 Editing a Local Role in Enterprise Manager

You can edit a local role in the PDB in which the local role resides.

1. From the Enterprise Manager database home page, log in to the PDB as a user who has the local `CREATE ROLE` privilege.

2. From the **Administration** menu, select **Security**, then **Roles**.  
If prompted, enter your login information. Afterward, the Roles page appears, showing only local roles for the current PDB and common roles.
3. Select the local role to be edited and then click **Edit**.  
The Edit User page appears.
4. Modify the local user as necessary.
5. Click **Apply**.

#### Related Topics

- [Logging into a Multitenant Environment in Enterprise Manager](#)  
In a multitenant environment, you can log in to a CDB or a PDB, and switch from a PDB to a different PDB or to the root.

## 29.3.7 Dropping a Local Role in Enterprise Manager

You can drop local role from the PDB in which the local role resides.

1. From the Enterprise Manager database home page, log in to the PDB as a user who has the local `CREATE ROLE` privilege.
2. From the **Administration** menu, select **Security**, then **Role**.  
If prompted, enter your login information. Afterward, the Roles page appears, showing only local roles for the current PDB and common roles. (You cannot drop common roles from a PDB.)
3. Select the local role you want to drop and then click **Delete**.  
Enterprise Manager prompts you to confirm deletion of the role.
4. Confirm that you want to delete the local role.

#### Related Topics

- [Logging into a Multitenant Environment in Enterprise Manager](#)  
In a multitenant environment, you can log in to a CDB or a PDB, and switch from a PDB to a different PDB or to the root.

## 29.3.8 Revoking Local Privilege Grants in Enterprise Manager

You can revoke local privileges in the PDB in which the privileges are used.

1. From the Enterprise Manager database home page, log in to the PDB as a common or local user who has the `CREATE USER` and `CREATE ROLE` privileges.
2. From the **Administration** menu, select **Security**, then **Users**.  
If prompted, enter your login information. Afterward, the Users page appears. In a PDB, both common and local users are listed.
3. Select the user whose privileges you want to revoke and then click **Edit**.  
The Edit User page appears.
4. Select **Roles** or the appropriate **Privileges** tab.  
Enterprise Manager displays a list of roles and privileges assigned to this user.
5. Select **Edit List** and then remove the privileges as necessary.

6. Click the **OK** button.

#### **Related Topics**

- [Logging into a Multitenant Environment in Enterprise Manager](#)  
In a multitenant environment, you can log in to a CDB or a PDB, and switch from a PDB to a different PDB or to the root.
- [Granting or Revoking Privileges to Access a PDB](#)  
You can grant and revoke privileges for PDB access in a multitenant environment.

# Glossary

## application

Within an application root, an application is a named, versioned set of data and metadata created by a common user. An application might include an application common user, an application common object, or some multiple and combination of the preceding.

## application common object

A shared database object created while connected to an [application root](#). The metadata (for a metadata-linked object) or data (for a [data-linked common object](#)) is shared by application PDBs in the [application container](#).

## application common user

A [common user](#) created while connected to an [application root](#). The metadata (for a [metadata-linked common object](#)) or data (for a [data-linked common object](#)) is shared by application PDBs in the application container.

## application container

A named set of application PDBs plugged in to an application root. An application container may contain an application seed.

## application patch

In an [application container](#), a small change to an [application](#). Typical examples of patching include bug fixes and security patches. An application upgrade begins and ends with an `ALTER PLUGGABLE DATABASE APPLICATION` statement.

## application PDB

A [PDB](#) that is plugged in to an [application container](#).

## application root

The root container within an application container. Every [application container](#) has exactly one application root. An application root shares some characteristics with the [CDB root](#), because it can contain common objects, and some characteristics with a [PDB](#), because it is created with the `CREATE PLUGGABLE DATABASE` statement.

## application seed

An optional [application PDB](#) that serves as a template for creating other PDBs within an [application container](#). An application container includes 0 or 1 application seed.

**application upgrade**

In an [application container](#), a major change to the physical architecture of an [application](#). An application upgrade begins and ends with an `ALTER PLUGGABLE DATABASE APPLICATION` statement.

**CDB**

An Oracle Database installation that contains at least one [PDB](#). A PDB appears to an Oracle Net client as a traditional Oracle database. Every Oracle database is either a CDB or a [non-CDB](#).

**CDB administrator**

A database administrator who manages a CDB. A [PDB administrator](#) manages individual PDBs within the CDB.

**CDB fleet**

A collection of different CDBs that can be managed as one logical CDB.

**CDB restore point**

In a CDB, a restore point that is created when connected to the root, and when the `FOR PLUGGABLE DATABASE` clause is not specified. Unlike a PDB restore point, a CDB restore point is usable by all PDBs.

**CDB root**

In a [multitenant container database \(CDB\)](#), a collection of schemas, schema objects, and nonschema objects to which all PDBs belong. Every CDB has exactly one root [container](#), which stores the system metadata required to manage PDBs. All PDBs belong to the CDB root.

**clean restore point**

A PDB restore point that is created when the PDB is closed. A Flashback PDB to a clean restore point does not require restoring backups or creating a temporary instance.

**common object**

An object that resides either in the [CDB root](#) or an [application root](#) that shares either data (a [data-linked common object](#)) or metadata (a [metadata-linked common object](#)). All common objects in the CDB root are Oracle-supplied. A common object in an application root is called an [application common object](#).

**common user**

In a [multitenant container database \(CDB\)](#), a database user that exists with the same identity in multiple containers. A common user created in the [CDB root](#) has the same identity in every existing and future [PDB](#). A common user created in an [application container](#) has the same identity in every existing and future [application PDB](#) in this [application container](#).

**container**

In a [multitenant container database \(CDB\)](#), either the root or a PDB.

**container data object**

In a CDB, a table or view containing data pertaining to multiple containers and possibly the CDB as a whole, along with mechanisms to restrict data visible to specific common users through such objects to one or more containers. Examples of container data objects are Oracle-supplied views whose names begin with V\$ and CDB\_.

**cross-container operation**

In a CDB, a DDL statement that affects the CDB itself, multiple containers, multiple common users or roles, or a container other than the one to which the user is connected. Only a common user connected to the root can perform cross-container operations.

**data link**

In a [PDB](#), an internal mechanism that points to data (not metadata) in the root. For example, AWR data resides in the root. Each PDB uses an object link to point to the AWR data in the root, thereby making views such as DBA\_HIST\_ACTIVE\_SESS\_HISTORY and DBA\_HIST\_BASELINE accessible in each separate container.

**database consolidation**

The general process of moving data from one or more non-CDBs into a [multitenant container database \(CDB\)](#).

**data-linked common object**

A [common object](#) that exists either in the [CDB root](#) or an [application root](#). The data, rather than the metadata, is shared by any PDB that contains a [data link](#) that points to the common object.

**extended data-linked common object**

A hybrid of a [data-linked common object](#) and a [metadata-linked common object](#). For an extended data-linked object, each [application PDB](#) can create its own PDB-specific data while sharing the common data in the [application root](#).

**hot cloning**

Cloning a PDB while the source PDB is open in read/write mode.

**lead CDB**

In a [CDB fleet](#), the central location for monitoring and managing several CDBs.

**local undo mode**

The use of a separate set of undo data files for each [PDB](#) in a [CDB](#).

**local user**

In a [multitenant container database \(CDB\)](#), any user that is not a [common user](#).

**metadata link**

In a [PDB](#), an internal mechanism that points to a dictionary object definition stored in the root. For example, the `OBJ$` table in each PDB uses a metadata link to point to the definition of `OBJ$` stored in the root.

**metadata-linked common object**

A [common object](#) that exists either in the [CDB root](#) or an [application root](#). The metadata, rather than the data, is shared by any PDB that contains a [metadata link](#) that points to the common object.

**multitenant architecture**

The architecture that enables an Oracle database to function as a multitenant container database ([CDB](#)), which means that it can contain multiple PDBs. A [PDB](#) is a portable collection of schemas, schema objects, and nonschema objects that appears to an Oracle Net client as a traditional Oracle database ([non-CDB](#)).

**multitenant container database (CDB)**

See [CDB](#).

**non-CDB**

An Oracle database that is not a [multitenant container database \(CDB\)](#). Before Oracle Database 12c, all databases were non-CDBs. Starting in Oracle Database 12c, every database must be either a CDB or a non-CDB.

**Oracle Multitenant**

A database option that enables you to create multiple PDBs in a CDB.

**PDB**

In a [multitenant container database \(CDB\)](#), a portable collection of schemas, schema objects, and nonschema objects that appears to an Oracle Net client as a traditional Oracle database ([non-CDB](#)).

**PDB administrator**

A database administrator who manages one or more PDBs. A [CDB administrator](#) manages the whole CDB.

**PDB archive file**

A compressed file that contains both [PDB](#) data files and an XML metadata file. You can create a PDB by specifying the archive file, and thereby avoid copying the XML file and the data files separately.

**PDB lockdown profile**

A security mechanism to restrict operations that are available to local users connected to a specified PDB. A typical use is to limit the effect of a grant privilege. For example, you limit the grant of `ALTER SYSTEM` to only those options whose names begin with `PLSQL`.

**PDB performance profile**

A specified share of system resources, CPU, parallel execution servers, and memory for a PDB or set of PDBs.

**PDB restore point**

Within a CDB, a restore point that usable only for a specific PDB. In contrast, a CDB restore point is usable by all PDBs.

**PDB snapshot**

A named copy of a PDB at a specific point in time. At the file level, the snapshot is an archive file containing the contents of the PDB copy.

**PDB synchronization**

The user-initiated update of the [application](#) in an [application PDB](#) to the latest version and patch in the [application root](#).

**PDB/non-CDB compatibility guarantee**

In the multitenant architecture, the guarantee that a PDB behaves the same as a non-CDB as seen from a client connecting with Oracle Net.

**pluggable database (PDB)**

See [PDB](#).

**proxy PDB**

A PDB that references a PDB in a remote CDB using a database link. The remote PDB is called a [referenced PDB](#).

**referenced PDB**

The PDB that is referenced by a [proxy PDB](#). A local PDB is in the same CDB as its referenced PDB, whereas a remote PDB is in a different CDB.

**refreshable clone PDB**

A read-only clone that can periodically synchronize with its source PDB. Depending on the value in the `REFRESH MODE` clause, the synchronization occurs either automatically or manually.

**resource plan**

A container for resource plan directives that specify how resources are allocated to resource consumer groups.

**resource plan directive**

A set of limits and controls for CPU, physical I/O, or logical I/O consumption for sessions in a consumer group.



**seed PDB**

In a [multitenant container database \(CDB\)](#), a default [pluggable database \(PDB\)](#) that the system uses as a template for user-created PDBs. A PDB seed is either the system-supplied `PDB$SEED` or an [application seed](#).

**shared undo mode**

In a single-instance CDB, only one active undo tablespace exists. For an Oracle RAC CDB, one active undo tablespace exists for every instance.

**snapshot copy PDB**

A [PDB](#) that is cloned using the `SNAPSHOT COPY` clause. When creating a snapshot copy, Oracle Database does not make a complete copy of the source data files. Rather, Oracle Database creates a storage-level snapshot of the underlying file system, and then uses the snapshot to create PDB clones. Unlike a standard clone PDB, a snapshot copy PDB cannot be unplugged from the [CDB root](#) or plugged in to an [application root](#).

**split mirror clone PDB**

A PDB that is created by splitting a mirror in Oracle ASM.

**system container**

The container that includes the CDB root and all PDBs in the CDB.

**unplugged PDB**

A self-contained set of [PDB](#) data files, and an XML metadata file that specifies the locations of the PDB files.

# Index

## A

---

- ADD\_OUTBOUND procedure, [24-12](#)
- administrative users
  - password files, multitenant environment, [13-21](#)
- ALTER DATABASE statement, [13-12](#)
  - application roots, [2-42](#), [17-4](#)
  - CDBs, [13-30](#)
  - RECOVER clause, [2-14](#)
- ALTER PLUGGABLE DATABASE statement,
  - [13-30](#), [15-21](#), [17-4](#)
  - DROP SNAPSHOT clause, [16-13](#)
  - MATERIALIZED clause, [7-28](#)
  - SET MAX\_PDB\_SNAPSHOTS clause, [16-5](#), [16-8](#)
  - SNAPSHOT clause, [16-9](#), [16-11](#)
  - SNAPSHOT COPY clause, [7-28](#)
  - UNPLUG INTO clause, [11-1](#), [12-7](#), [12-16](#)
- ALTER SESSION statement
  - SET CONTAINER clause, [13-24](#)
- ALTER SYSTEM statement
  - CDBs, [13-29](#)
  - CONTAINER clause, [13-29](#)
  - PDBs, [15-14](#)
- application common objects, [2-33](#), [2-44](#), [17-36](#), [17-37](#)
  - CONTAINERS clause, [17-50](#)
  - creation, [2-45](#), [17-38](#), [17-41](#)
  - data-linked, [2-7](#), [2-47](#)
  - DDL statements, [17-48](#)
  - DML statements, [17-44](#), [17-50](#)
  - extended data-linked objects, [2-48](#)
  - metadata links, [2-47](#)
  - metadata-linked common objects, [2-45](#)
  - naming rules, [2-17](#)
  - restrictions, [17-41](#)
- application containers
  - about, [2-38](#)
  - administering, [17-1](#), [17-2](#)
  - application common objects, [2-17](#), [2-33](#), [2-44](#), [2-45](#), [17-36](#), [17-41](#), [17-50](#)
  - application contexts, [18-2](#)
  - application PDBs, [2-43](#)
  - application roots, [2-42](#), [17-19](#)
  - application containers (*continued*)
    - application seeds, [2-43](#)
      - creating, [12-11](#), [12-13](#)
      - preparing for, [12-12](#)
    - application synchronization, [2-58](#)
    - application versions, [2-55](#)
    - applications, [2-51](#), [2-52](#)
    - applications created implicitly, [2-58](#)
    - bulk inserts, [17-32](#)
    - compatibility version, [17-31](#)
    - container maps, [2-59](#), [17-52](#)
      - creating, [17-55](#)
    - creating, [12-2](#), [12-4](#)
    - DML statements, [17-49](#), [17-50](#)
    - dropping, [12-9](#)
    - how an application upgrade works, [2-53](#)
    - installing applications, [2-50](#), [2-51](#), [17-10](#)
    - managing applications, [17-7](#)
    - migrating an application, [2-57](#)
    - migrating applications into, [17-17](#)
    - naming rules, [2-6](#)
    - patching applications, [2-56](#), [17-15](#), [17-16](#)
    - preparing for, [12-3](#)
    - purpose, [2-39–2-41](#)
    - SQL\*Loader, [17-32](#)
    - synchronizing applications, [17-21](#)
    - synchronizing with proxy PDBs, [17-22](#)
    - Transport Layer Security, [18-21](#)
    - uninstalling applications, [17-34](#), [17-35](#)
    - unplugging, [12-7](#)
    - upgrading applications, [2-50](#), [2-52](#), [17-12](#)
    - viewing extended data-linked objects, [19-30](#)
    - viewing information about, [19-23](#)
    - viewing patches, [19-27](#), [19-28](#)
    - viewing shared objects, [19-29](#)
    - viewing SQL statements, [19-25](#)
    - viewing status, [19-24](#)
    - viewing synchronization errors, [19-29](#)
    - views, [19-22](#)
    - Virtual Private Database policies, [18-21](#)
- application contexts
  - about, [18-18](#)
  - application containers, [18-18](#)
  - CDBs, [18-18](#)

- application PDBs, [2-43](#)
    - application synchronization, [2-58](#)
    - cloning, [7-6](#)
    - creating, [12-20](#), [17-20](#)
    - naming rules, [2-6](#)
    - synchronization, [2-59](#)
  - application roots, [2-42](#)
    - ALTER DATABASE statement, [17-4](#)
    - ALTER PLUGGABLE DATABASE statement, [17-4](#)
    - application PDBs
      - modifying, [17-4](#)
    - creating, [17-19](#)
    - modifying, [17-4](#)
  - application seeds, [1-13](#), [2-3](#), [2-43](#)
    - creating, [12-11](#), [12-13](#)
    - dropping, [12-18](#)
    - preparing for, [12-12](#)
    - unplugging, [12-16](#)
  - applications
    - in a CDB
      - metadata-linked common objects, [2-45](#)
    - in application containers, [2-50–2-53](#)
      - at different versions, [2-55](#)
      - created implicitly, [2-58](#)
      - migrating an application, [2-57](#)
      - patching, [2-56](#), [17-16](#)
      - synchronization, [2-58](#)
    - uninstalling, [17-35](#)
  - auditing
    - audit configurations, [2-34](#)
    - audit policies, [2-34](#)
    - CDBs, [18-22](#)
    - common objects, [2-34](#)
    - traditional, [18-24](#)
  - AVAILABILITY MAX clause, [8-7](#)
  - AVAILABILITY NORMAL clause, [8-6](#)
- ## B
- 
- backup and recovery
    - CDBs and PDBs, [2-69](#), [20-1](#)
- ## C
- 
- catcon.pl, [13-56](#)
  - CDB resource plans, [21-12](#)
    - PDB performance profiles, [21-21](#), [21-31](#)
  - CDB\_PDB\_HISTORY view, [19-21](#)
  - CDB\_PDBS view, [19-8](#)
  - CDBs, [3-1](#), [1](#), [13-17](#), [13-50](#), [23-2](#)
    - about, [1-1](#)
    - administering, [13-1](#), [27-1](#)
    - ALTER DATABASE statement, [13-30](#)
  - CDBs (*continued*)
    - ALTER PLUGGABLE DATABASE statement, [13-30](#)
    - ALTER SYSTEM statement, [13-29](#)
    - application common objects, [2-17](#), [2-44](#), [2-45](#), [17-36](#), [17-38](#), [17-50](#)
      - querying, [19-18](#)
    - application containers, [2-38–2-41](#)
      - application common objects, [2-7](#), [17-38](#)
      - application upgrades, [2-53](#)
      - bulk inserts, [17-32](#)
      - compatibility version, [17-31](#)
      - creating, [12-2](#), [12-4](#)
      - DML statements, [17-49](#)
      - dropping, [12-9](#)
      - installing applications, [2-50](#), [2-51](#), [17-10](#)
      - migrating applications into, [17-17](#)
      - patching applications, [17-15](#)
      - preparing for, [12-3](#)
      - synchronizing applications, [17-21](#)
      - uninstalling applications, [17-34](#), [17-35](#)
      - unplugging, [12-7](#)
      - upgrading applications, [2-52](#), [17-12](#)
    - application contexts, [18-18](#)
    - application PDBs, [2-43](#)
      - cloning, [7-6](#)
      - creating, [12-20](#), [17-20](#)
    - application seeds, [2-43](#)
      - creating, [12-11](#)
      - dropping, [12-18](#)
      - preparing for, [12-12](#)
      - unplugging, [12-16](#)
    - auditing, [18-22](#)
      - how affects, [18-22](#)
      - traditional, [18-24](#)
    - backup and recovery, [2-69](#), [20-1](#)
    - CDB fleets, [14-1](#), [14-3](#)
      - CDB member, [14-4](#)
      - lead CDB, [14-1](#), [14-4](#)
    - CDB resource plans
      - viewing information about, [21-38](#)
    - character sets, [2-2](#)
    - common objects, [2-7](#), [2-33](#)
    - common privilege grants, [2-27](#), [2-30](#), [18-3](#)
    - common roles, [2-23](#)
    - common users, [2-15](#), [2-18](#), [2-19](#), [2-27](#), [2-30](#)
      - definition, [3-2](#)
      - naming rules, [2-17](#)
    - compatibility violations, [13-38](#)
    - connecting to, [13-18](#)
      - ALTER SESSION statement, [13-24](#)
      - CONNECT command, [13-21](#)
    - container data objects, [2-11](#), [19-3](#)
      - querying, [19-10](#)
    - container maps, [2-59](#), [17-52](#)

CDBs (*continued*)

- containers, [1-1](#), [13-51](#), [19-8](#)
- CONTAINERS clause, [19-16](#)
- creating, [4-1](#), [4-10](#)
- creation, [1-11](#)
- cross-container operations, [2-14](#)
- current container, [2-14](#), [13-2](#), [19-19](#)
- data definition language (DDL), [13-53](#)
- data dictionary, [2-8](#)
- data links, [2-10](#)
- Data Redaction masking policies, [18-22](#)
- Database Resource Manager, [21-1](#)
- DBMS\_SQL package, [13-63](#)
- DML statements, [13-51](#), [17-50](#)
- EM Express, [4-23](#)
- ENABLE PLUGGABLE DATABASE clause, [4-12](#)
- executing PL/SQL code, [13-63](#)
- files, [2-66](#)
- flashback, [20-5](#)
- flashback of PDBs, [2-69](#)
- functionality in Oracle Database Vault, [23-2](#)
- granting common roles and privileges, [2-28](#)
- granting privileges and roles, [2-26](#), [18-5](#)
- initialization parameters, [19-20](#)
- local privilege grants, [18-3](#)
- local roles, [2-23–2-25](#)
- local users, [2-18](#), [2-21](#)
  - definition, [3-2](#)
- metadata links, [2-10](#)
- modifying, [13-29–13-31](#)
- monitoring, [19-1](#)
- object privileges, [18-4](#)
- Oracle Data Pump, [1-19](#)
- Oracle Database Vault, [13-3](#), [23-1](#)
- Oracle Managed Files, [4-14](#)
- PDB lockdown profiles, [2-35](#), [13-15](#), [18-12](#)
- PDB snapshots, [16-1](#)
  - configuring automatic creation, [16-9](#)
  - creating manually, [7-10](#), [16-11](#)
  - dropping, [16-13](#)
  - setting maximum number, [16-5](#), [16-8](#)
- PDB\_FILE\_NAME\_CONVERT initialization parameter, [4-14](#)
- PDBs
  - modifying, [13-30](#)
  - refreshing, [15-25](#)
- planning creation, [4-2](#)
- plugging in PDBs
  - methods for, [5-1](#)
  - preparing for, [5-21](#)
- point-in-time recovery, [20-4](#)
- prerequisites for, [3-2](#)
- principles of grants, [2-25](#)
- privilege management, [18-1](#)

CDBs (*continued*)

- realms, [23-11](#)
- recovering, [20-1](#)
- resource management, [2-70](#)
- revoking privileges, [18-5](#)
- roles
  - creating common, [18-9](#)
  - creating local, [18-10](#)
  - granting common, [2-27](#), [2-30](#), [18-10](#)
  - how common roles work, [18-8](#)
  - managing, [18-8](#)
  - privileges required to manage, [18-9](#)
  - rules for creating common, [18-9](#)
- root container, [2-2](#)
  - modifying, [13-36](#)
- rule sets, [23-13](#)
- security, [18-1](#)
- SEED FILE\_NAME\_CONVERT clause, [4-13](#)
- seed PDBs, [1-13](#), [2-3](#)
- services, [2-62](#)
- shutting down, [13-64](#)
- snapshot copy PDBs, [7-12](#)
  - materializing, [7-28](#)
- SQL scripts, [13-56](#)
- standby database, [13-3](#)
- system container, [2-2](#)
- system privileges, [18-3](#)
- tasks for, [3-3](#)
- temp files, [2-66](#)
- tools for, [3-6](#)
- Transparent Data Encryption, [13-3](#)
- undo mode, [2-66](#), [4-15](#), [13-32](#)
- unplugging PDBs, [11-1](#)
- user privileges, how affects, [18-2](#)
- viewing information about, [18-6](#), [19-1](#)
- views, [19-4](#)
- Virtual Private Database, [18-20](#)
  - policies, [18-21](#)
- XStream, [24-1](#)
- XStream In, [24-17](#)
- XStream Out, [24-7](#)
  - configuring, [24-9](#)
  - configuring multiple, [24-12](#)

CLONEDB parameter, [7-1](#)

- cloning a non-CDB, [7-5](#)
- cloning a PDB, [7-1](#)
  - local, [7-3](#), [7-14](#)
  - refreshable clone PDBs, [7-7](#), [15-26](#)
  - remote, [7-4](#), [7-22](#)
  - using split mirrors, [7-13](#)
- cloning an application PDB, [7-6](#)
- command rules
  - with PDBs, [23-13](#)
- common objects, [2-33](#)

- common privilege grants, [2-27](#), [2-30](#)
    - about, [18-3](#)
    - granting, [18-5](#)
    - revoking, [18-5](#)
    - with object privileges, [18-4](#)
    - with system privileges, [18-3](#)
  - common roles, [2-23](#)
    - about, [18-8](#)
    - creating, [18-9](#)
    - granting, [2-27](#), [2-30](#), [18-10](#)
    - how they work, [18-8](#)
    - privileges required to manage, [18-9](#)
    - rules for creating, [18-9](#)
  - common user accounts, [1-1](#), [2-15](#), [2-18](#)
    - definition, [3-2](#)
    - enabling access to other PDBs, [18-5](#)
    - granting privileges to, [2-27](#), [2-30](#), [18-1](#)
    - naming rules, [2-17](#)
  - common users, [2-19](#)
    - accessing data in PDBs, [18-7](#)
    - prefix, [13-53](#)
  - COMMON\_USER\_PREFIX parameter, [13-53](#)
  - commonality, principles of, [2-16](#)
  - CONFIGURE\_DV procedure
    - registering Database Vault with, [23-8](#)
  - CONNECT command, SQL\*Plus
    - CDBs, [13-21](#)
  - container data objects, [2-11](#), [19-3](#)
    - about, [18-6](#)
    - definition, [19-3](#)
    - querying, [19-10](#)
  - container databases
    - See CDBs
  - container maps, [2-59](#), [17-52](#)
    - creating, [17-55](#)
  - CONTAINER\_DATA objects
    - viewing information about, [18-5](#)
  - CONTAINERS clause, [17-37](#), [17-50](#), [19-16](#), [19-18](#)
  - CONTAINERS\_DEFAULT attribute, [17-37](#)
  - CONTAINERS\_DEFAULT\_TARGET property, [2-14](#)
  - CONTAINERS\_PARALLEL\_DEGREE
    - parameter, [19-16](#), [19-18](#)
  - containers, CDB, [1-1](#), [2-1](#), [2-69](#)
    - root, [2-2](#)
  - CPU\_COUNT initialization parameter, [21-11](#)
  - CREATE DATABASE statement
    - CDBs, [4-9](#)
    - ENABLE PLUGGABLE DATABASE clause, [4-12](#)
    - SEED FILE\_NAME\_CONVERT clause, [4-13](#)
    - undo\_mode\_clause*, [4-15](#)
  - CREATE LOCKDOWN PROFILE statement, [2-35](#), [18-14](#)
  - CREATE PLUGGABLE DATABASE statement, [1-13](#), [1-14](#), [2-3](#)
    - application containers, [2-38](#)
    - AS PROXY clause, [1-22](#), [2-5](#), [10-1](#)
    - clauses, [5-14](#)
    - DEFAULT TABLESPACE clause, [5-6](#)
    - file locations, [5-8](#)
    - HOST clause, [10-5](#)
    - logging\_clause, [15-17](#), [15-18](#)
    - MAX\_AUDIT\_SIZE clause, [5-5](#)
    - MAX\_DIAG\_SIZE clause, [5-5](#)
    - NO DATA clause, [7-14](#)
    - PATH\_PREFIX clause, [5-12](#)
    - PDB listener host name, [10-5](#)
    - PDB listener port number, [10-5](#)
    - pdb\_force\_logging\_clause, [15-17](#)
    - PORT clause, [10-6](#)
    - REFRESH MODE clause, [7-7](#)
    - RELOCATE clause, [1-20](#), [8-1](#), [8-9](#)
    - SERVICE\_NAME\_CONVERT clause, [5-13](#)
    - SNAPSHOT COPY clause, [1-16](#), [7-1](#), [7-12](#)
    - SNAPSHOT MODE clause, [16-6](#)
    - source file locations, [9-4](#)
    - SOURCE\_FILE\_DIRECTORY clause, [9-5](#)
    - SOURCE\_FILE\_NAME\_CONVERT clause, [9-4](#)
    - STORAGE clause, [5-5](#)
    - USER\_TABLESPACES clause, [5-6](#)
    - USING clause, [1-17](#), [9-8](#)
    - USING SNAPSHOT clause, [7-10](#)
  - CREATE ROLE statement, [2-23](#)
  - CREATE\_FILE\_DEST clause, [5-11](#), [7-18](#), [13-17](#)
  - CREATE\_SIMPLE\_PLAN procedure
    - Database Resource Manager, [21-43](#)
  - creating an application PDB, [17-20](#)
  - creating CDBs, [4-1](#)
    - CREATE DATABASE statement, [4-9](#)
    - Database Configuration Assistant, [4-10](#)
    - ENABLE PLUGGABLE DATABASE clause, [4-12](#)
    - manually from a script, [4-9](#)
    - Oracle Managed Files, [4-14](#)
    - PDB\_FILE\_NAME\_CONVERT initialization parameter, [4-14](#)
    - planning, [4-2](#)
    - SEED FILE\_NAME\_CONVERT clause, [4-13](#)
    - undo\_mode\_clause*, [4-15](#)
  - creating PDBs, [5-1](#)
  - cross-container operations, [2-14](#)
  - current container, [2-14](#), [13-2](#)
- ## D
- 
- data definition language (DDL)
    - CDBs, [13-53](#)

- data dictionary
    - CDBs, [2-8](#)
    - PDBs, [1-9](#)
    - storage in a CDB, [2-14](#)
  - data links, [2-10](#), [2-47](#)
  - data manipulation language
    - CDBs, [13-51](#)
  - data-linked application common objects, [2-45](#), [12-2](#)
  - data-linked common objects, [2-7](#), [2-44](#), [2-47](#), [17-37](#)
  - Database Configuration Assistant
    - CDBs, [4-10](#)
  - database consolidation, [1-7](#)
  - database links, PDBs, [2-7](#)
  - Database Resource Manager, [1-7](#)
    - CDB resource plans, [21-12](#)
    - CDBs, [2-70](#), [21-1](#)
    - CREATE\_SIMPLE\_PLAN procedure, [21-43](#)
    - monitoring PDBs, [21-46](#)
    - PDB resource plans, [21-41](#)
    - PDBs, [21-1](#)
  - database services, [2-63](#), [2-64](#)
    - in a CDB, [2-64](#)
    - PDBs, [2-62](#)
  - Database Upgrade Assistant (DBUA)
    - multitenant architecture support, [1-4](#)
  - Database Vault
    - See Oracle Database Vault
  - DB\_CACHE\_SIZE parameter, [21-6](#)
  - DB\_CREATE\_FILE\_DEST initialization parameter, [5-11](#)
  - DB\_PERFORMANCE\_PROFILE parameter, [21-22](#)
  - DBA\_APP\_ERRORS view, [19-29](#)
  - DBA\_APP\_PATCHES view, [19-28](#)
  - DBA\_APP\_PDB\_STATUS view, [19-24](#)
  - DBA\_APP\_STATEMENTS view, [19-25](#)
  - DBA\_APP\_VERSIONS view, [19-27](#)
  - DBA\_APPLICATIONS view, [19-23](#)
  - DBA\_CONTAINER\_DATA data dictionary view, [18-6](#)
  - DBA\_OBJECTS view, [17-19](#)
    - shared objects, [19-29](#)
  - DBA\_PDB\_SAVED\_STATES view, [13-48](#)
  - DBA\_PROFILES view, [17-19](#)
  - DBA\_ROLES view, [17-19](#)
  - DBA\_TABLES view
    - extended data-linked objects, [19-30](#)
  - DBA\_USERS view, [17-19](#)
  - DBMS\_CREDENTIAL package, [13-16](#)
  - DBMS\_JOB
    - using with PDB, [22-3](#)
  - DBMS\_MACADM.ENABLE\_DV procedure
    - registering Database Vault with, [23-5](#), [23-8](#)
  - DBMS\_PDB package, [1-19](#), [5-1](#), [5-4](#), [7-22](#), [9-6](#), [17-19](#)
  - DBMS\_SCHEDULER package, [22-3](#)
  - DBMS\_SQL package
    - CDBs, [13-63](#)
  - DEFAULT TABLESPACE clause, [5-6](#)
  - default temporary tablespaces
    - specifying for root, [4-18](#), [4-21](#)
  - DESCRIBE procedure, [9-6](#)
  - direct-path load, [1-19](#)
  - DROP PLUGGABLE DATABASE statement, [11-5](#), [12-9](#), [12-18](#)
  - DVSYSS schema
    - CDBs, [23-2](#)
- ## E
- 
- EM Express, [1-4](#)
    - CDBs, [4-23](#)
  - ENABLE PLUGGABLE DATABASE clause, [4-12](#)
  - ENABLE\_PLUGGABLE\_DATABASE initialization parameter, [4-16](#)
  - Enterprise Manager
    - multitenant architecture support, [1-4](#)
  - extended data-linked application common objects, [12-2](#)
  - extended data-linked objects, [2-48](#), [17-37](#)
- ## F
- 
- FILE\_NAME\_CONVERT clause, [7-18](#)
  - Flashback PDB, [2-69](#), [13-14](#)
  - fleets, CDB, [14-1](#), [14-3](#)
- ## H
- 
- HOST clause, [10-5](#)
- ## I
- 
- installations
    - Database Vault and Label Security in a multitenant environment, [23-4](#)
- ## L
- 
- lead CDB, [14-1](#)
  - LEAD\_CDB database property, [14-4](#)
  - LEAD\_CDB\_URI database property, [14-4](#)
  - local privilege grants
    - about, [18-3](#)
    - granting, [18-5](#)
    - revoking, [18-5](#)

local privileges  
 granting, [2-26](#)  
 local roles, [2-23–2-25](#)  
 about, [18-8](#)  
 creating, [18-10](#)  
 granting, [2-26](#)  
 rules for creating, [18-10](#)  
 local users, [2-18, 2-21](#)  
 definition, [3-2](#)  
 lockdown profiles, PDB, [2-35, 18-12](#)  
 logging\_clause, [15-17, 15-18](#)  
 logical change records (LCRs), [24-1](#)

## M

---

MAX\_AUDIT\_SIZE clause, [5-5](#)  
 MAX\_DIAG\_SIZE clause, [5-5](#)  
 MAX\_IOPS parameter, [21-9](#)  
 MAX\_MBPS parameter, [21-9](#)  
 MAX\_PDB\_SNAPSHOTS database property, [16-1](#)  
 metadata links, [2-10, 2-47](#)  
 metadata-linked application common objects, [2-45, 12-2](#)  
 metadata-linked common objects, [2-44, 2-45, 17-37](#)  
 metadata links, [2-47](#)  
 multitenant architecture, [1-1, 3-1, 1](#)  
 benefits, [1-6, 1-7, 1-9](#)  
 overview, [2-1](#)  
 user interfaces, [1-4](#)  
 XStream In, [24-17](#)  
 XStream Out, [24-7](#)  
 multitenant container database  
 See CDBs  
 multitenant container databases  
 See CDBs  
 multitenant environment, [3-1](#)

## N

---

NO DATA clause, [7-14](#)  
 non-CDBs, [1-1, 1-6](#)  
 cloning as CDBs, [1-19](#)  
 cloning as PDBs, [1-14, 7-1, 7-5, 7-22](#)  
 moving to PDBs, [5-4](#)  
 noncdb\_to\_pdb.sql script, [1-19, 7-22, 9-11](#)

## O

---

object privileges  
 with common privilege grants, [18-4](#)  
 open modes  
 PDBs, [13-37](#)  
 ORA-47503 error, [23-8](#)

Oracle ASM, [5-11, 7-13](#)  
 Oracle Data Guard  
 CDBs, [13-3](#)  
 Oracle Data Pump, [1-19, 5-4](#)  
 Oracle Data Redaction  
 CDBs, [18-22](#)  
 Oracle Database Configuration Assistant (DBCA), [1-4](#)  
 Oracle Database Vault, [23-2](#)  
 about, [23-2](#)  
 CDBs, [13-3, 23-1](#)  
 Oracle Database Vault policies  
 in multitenant environment, [23-14](#)  
 Oracle Database Vault registration  
 common user to manage CDB root, [23-5](#)  
 common users to manage specific PDBs, [23-8](#)  
 plugging in a Database Vault-enabled database, [23-10](#)  
 verifying configuration and enablement, [23-5](#)  
 Oracle Enterprise Manager  
 PDBs, [29-1](#)  
 Oracle Enterprise Manager Database Express  
 See EM Express  
 Oracle GoldenGate, [1-19, 5-4](#)  
 Oracle Managed Files, [4-14, 5-11](#)  
 Oracle Multitenant, [13-17](#)  
 Oracle Multitenant option, [1-1, 1](#)  
 Oracle Streams, [24-1](#)  
 Oracle Universal Installer, [4-1](#)  
 Oracle Virtual Private Database, [18-20](#)  
 CDBs, [18-20](#)  
 Oracle Virtual Private Database (VPD)  
 about, [18-20](#)  
 application containers, [18-21](#)  
 CDBs, [18-21](#)

## P

---

PATH\_PREFIX clause, [5-12, 7-18, 13-17](#)  
 PDB lockdown profiles  
 about, [18-12](#)  
 creating, [18-14](#)  
 default, [18-13](#)  
 disabling, [18-15](#)  
 dropping, [18-17](#)  
 enabling, [18-15](#)  
 PDB performance profiles, [21-21](#)  
 managing, [21-31](#)  
 PDB relocation  
 basic steps, [8-9](#)  
 how it works, [8-4](#)  
 PDB resource plans, [21-41](#)  
 PDB snapshot carousel  
 about, [16-1](#)



PDB snapshot carousel (*continued*)

- administering, [16-1](#)
- contents, [16-5](#)
- how it works, [16-4](#)
- purpose, [16-2](#)
- setting the maximum number of snapshots, [16-8](#)

PDB\_FILE\_NAME\_CONVERT initialization parameter, [4-14](#), [7-22](#)pdb\_force\_logging\_clause, [15-17](#), [15-18](#)PDB\_OS\_CREDENTIAL initialization parameter, [13-15](#), [13-16](#)PDB\_PLUG\_IN\_VIOLATIONS view, [13-38](#)pdb\_save\_or\_discard\_state clause, [13-48](#)pdb\_to\_apppdb.sql script, [17-20](#)PDB\$SEED, [2-3](#)PDBs, [3-1](#), [1](#), [13-17](#), [13-50](#), [23-2](#)

- about, [1-1](#)
- administering, [15-1](#)
- ALTER SYSTEM statement, [15-14](#)
- archive files, [1-17](#)
- auditing
  - types of audit settings allowed, [18-22](#)
- backup and recovery, [2-69](#)
- benefits, [1-6](#)
- buffer pool size, [21-6](#)
- CDB resource plans, [21-12](#)
  - creating, [21-18](#), [21-21](#)
  - directives, [21-16](#)
  - disabling, [21-37](#)
  - enabling, [21-25](#)
  - managing, [21-26](#)
  - shares, [21-12](#)
  - utilization limits, [21-13](#)
  - viewing information about, [21-38](#)
- character sets, [2-2](#)
- cloning, [1-14](#), [2-5](#), [7-1](#)
- cloning application, [7-6](#)
- cloning local, [7-3](#), [7-4](#), [7-14](#)
- command rules in, [23-13](#)
- common roles
  - about, [18-8](#)
  - creating, [18-9](#)
  - granting, [18-10](#)
  - how they work, [18-8](#)
  - privileges required for management, [18-9](#)
  - revoking, [18-10](#)
  - rules for creating, [18-9](#)
- common users, [2-17](#)
  - accessing data in PDBs, [18-7](#)
  - viewing privilege information, [18-6](#)
- compatibility violations, [13-38](#)
- connecting to, [2-65](#), [13-18](#), [15-4](#)
  - ALTER SESSION statement, [13-24](#)
  - CONNECT command, [13-21](#)

PDBs (*continued*)

- consolidation of data into, [1-10](#)
- containers, [2-1](#)
- CPU limits, [21-11](#)
- creating as proxies, [10-1](#)
- creating by plugging in, [1-19](#), [9-8](#)
- creating from seed, [1-13](#), [6-1](#)
- creating with Cloud Control, [26-4](#)
- creation, [1-12](#), [5-1](#)
- current container, [2-14](#), [13-2](#)
- data dictionary, [1-9](#)
- Data Redaction policies, [18-22](#)
- database links, [2-7](#)
- Database Resource Manager, [21-1](#)
- DBMS\_SQL package, [13-63](#)
- definition, [2-3](#), [3-1](#)
- dropping, [11-5](#)
- EM Express, [4-23](#)
- encryption, [7-1](#)
- Enterprise Manager
  - about, [29-1](#)
  - creating common roles, [29-6](#)
  - creating common users, [29-2](#)
  - creating local roles, [29-8](#)
  - creating local users, [29-4](#)
  - dropping common roles, [29-7](#)
  - dropping common users, [29-3](#)
  - dropping local roles, [29-9](#)
  - dropping local users, [29-5](#)
  - editing common roles, [29-6](#)
  - editing common users, [29-3](#)
  - editing local roles, [29-8](#)
  - editing local users, [29-4](#)
  - logging in, [25-1](#)
  - revoking common privilege grants, [29-7](#)
  - revoking local privilege grants, [29-9](#)
  - switching to different container, [25-2](#)
- executing PL/SQL code, [13-63](#)
- fine-grained audit policies, [18-28](#)
- flashback, [2-69](#), [13-14](#), [20-5](#)
- granting privileges and roles, [2-24](#)
- hot cloning, [7-1](#)
- I/O limits, [21-9](#)
- instances\_clause, [13-39](#)
- keystore, [7-1](#)
- local roles
  - about, [18-8](#)
  - creating, [18-10](#)
  - rules for creating, [18-10](#)
- lockdown profiles, [2-35](#), [13-15](#)
- managing, [13-50](#)
- modifying, [15-16](#)
- moving, [8-1](#), [8-6](#), [8-7](#)
  - how it works, [8-4](#)
  - purpose, [8-4](#)



PDBs (*continued*)

- moving non-CDBs into, [5-4](#), [9-6](#)
- naming rules, [2-6](#)
- open mode, [13-37](#), [19-9](#)
  - preserving on restart, [13-48](#)
- PDB resource plans, [21-41](#)
  - creating, [21-43](#)
  - disabling, [21-46](#)
  - enabling, [21-44](#)
  - modifying, [21-45](#)
- PGA size, [21-6](#)
- plugging Database Vault-enabled PDB to CDB, [23-14](#)
- plugging in, [9-1](#)
  - methods for, [5-1](#)
  - preparing for, [5-21](#)
- point-in-time recovery, [20-4](#)
- prerequisites for, [3-2](#)
- privileges
  - common, [18-3](#)
  - granting, [18-5](#)
  - how affected, [18-2](#)
  - object, [18-4](#)
  - revoking, [18-5](#)
  - viewing information about, [18-6](#)
- proxy, [1-12](#), [1-22](#), [2-3](#), [2-5](#), [10-4](#), [17-22](#)
- PUBLIC role, [18-9](#)
- purpose of, [2-5](#)
- refreshable clone, [1-16](#)
- refreshing, [15-25](#)
- relocate\_clause*, [13-39](#)
- relocating, [1-20](#), [8-1](#), [8-6](#), [8-7](#), [8-9](#)
  - how it works, [8-4](#)
  - purpose, [8-4](#)
- renaming, [15-24](#)
- resource management, [2-70](#)
- restore points, [2-69](#)
- services, [2-62–2-64](#), [15-5](#)
- services\_clause*, [13-39](#)
- SGA size, [21-6](#)
- shared pool size, [21-6](#)
- SHUTDOWN command, [15-30](#), [15-31](#)
- shutting down, [13-64](#)
- snapshot copy, [1-16](#), [7-12](#)
- snapshots, [7-28](#), [16-1](#), [16-5](#), [16-6](#), [16-8](#), [16-9](#), [16-11](#), [16-13](#)
- STARTUP command, [13-47](#), [15-30](#)
- tasks for, [3-3](#)
- temp files, [2-66](#)
- tools for, [3-6](#)
- types, [2-3](#)
- unplugged, [1-17](#)
- unplugging, [11-1](#)
- viewing information about, [18-6](#)
- views, [19-4](#)

PDBs (*continued*)

- Virtual Private Database policies, [18-21](#)
- XStream In, [24-17](#)
- XStream Out, [24-7](#)
  - configuring, [24-9](#)
- PGA\_AGGREGATE\_LIMIT parameter, [21-6](#)
- PGA\_AGGREGATE\_TARGET parameter, [21-6](#)
- pluggable database
  - See PDBs
- pluggable databases
  - See PDBs
- plugging in unplugged PDBs, [9-8](#)
- PORT clause, [10-6](#)
- privileges
  - granting common, [2-27](#), [2-28](#), [2-30](#)
  - granting in a CDB, [2-24](#), [2-25](#)
  - local, [2-26](#)
- proxy PDBs, [1-12](#), [1-22](#), [2-3](#), [2-5](#), [2-7](#), [10-1](#)
  - creating, [17-25](#)
  - referenced PDB
    - altering listener host name, [15-12](#)
    - altering listener port number, [15-13](#)
  - synchronizing an application root replica, [17-22](#)
- PUBLIC role, CDBs, [18-9](#)

## R

---

- realms
  - authorizations in multitenant environment, [23-12](#)
  - multitenant environment
    - about, [23-11](#)
- recovering CDBs, [20-1](#)
- REFRESH MODE clause, [7-7](#)
- refreshable clone PDBs, [1-16](#), [7-7](#)
  - switchover, [15-26](#)
- relocating PDBs, [8-1](#)
  - common listener network, [8-6](#)
  - isolated listener network, [8-7](#)
- REMOTE\_RECOVERY\_FILE\_DEST parameter, [7-7](#)
- resource plans
  - CDB, [21-12](#)
  - PDB, [21-41](#)
- roles
  - common, [2-28](#)
  - common, granting, [18-10](#)
  - granting in a CDB, [2-24](#), [2-25](#)
  - in a CDB, [2-23](#)
  - local, [2-24–2-26](#)
- root container, [1-1](#), [1-11](#), [2-2](#)
  - modifying, [13-36](#)
  - viewing information about, [18-6](#)
- row-level security

See fine-grained access control, Oracle Virtual Private Database (VPD)

rsmgr:io rate limit, [21-9](#)

rule sets

multitenant environment

about, [23-13](#)

rule-based transformations, [24-1](#)

rules, [24-1](#)

## S

Scheduler

CDB, [22-1](#)

closing a PDB, [22-3](#)

invocations to CDB, [22-1](#)

using job coordinator in CDB, [22-2](#)

using slave processes in CDB, [22-2](#)

views, [22-3](#)

security

CDBs, [18-1](#)

PDBs, [13-14](#)

SEED\_FILE\_NAME\_CONVERT clause, [4-13](#)

seed PDB, [1-1](#), [1-11](#)

SERVICE\_NAME\_CONVERT clause, [5-13](#), [7-18](#)

services

PDBs, [15-5](#)

SGA\_MIN\_SIZE parameter, [21-6](#)

SGA\_TARGET parameter, [21-6](#)

SHARED\_POOL\_SIZE parameter, [21-6](#)

SHUTDOWN command

closing a PDB, [15-30](#)

PDBs, [15-31](#)

shutting down an instance

CDBs, [13-64](#)

SNAPSHOT COPY clause, [1-16](#), [7-1](#), [7-12](#)

snapshot copy PDBs, [1-16](#)

SNAPSHOT MODE clause, [16-6](#)

snapshots, PDB, [16-1](#)

contents, [16-5](#)

SOURCE\_FILE\_DIRECTORY clause, [9-5](#)

SOURCE\_FILE\_NAME\_CONVERT clause, [9-4](#)

split mirror clone PDBs, [7-13](#)

SQL scripts

CDBs, [13-56](#)

SQL\*Loader

application containers, [17-32](#)

SQL\*Plus

multitenant architecture support, [1-4](#)

standby database

CDBs, [13-3](#)

STANDBY\_PDB\_SOURCE\_FILE\_DBLINK

initialization parameter, [7-22](#)

STANDBY\_PDB\_SOURCE\_FILE\_DIRECTORY

initialization parameter, [9-8](#)

STARTUP command

PDBs, [13-47](#), [15-30](#)

starting a PDB, [15-30](#)

STORAGE clause, [5-5](#)

switching over refreshable clone PDBs, [15-26](#)

synchronizing applications, [17-21](#)

system container, [2-2](#)

system privileges

CDBs, [18-3](#)

with common privilege grants, [18-3](#)

## T

Transparent Data Encryption

CDBs, [13-3](#)

Transport Layer Security (TLS)

application containers, [18-21](#)

## U

undo mode

CDBs, [2-66](#), [13-32](#)

undo tablespaces, [13-12](#)

specifying for CDBs, [4-18](#), [4-21](#)

*undo\_mode\_clause*, [4-15](#)

unified audit policies, application containers

example, [18-27](#)

unified audit policies, CDBs

about, [18-24](#)

appearance in audit trail, [18-27](#)

configuring, [18-25](#)

examples, [18-26](#)

unified audit policies, roles

examples, [18-23](#)

unplugging, [11-1](#), [12-7](#), [12-16](#)

upgrades

database, [1-7](#), [2-9](#)

user privileges

CDBs, [18-2](#)

USER\_TABLESPACES clause, [5-6](#)

users

common, [1-1](#), [2-17](#), [2-19](#)

user name, specifying with CREATE USER

statement, [13-20](#)

USING SNAPSHOT clause, [7-10](#)

utilization limits for PDBs, [21-13](#)

## V

V\$CON\_SYS\_TIME\_MODEL view, [19-3](#)

V\$CON\_SYSSTAT view, [19-3](#)

V\$CON\_SYSTEM\_EVENT view, [19-3](#)

V\$CON\_SYSTEM\_WAIT\_CLASS view, [19-3](#)

V\$CONTAINERS view, [19-8](#)

V\$PDBS view, [15-18](#), [19-8](#), [19-9](#)

V\$RSRCPDBMETRIC view, [21-46](#)

  CPU usage, [21-48](#)

  I/O generated, [21-50](#)

  memory usage, [21-51](#)

  parallel execution, [21-49](#)

V\$RSRCPDBMETRIC\_HISTORY view, [21-46](#)

Virtual Private Database

  See Oracle Virtual Private Database

VPD

  See Oracle Virtual Private Database

## X

---

XStream

  CDBs, [24-1](#)